



Product Catalogue 2018

Professional
tool solutions



1 | Factory and workshop equipment, sets of tools
→ Page 3



1

2 | Spanners
→ Page 75



2

3 | Sockets, Socket sets, Accessories for manual drives
→ Page 99



3

4 | IMPACT sockets, Accessories, machine actuated
→ Page 155



4

5 | Torque tools, Torque testers
→ Page 175



5

6 | Screwdrivers
→ Page 235



6

7 | Pliers
→ Page 251



7

8 | Pipe cutters, Hammers, Chisels, Files,
Miscellaneous tools
→ Page 277



8

9 | Pullers
→ Page 297



9

10 | Special automotive tools
→ Page 305



10

11 | VDE tools
→ S. 349



11



1 | FACTORY AND WORKSHOP EQUIPMENT, SETS OF TOOLS

TOOL TROLLEYS, WORKBENCHES AND ACCESSORIES

→ PAGE 4



CONVERTA AND ACCESSORIES

→ PAGE 15



TOOL BOXES, TOOL CASES AND ACCESSORIES

→ PAGE 17



SETS OF TOOLS

→ PAGE 25



SALES AIDS AND ACCESSORIES

→ PAGE 72



1

More than just standard. Tool Trolley No 90.



Tool Trolley No 90 is the perfect, mobile storage system for your tools. Key features are the resilient worktop made of ABS plastic and drawers mounted in full-extension runners. The overall design and paint finish in RAL 7016 blend in harmoniously in any production or workshop environment.

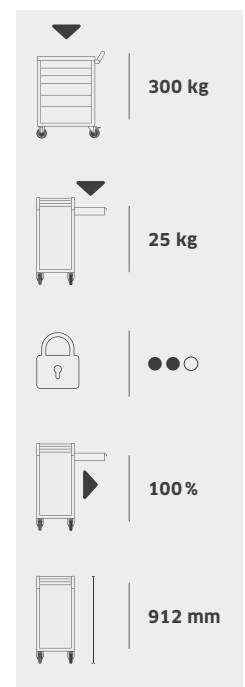

1

Particularly tough, oil and Skydrol resistant worktop made of ABS with compartments for small components.

2

Two-stage safety logic:

- Central locking with a cylinder lock and fold-down key.
- Individual locks prevent inadvertent opening in transit.

3

Sturdy push-bar.

4

Six locking, easily removable drawers mounted in full-extension runners. Can be enhanced with STAHLWILLE Standard and TCS inlays.

5

Oil and acid resistant wheels (∅ 100 mm) with one parking brake.

Robust. Compact. Safe.

Tool Trolley No 95.



Model 95 provides even greater security and durability. The stainless steel handle with reinforced connections to the main body and wrap-around bumpers make it extremely robust. A further feature is the three-stage safety logic with central and individual locking together with a topple-proof mechanism to ensure maximum safety.

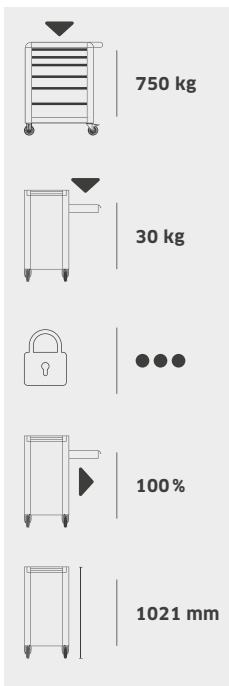

- 1** Three-stage safety logic:
 - Central locking with a lateral cylinder lock and fold-down key.
 - Individual locks prevent inadvertent opening in transit.
 - Topple-proof - it is not possible to pull out more than one drawer at a time.
- 2** Impact protection strips with wrap-around bumper.
- 3** Easily removable drawers mounted in full extension rails with bearing cage guidance.
- 4** Perforations from both sides for Hooks No 8031-8041, e.g. for larger tools.
- 5** Oil and acid resistant wheels (∅ 125 mm) with two parking brakes. Carpet protection prevents the ingress of dirt and threads into the bearings.

Individual needs

Five colour shades and options for 6, 7 or 8 drawers are available for Tool Trolleys 95, 95VA and 98VA.



1

Good is now better. Tool Trolley 95VA.



Using Model 95 as a starting point, we have enhanced many aspects of the design to produce Tool Trolley 95 VA. The worktop and lower protective base strip made of stainless steel are particularly durable and resistant to scratching. Being able to label the drawers also makes it that much easier to locate tools quickly.



1



2



3

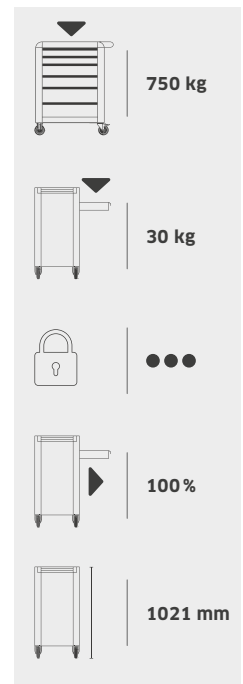

1

Wear and scratch-resistant worktop and ribbed protective base strip made of stainless steel.

2

Stainless steel handle with reinforced connection to body.

3

Drawers can be identified with several stickers per drawer (sheet of stickers included in delivery).



Professional tidiness

With capacities of approx. 9 l (AB 95) and 14 l (AB 98) respectively, these convenient containers provide ample room for waste. Optional for Models 95, 95 VA (AB 95) and 98 VA (AB 98).

The definitive version. Tool Trolley No 98VA.



If you need a larger worktop and more space for storing tools and parts, the 98 VA trolley will fit the bill. With twice the drawer capacity compared with Models 95 & 95 VA, and a much more generous worktop made of stainless steel, this model provides plenty of room. The TCS compatible drawers are particularly high-grade and can take loads of up to 40 kg each.

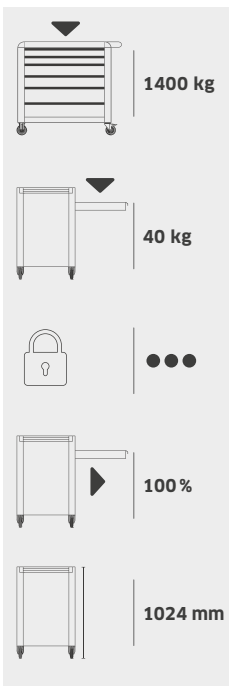

Drawer sizes

1	2	3
---	---	---

90, 95 and 95VA

1	2
3	4
5	6

98VA

- 1** In comparison with Models 90, 95 and 95 VA, this model offers 100% more drawer volume.
- 2** Drawer loads of up to 40 kg, static load capacity of 1400 kg.
- 3** All feature of Model 95 VA are included.
- 4** Five standard colour shades allow the trolleys to be individually adapted to your workshop or production needs (Models 95, 95 VA and 98 VA).



Everything within reach.

Spray-can holders SDH 95 and 98 ensure rapid access to spray cans and screwdrivers.

Model SDH 95 for 95, 95 VA: 4 spray cans, 5 screwdrivers.

Model SDH 98 for 98 VA: 6 spray-cans and 7 screwdrivers.

1

Ready for anything. Mobile Workbench WB620



STAHLWILLE's Mobile Workbench WB620 – state-of-the-art, sturdy and versatile, based on the highly successful Tool Trolley 95VA. The working height of 103 cm is ideal for professional work, the worktop is generously dimensioned and the unit is equipped with seven fully extendible drawers. The three-stage safety concept protects against unauthorised removal of tools and prevents toppling since only one drawer can be opened at any time.

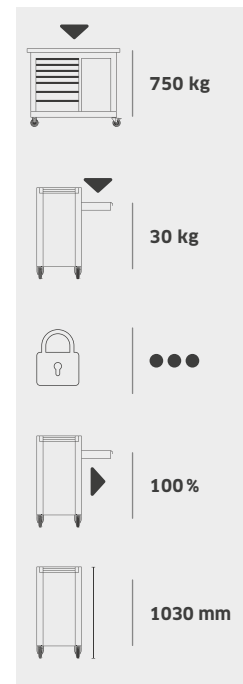

- 1 Secure** – the drawer central locking system and the lock on the cabinet section – all using the same keys – prevent unauthorised tool removal.
- 2 Ergonomic** – the worktop (115 x 50 cm) made of sturdy multiplex withstands even tough use and the working height of 103 cm is ideal for strain-free working.
- 3 Well thought-out** – seven removable drawers mounted in full extension rails with bearing cage guidance and integrated topple-proof mechanism.
- 4 Generous** – seven drawers and the spacious cabinet section provide plenty of storage space. A nice touch: the shelves in the cabinet section are adjustable in 5-cm steps. Additional shelves available on request.
- 5 High-grade** – the sturdy construction and such sophisticated features as the protective base strip made of stainless steel ensure the legendary durability STAHLWILLE is famous for. Made in Germany.
- 6 Versatile** – Perforated grid for attaching bulky tools and accessories (compatible with Tool Trolley 95). Integrated as standard: the paper-roll holder.

Tool trolleys, Tool boxes, Workbenches and accessories

90/6A Tool trolley

- 6 locking, easily removable drawers mounted in full-extension runners.
- Two-stage safety logic:
 - Central locking with a cylinder lock and fold-down key.
 - Individual locks prevent inadvertent opening in transit.
- Sturdy push-bar.
- Particularly tough, oil and Skydrol resistant worktop made of ABS with compartments for small components.
- Oil and acid resistant wheels (Ø 100 mm) with carpet protection to prevent ingress of dirt and fibres into bearings, with one parking brake.
- Can be enhanced with STAHLWILLE Standard and TCS inlays (see page 42-71).

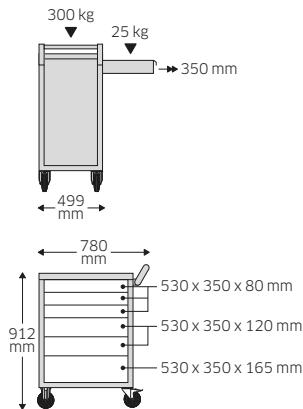

Code	Colour	Weight kg
81 20 0000	charcoal grey, RAL 7016	53.2

SCH 90 Drawers



Code	size	Dimensions mm	for No	Weight kg
81 49 00 80	80SI	530 x 350 x 80	90/6A	2.95
81 49 01 20	120SI	530 x 350 x 120	90/6A	3.55
81 49 01 65	165SI	530 x 350 x 165	90/6A	4.5

R 90 Set of wheels

Set consists of 2 fixed wheels and 2 pivoting, 100 mm Ø.
1 wheel with locking brake.



Code	for No	Weight kg
81 49 00 00	90/6A	2.75

95/6 Tool trolleys TTS

- 6 easily removable drawers mounted in full extension rails with bearing cage guidance.
- Three-stage safety logic:
 - Central locking with a cylinder lock and fold-down key.
 - Individual locks prevent inadvertent opening in transit
 - Topple-proof - it is not possible to pull out more than one drawer at a time.
- Stainless steel handle with reinforced connection to body.
- Impact protection strips with wrap-around bumper.
- Particularly tough, oil and Skydrol resistant worktop made of ABS with compartments for small components.
- Oil and acid resistant wheels (Ø 125 mm) with carpet protection to prevent ingress of dirt and fibres into bearings, with two parking brakes.
- Paper-roll holder.
- 5 Standard colour shades, drawers in two colours (silver with black full-width handle).
- Perforations from both sides for Hooks No 8031-8041, e.g. for larger tools
- Can be enhanced with STAHLWILLE Standard and TCS inlays (see pages 42-71).

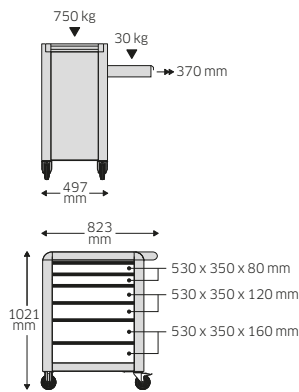

	STAHLWILLE green		RAL 2703035		RAL 9010
	RAL 3020		RAL 7016		

Code	No	Colour	Weight kg
81 20 00 10	95/6G	green	65.5
81 20 00 11	95/6R	red, RAL 3020	65.5
81 20 00 12	95/6B	blue, RAL 2703035	65.5
81 20 00 13	95/6A	charcoal grey, RAL 7016	65.5
81 20 00 14	95/6W	white, RAL 9010	65.5

SCH 95 Drawers



Code	size	Dimensions mm	for No	Weight kg
81 49 10 80	80SI	530 x 350 x 80	WB620; 95/6; 95/7; 95/8	2.8
81 49 11 20	120SI	530 x 350 x 120	WB620; 95/6; 95/7	3.05
81 49 11 60	160SI	530 x 350 x 160	WB620; 95/6; 95/7; 95/8	4.05

Factory and workshop equipment, sets of tools

1

95/7 Tool trolleys TTS

- 7 easily removable drawers mounted in full extension rails with bearing cage guidance.
- Three-stage safety logic:
 - Central locking with a cylinder lock and fold-down key.
 - Individual locks prevent inadvertent opening in transit
 - Topple-proof - it is not possible to pull out more than one drawer at a time.
- Stainless steel handle with reinforced connection to body.
- Impact protection strips with wrap-around bumper.
- Particularly tough, oil and Skydrol resistant worktop made of ABS with compartments for small components.
- Oil and acid resistant wheels (Ø 125 mm) with carpet protection to prevent ingress of dirt and fibres into bearings, with two parking brakes.
- Paper-roll holder.
- 5 Standard colour shades, drawers in two colours (silver with black full-width handle).
- Perforations from both sides for Hooks No 8031-8041, e.g. for larger tools
- Can be enhanced with STAHLWILLE Standard and TCS inlays (see pages 42-71).



- STAHLWILLE green
- RAL 2703035
- RAL 9010
- RAL 3020
- RAL 7016

Code	No	Colour	⚖ kg
81 20 00 15	95/7G	green	69,5
81 20 00 16	95/7R	red, RAL 3020	69,5
81 20 00 17	95/7B	blue, RAL 2703035	69,5
81 20 00 18	95/7A	charcoal grey, RAL 7016	69,5
81 20 00 19	95/7W	white, RAL 9010	69,5

95/8 Tool trolleys TTS

- 8 easily removable drawers mounted in full extension rails with bearing cage guidance.
- Three-stage safety logic:
 - Central locking with a cylinder lock and fold-down key.
 - Individual locks prevent inadvertent opening in transit
 - Topple-proof - it is not possible to pull out more than one drawer at a time.
- Stainless steel handle with reinforced connection to body.
- Impact protection strips with wrap-around bumper.
- Particularly tough, oil and Skydrol resistant worktop made of ABS with compartments for small components.
- Oil and acid resistant wheels (Ø 125 mm) with carpet protection to prevent ingress of dirt and fibres into bearings, with two parking brakes.
- Paper-roll holder.
- 5 Standard colour shades, drawers in two colours (silver with black full-width handle).
- Perforations from both sides for Hooks No 8031-8041, e.g. for larger tools
- Can be enhanced with STAHLWILLE Standard and TCS inlays (see pages 42-71).

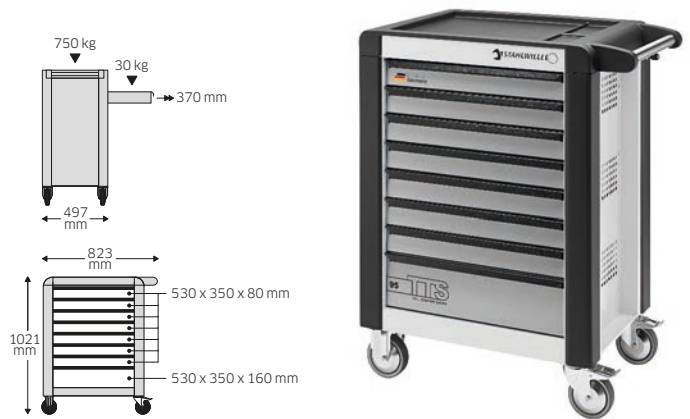

- STAHLWILLE green
- RAL 2703035
- RAL 9010
- RAL 3020
- RAL 7016

Code	No	Colour	⚖ kg
81 20 00 20	95/8G	green	74
81 20 00 21	95/8R	red, RAL 3020	74
81 20 00 22	95/8B	blue, RAL 2703035	74
81 20 00 23	95/8A	charcoal grey, RAL 7016	74
81 20 00 24	95/8W	white, RAL 9010	74

R 95 Set of wheels

Set consists of 2 fixed wheels and 2 pivoting, 125 mm Ø.
2 wheels with locking brake.



Code	for No	⚖ kg
81 49 00 01	WB620; 95; 95VA	3,9

913/4 Cover

Oil and Skydrol resistant.



Code	for No	mm	⚖ g
81 49 00 04	95	565 x 490 x 23	1250

910 Non-slip mat GRIPMAT

protects the tools,
prevents them sliding and rattling.



Code	Length mm	Width mm	⚖ g
89 01 00 03	3800	370	680

95VA/6 Tool trolleys TTS

- 6 easily removable drawers mounted in full extension rails with bearing cage guidance.
- Three-stage safety logic:
 - Central locking with a cylinder lock and fold-down key.
 - Individual locks prevent inadvertent opening in transit.
 - Topple-proof – it is not possible to pull out more than one drawer at a time.
- Drawers can be identified with multiple stickers per drawer (sheet of stickers included in delivery).
- Stainless steel handle with reinforced connection to body.
- Impact protection strips with wrap-around bumper.
- Wear and scratch-resistant worktop and ribbed protective base strip in stainless steel.
- Oil and acid resistant wheels (∅ 125 mm) with carpet protection to prevent ingress of dirt and fibres into bearings, with two parking brakes.
- Paper-roll holder.
- 5 Standard colour shades, drawers in two colours (silver with black full-width handle).
- Perforations from both sides for Hooks No 8031-8041, e.g. for larger tools.
- Can be enhanced with STAHLWILLE Standard and TCS inlays (see pages 42-71).

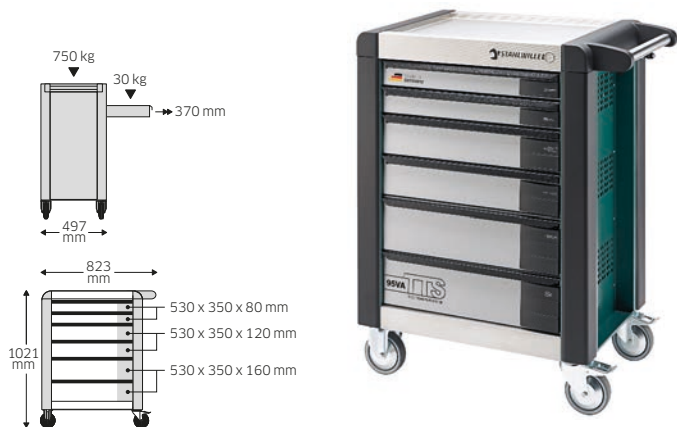

	STAHLWILLE green		RAL 2703035		RAL 9010
	RAL 3020		RAL 7016		

Code	No	Colour	∅ kg
81 20 00 55	95VA/6G	green	68.5
81 20 00 56	95VA/6R	red. RAL 3020	68.5
81 20 00 57	95VA/6B	blue. RAL 2703035	68.5
81 20 00 58	95VA/6A	charcoal grey. RAL 7016	68.5
81 20 00 59	95VA/6W	white. RAL 9010	68.5

SCH 95VA Drawers



Code	size	Dimensions mm	for No	∅ kg
81 49 30 80	80SI	530 x 350 x 80	95VA/6; 95VA/7; 95VA/8	2.9
81 49 31 20	120SI	530 x 350 x 120	95VA/6; 95VA/7	3.25
81 49 31 60	160SI	530 x 350 x 160	95VA/6; 95VA/7; 95VA/8	4.35

95VA/7 Tool trolleys TTS

- 7 easily removable drawers mounted in full extension rails with bearing cage guidance.
- Three-stage safety logic:
 - Central locking with a cylinder lock and fold-down key.
 - Individual locks prevent inadvertent opening in transit.
 - Topple-proof – it is not possible to pull out more than one drawer at a time.
- Drawers can be identified with multiple stickers per drawer (sheet of stickers included in delivery).
- Stainless steel handle with reinforced connection to body.
- Impact protection strips with wrap-around bumper.
- Wear and scratch-resistant worktop and ribbed protective base strip in stainless steel.
- Oil and acid resistant wheels (∅ 125 mm) with carpet protection to prevent ingress of dirt and fibres into bearings, with two parking brakes.
- Paper-roll holder.
- 5 Standard colour shades, drawers in two colours (silver with black full-width handle).
- Perforations from both sides for Hooks No 8031-8041, e.g. for larger tools.
- Can be enhanced with STAHLWILLE Standard and TCS inlays (see pages 42-71).

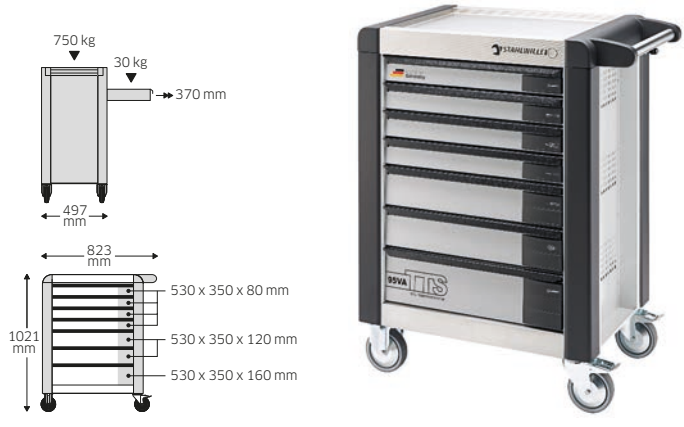

	STAHLWILLE green		RAL 2703035		RAL 9010
	RAL 3020		RAL 7016		

Code	No	Colour	∅ kg
81 20 00 60	95VA/7G	green	72.5
81 20 00 61	95VA/7R	red. RAL 3020	72.5
81 20 00 62	95VA/7B	blue. RAL 2703035	72.5
81 20 00 63	95VA/7A	charcoal grey. RAL 7016	72.5
81 20 00 64	95VA/7W	white. RAL 9010	72.5

SDH 95 Spray-can holder

for 4 spray-cans and 5 screwdrivers.



Code	for No	∅ kg
81 49 00 03	WB620; 95; 95VA	1.5

Factory and workshop equipment, sets of tools

1

95VA/8 Tool trolleys TTS

- 8 easily removable drawers mounted in full extension rails with bearing cage guidance.
- Three-stage safety logic:
 - Central locking with a cylinder lock and fold-down key.
 - Individual locks prevent inadvertent opening in transit.
 - Topple-proof – it is not possible to pull out more than one drawer at a time.
- Drawers can be identified with multiple stickers per drawer (sheet of stickers included in delivery).
- Stainless steel handle with reinforced connection to body.
- Impact protection strips with wrap-around bumper.
- Wear and scratch-resistant worktop and ribbed protective base strip in stainless steel.
- Oil and acid resistant wheels (∅ 125 mm) with carpet protection to prevent ingress of dirt and fibres into bearings, with two parking brakes.
- Paper-roll holder.
- 5 Standard colour shades, drawers in two colours (silver with black full-width handle).
- Perforations from both sides for Hooks No 8031-8041, e.g. for larger tools.
- Can be enhanced with STAHLWILLE Standard and TCS inlays (see pages 42-71).

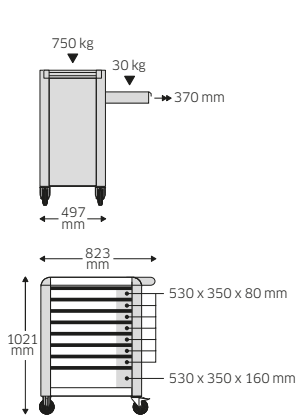

- STAHlwILLE green
- RAL 2703035
- RAL 9010
- RAL 3020
- RAL 7016

Code	No	Colour	∅ kg
81 20 00 65	95VA/8G	green	77
81 20 00 66	95VA/8R	red, RAL 3020	77
81 20 00 67	95VA/8B	blue, RAL 2703035	77
81 20 00 68	95VA/8A	charcoal grey, RAL 7016	77
81 20 00 69	95VA/8W	white, RAL 9010	77

98VA/6 Tool trolleys TTS

- In comparison with the 90, 95 and 95VA models, this model offers 100% more drawer volume.**
- 6 easily removable drawers mounted in full extension rails with bearing cage guidance.
- Three-stage safety logic:
 - Central locking with a cylinder lock and fold-down key.
 - Individual locks prevent inadvertent opening in transit.
 - Topple-proof – it is not possible to pull out more than one drawer at a time.
- Drawers can be identified with multiple stickers per drawer (sheet of stickers included in delivery).
- Stainless steel handle with reinforced connection to body.
- Impact protection strips with wrap-around bumper.
- Wear and scratch-resistant worktop and ribbed protective base strip in stainless steel.
- Oil and acid resistant ball-bearing mounted low-friction wheels (∅ 125 mm) with carpet protection to prevent ingress of dirt and fibres into bearings, with two parking brakes.
- Paper-roll holder.
- 5 Standard colour shades, drawers in two colours (silver with black full-width handle).
- Perforations from both sides for Hooks No 8031-8041, e.g. for larger tools.
- Can be enhanced with STAHLWILLE Standard and TCS inlays (see pages 42-71).

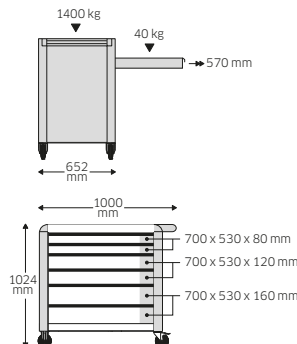

- STAHlwILLE green
- RAL 2703035
- RAL 9010
- RAL 3020
- RAL 7016

Code	No	Colour	∅ kg
81 20 00 99	98VA/6G	green	98
81 20 01 00	98VA/6R	red, RAL 3020	98
81 20 01 01	98VA/6B	blue, RAL 2703035	98
81 20 01 02	98VA/6A	charcoal grey, RAL 7016	98
81 20 01 03	98VA/6W	white, RAL 9010	98

AB 95 Rubbish bin

Capacity approx. 9 l.



Code	for No	mm	∅ kg
89 01 00 52	WB620; 95, 95VA	302 x 133 x 320	2.1

SCH 98VA Drawers



Code	size	Dimensions mm	for No	∅ kg
81 49 20 80	80SI	700 x 530 x 80	98VA/6; 98VA/7; 98VA/8	5.0
81 49 21 20	120SI	700 x 530 x 120	98VA/6; 98VA/7	6.0
81 49 21 60	160SI	700 x 530 x 160	98VA/6; 98VA/7; 98VA/8	6.5

98VA/7 Tool trolleys TTS

- In comparison with the 90, 95 and 95VA models, this model offers **100% more drawer volume**.
- 7 easily removable drawers mounted in full extension rails with bearing cage guidance.
- Three-stage safety logic:
 - Central locking with a cylinder lock and fold-down key.
 - Individual locks prevent inadvertent opening in transit.
 - Topple-proof – it is not possible to pull out more than one drawer at a time.
- Drawers can be identified with multiple stickers per drawer (sheet of stickers included in delivery).
- Stainless steel handle with reinforced connection to body.
- Impact protection strips with wrap-around bumper.
- Wear and scratch-resistant worktop and ribbed protective base strip in stainless steel.
- Oil and acid resistant ball-bearing mounted low-friction wheels (Ø 125 mm) with carpet protection to prevent ingress of dirt and fibres into bearings, with two parking brakes.
- Paper-roll holder.
- 5 Standard colour shades, drawers in two colours (silver with black full-width handle).
- Perforations from both sides for Hooks No 8031-8041, e.g. for larger tools.
- Can be enhanced with STAHLWILLE Standard and TCS inlays (see pages 42-71).

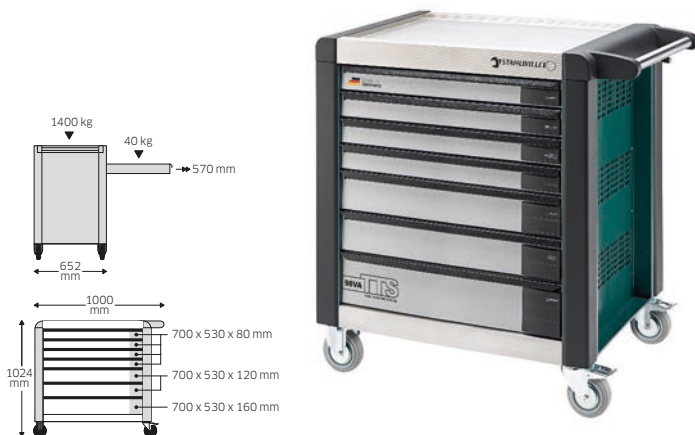

- STAHLWILLE green
- RAL 3020
- RAL 2703035
- RAL 7016
- RAL 9010

Code	No	Colour	Δ kg
81 20 01 04	98VA/7G	green	100
81 20 01 05	98VA/7R	red, RAL 3020	100
81 20 01 06	98VA/7B	blue, RAL 2703035	100
81 20 01 07	98VA/7A	charcoal grey, RAL 7016	100
81 20 01 08	98VA/7W	white, RAL 9010	100

98VA/8 Tool trolleys TTS

- In comparison with the 90, 95 and 95VA models, this model offers **100% more drawer volume**.
- 8 easily removable drawers mounted in full extension rails with bearing cage guidance.
- Three-stage safety logic:
 - Central locking with a cylinder lock and fold-down key.
 - Individual locks prevent inadvertent opening in transit.
 - Topple-proof – it is not possible to pull out more than one drawer at a time.
- Drawers can be identified with multiple stickers per drawer (sheet of stickers included in delivery).
- Stainless steel handle with reinforced connection to body.
- Impact protection strips with wrap-around bumper.
- Wear and scratch-resistant worktop and ribbed protective base strip in stainless steel.
- Oil and acid resistant ball-bearing mounted low-friction wheels (Ø 125 mm) with carpet protection to prevent ingress of dirt and fibres into bearings, with two parking brakes.
- Paper-roll holder.
- 5 Standard colour shades, drawers in two colours (silver with black full-width handle).
- Perforations from both sides for Hooks No 8031-8041, e.g. for larger tools.
- Can be enhanced with STAHLWILLE Standard and TCS inlays (see pages 42-71).

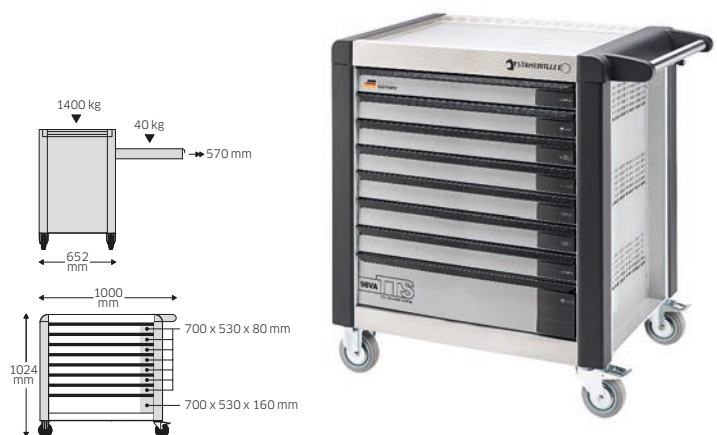

- STAHLWILLE green
- RAL 3020
- RAL 2703035
- RAL 7016
- RAL 9010

Code	No	Colour	Δ kg
81 20 01 09	98VA/8G	green	102
81 20 01 10	98VA/8R	red, RAL 3020	102
81 20 01 11	98VA/8B	blue, RAL 2703035	102
81 20 01 12	98VA/8A	charcoal grey, RAL 7016	102
81 20 01 13	98VA/8W	white, RAL 9010	102

R 98 Set of wheels

Set consists of 2 fixed and 2 pivoting ball-bearing mounted low-friction wheels, 125 mm Ø. 2 wheels with locking brake.



Code	for No	Δ kg
81 49 00 05	WB620, 95, 95VA, 98VA	4.2

AB 98 Rubbish bin

Capacity approx. 14 l.



Code	for No	mm	Δ kg
89 01 00 53	98VA	456 x 150 x 370	3

Factory and workshop equipment, sets of tools

1

R 95/98S Set of wheels

NEW

consists of:
4 ball-bearing mounted,
smooth-running swivelling castors
(\varnothing 125 mm),
2 with parking brakes,
2 with directional locks.



Code	for No	Δ kg
89 48 00 03	WB620; 95; 95VA; 98VA	5

SDH 98 Spray-can holder

for 6 spray-cans and 7 screwdrivers.



Code	for No	Δ kg
89 01 00 49	98VA	1.9

912 Empty tray for small components

with compartments for small parts
such as screws, nuts etc.
Oil and Skydrol resistant.
8 compartments each 60 x 80 mm or
80 x 80 mm,
2 compartments each 100 x 165 mm or
50 x 330 mm.



Code	for No	mm	Δ g
83 81 20 70	WB620; 95; 95VA; 98; 920; 922N	520 x 340 x 30	330

VE 50-150 Drawer separators

allow you to divide up the drawer
the way you need it.
Consisting of: one each galvanised
steel front and back piece and three
separators.



Code	for No	mm	Δ kg
81 48 40 01	WB620; 90/6A; 95; 95VA; 98VA; 920; 922N	530 x 350 x 40	0.8

KH 91 Cable holder

for storing cable and hoses.



Code	for No	mm	Δ kg
89 01 00 40	WB620; 95; 95VA; 98VA	200 x 153 x 170	0.86

913/95, 913/98 Multiplex beechwood worktop

NEW



Code	No	for No	mm	Δ kg
89 01 00 31	913/95	95VA	563 x 415 x 15	2.8
89 01 00 32	913/98	98VA	741 x 570 x 15	4.8

WB620 Mobile workbench

NEW

- 7 easily removable drawers mounted in full extension rails with bearing cage guidance.
- Three-stage safety logic:
 - Central locking with a cylinder lock and fold-down key.
 - Individual locks prevent inadvertent opening in transit.
 - Toppo-proof - it is not possible to pull out more than one drawer at a time.
- Large worktop with multiplex beechwood worktop, 1150 x 500 mm.
- Ribbed protective base strip made of stainless steel.
- Oil and acid resistant wheels (\varnothing 125 mm) with carpet protection to prevent ingress of dirt and fibres into bearings, with two parking brakes.
- Roomy storage area with an adjustable shelf in the cabinet
- Paper-roll holder.
- Perforations from both sides for Hooks No 8031-8041, e.g. for larger tools.
- Can be combined with accessories range for Tool Trolley 95.
- Can be enhanced with STAHLWILLE Standard and TCS inlays (see pages 42-71).

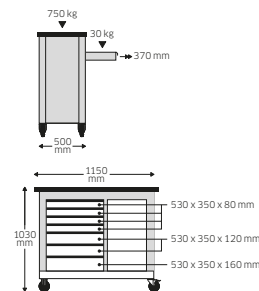

Code	Colour	Δ kg
85 01 06 20	charcoal grey, RAL 7016	87.0

WB620 FB Compartment shelf

NEW

Additional shelf for Mobile
Workbench WB620



Code	Colour	mm	Δ kg
85 11 06 20	silver, RAL 9006	452 x 394 x 8	1.36

96/3 Mobile workbench

with chassis and retractable tool panel. 5 ball-bearing mounted steel drawers with slotted liners for partitioning drawers. Aluminium handle. Automatic catches on all drawers prevent them opening in transit. Lockup cabinet with height-adjustable shelf. Worktop is 50 mm thick, warp- and water resistant, multilayer bonded beech wood with clear varnish finish. Front edge has hardwood edging strip.

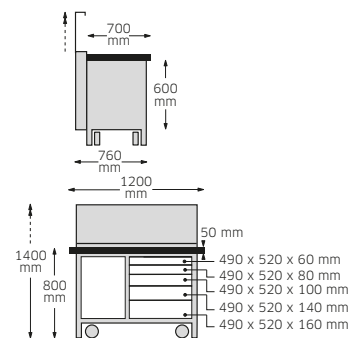

Code	Δ kg
85 03 00 03	166.5

920 Magazine case

with 5 drawers and 5 magazines. **Converts to tool trolley with undercarriage No R 920.** Features two removable spray can holders on the end pieces of the case and two integrated lifting handles. Drawers for mounting magazines are removable and lockable in fully extended position. The magazines can be replaced with standard drawers. The worktop of the case is fitted with an oil and Skydrol resistant plastic mat with compartments for small components.

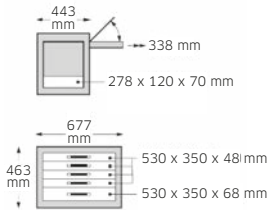

Code	Colour	Can be combined with No	⊘ kg
81 48 00 00	red RAL 3020	920; 922N	53.6

922N Wheely box with drawers

With 4 wheels \varnothing 125 mm (2 pivoting castors, one wheel with parking brake). With 5 silver-coloured drawers (sizes: 4 drawers 60 mm high, 1 x 80 mm). Drawers are removable and lockable in fully extended position. The worktop of the case is fitted with an oil and Skydrol resistant plastic mat with compartments for small components. Spray can holders No SDH 921 can be retrofitted to the sides (please order separately).

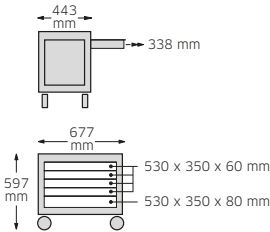

Code	Colour	Can be combined with No	⊘ kg
96 48 00 02	red RAL 3020	920	39.5

Accessories CONVERTA

SCH 60-80 Drawers

coated with environmentally friendly silver-coloured textured powder-coat.



Code	No	Dimensions mm	Can be combined with No	⊘ kg
81 48 20 60	SCH 60	530 x 350 x 60	922N	2.4
81 48 20 80	SCH 80	530 x 350 x 80	920; 922N	2.8

913 Cover

Oil and Skydrol resistant.



Code	for No	mm	⊘ g
89 01 00 11	920; 922N	680 x 450 x 20	936

920 C-SCH Magazine drawer

Coated with environmentally friendly silver-coloured textured powder-coat. For mounting tool magazines No 920 C.



Code	⊘ kg
81 48 10 00	2.64

920 C Tool magazines

Coated with environmentally friendly silver-coloured textured powder-coat. For use with magazine drawers No 920 C-SCH



Code	No	Dimensions mm	Can be combined with No	⊘ kg
81 48 10 60	920 C 60	530 x 350 x 48	920; 922N	3.2
81 48 10 80	920 C 80	530 x 350 x 68	920; 922N	3.3

R 920 Set of wheels

Set consists of 2 fixed wheels and 2 pivoting, 125 mm \varnothing . 2 wheels with locking brake.



Code	for No	⊘ kg
89 48 00 01	920; 922N	4.3

SDH 921 Spray can and paper roll holder













coated with environmentally friendly silver-coloured textured powder-coat.

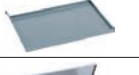
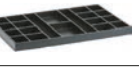

Code	for No	⊘ kg
81 48 30 01	920; 922N	0.35

Accessories Tool Trolley, Tool Box and Mobile Workbench

1

	No 90/6A	No 95/6	No 95/7	No 95/8	No 95VA/6	No 95VA/7	No 95VA/8	No 98VA/6	No 98VA/7	No 98VA/8	No 920	No 922N	No WB620
Drawers													
	SCH 90-80SI	•											
	SCH 90-120SI	•											
	SCH 90-165SI	•											
	SCH 95-80SI		•	•									•
	SCH 95-120SI		•	•									•
	SCH 95-160SI		•	•									•
	SCH 95VA-80SI				•	•	•						
	SCH 95VA-120SI				•	•							
	SCH 95VA-160SI				•	•	•						
	SCH 98VA-80SI							•	•	•			
	SCH 98VA-120SI							•	•	•			
	SCH 98VA-160SI							•	•	•			
	SCH 60										•	•	
	SCH 80										•	•	
Drawers separators													
	VE 50-150	•	•	•	•	•	•	•	•	•	•	•	•
Magazine drawer													
	920C-SCH										•	•	
Tool magazines													
	920 C 60										•	•	
	920 C 80										•	•	
	920 C 120												
Empty tray for small components													
	912		•	•	•	•	•	•	•	•	•	•	•
Worktops													
	913										•	•	
	913/4		•	•	•								
Wooden worktops													
	913/95				•	•	•						
	913/98							•	•	•			
Cable holder													
	KH 91		•	•	•	•	•	•	•	•			•
Spray can holders													
	SDH 95		•	•	•	•	•						•
	SDH 98							•	•	•			
	SDH 921										•	•	
Rubbish bins													
	AB 95		•	•	•	•	•						•
	AB 98							•	•	•			
Sets of wheels													
	R90	•											
	R95		•	•	•	•	•						•
	R98		•	•	•	•	•	•	•	•			•
	R95/98S		•	•	•	•	•	•	•	•			•
	R920										•	•	

Tool boxes

13217 Tool trolleys

- Extremely sturdy, tool trolley resilient to loads and made of polypropylene for professional use.
- 5 easily removed lockable drawers with transparent covers, with endstops for the extendible rails, 3 different drawer heights.
- Drawers can be inserted in any order.
- With one top cover and one front cover, both folding.
- The top cover is fitted with napped foam to hold tools firmly in place.
- One removable tray with 2 handles and 2 transparent drawer covers under the top cover.
- Drawers can be used as separate tool boxes using the transparent cover.
- Tool case and drawers can be individually marked.
- 2 smooth-running twin castors on the telescopic-handle side
- Adaptable for vertical transport using 4 castors, R 13217 Set of castors (please order separately).
- Extendible telescopic handle facilitates transport.
- 2 carrying handles at the sides.
- Resistant to Skydrol, acetone, petrol and hydraulic fluids.
- Carrying capacity 60 kg.
- 3 locking positions with padlock.
- Also available as IP67 version (6 drawers, 4 x 30 mm, 2 x 60 mm). Additional catches and seals protect against water and dust. Special valve for pressure relief.**
- Also available with all-round high-visibility reflecting surface (5 drawers, 2 x 30 mm, 3 x 60 mm), for increased safety when working in dark surroundings.**
- Individually tailored trolleys are available on request**



13217 TS IP67



13217 TS RF



Delivery without tools

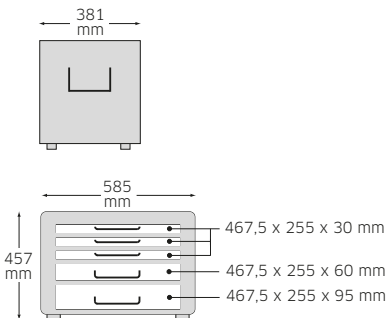

luminous yellow

luminous red

jet black

Code	No	Colour	⚖️ kg
8109 1301	13217 LGE	luminous yellow	15
8109 1304	13217 LR	luminous red	15
8109 1306	13217 TS	jet black	15
8109 1322	13217 TS IP67 NEW	jet black	15
96 89 48 09	13217 TS RF NEW	jet black (with reflecting film)	15

Factory and workshop equipment, sets of tools

805/4 WT TCS Tool set for Tool Trolley No 13217



89 Tools, in TCS inlays (Tool Control System see page 53).
Additional sets of tools with Tool Trolley No 13217 on pages 34, 37, 39, 40.

Code	⚖️ kg
97 84 28 03	9.2

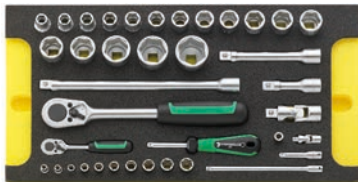

96 83 43 15



96 83 43 16



96 83 43 17



96 83 43 18

	No 13	sizes 6; 7; 8; 10; 11; 12; 13; 14; 15; 16; 17; 18; 19; 22; 24 mm
	No 17	sizes 8; 10; 13; 17; 19 mm
	No 40	1/4" ⚫ sizes 5; 5.5; 6; 7; 8; 9; 10; 11; 12; 13 mm
	No 400	1/4" ■ 150 mm
	No 405/2	1/4" ■ ⚫ 54 mm
	No 405/6	1/4" ■ ⚫ 150 mm
	No 407	1/4" ■ ⚫ 38 mm
	No 412	1/4" ○ ○
	No 415	1/4" ■
	No 52	1/2" ○ sizes 10; 11; 12; 13; 14; 15; 16; 17; 18; 19; 20; 21; 22; 24; 27; 30; 32 mm
	No 509/3	1/2" ■ ⚫ 75 mm
	No 509/5	1/2" ■ ⚫ 130 mm
	No 509/10	1/2" ■ ⚫ 255 mm
	No 510	1/2" ■ ⚫ 71 mm
	No 512	1/2" ■
	No 4620	size 1 (0.6 x 3.5 x 75 mm) size 2 (0.8 x 4.0 x 100 mm) size 3 (1.0 x 5.5 x 125 mm) size 4 (1.2 x 6.5 x 150 mm) size 5 (1.6 x 8.0 x 175 mm)
	No 4628	size 1 (0.4 x 2.5 x 60 mm)
	No 4630	sizes 1; 2; 3
	No 4734	size 2
	No 10767/9	sizes 1.5; 2; 2.5; 3; 4; 5; 6; 8; 10 mm
	No 10771/8	sizes T9; T10; T15; T20; T25; T27; T30; T40

No 65 01 5 180

No 65 29 5 200

No 65 51 6 240

No 66 02 5 160

R 13217 Set of wheels

optional extra castors allowing upright travel on four wheels, consists of: 4 swivelling castors, 2 of which with parking brakes.



Code	for No	⚖️ kg
96 89 48 05	13217	0.63

13217 TA Transparent cover

The cover is fitted to the top lid and provides additional storage space, e.g. for documents. Delivery includes fixing materials.



Code	for No	⚖️ kg
89 01 01 00	13217	0.63

TR-SCH Drawers

for Tool Trolley No 13217, black



Code	size	Dimensions mm	⚖️ kg
81 48 32 30	30 SC	467.5 x 255 x 30	0.56
81 48 32 60	60 SC	467.5 x 255 x 60	0.78
81 48 32 95	95 SC	467.5 x 255 x 95	0.9



806/6 WT TCS Tool set for Tool Trolley No 13217



104 Tools, in TCS inlays (Tool Control System see page 53).
Additional sets of tools with Tool Trolley No 13217 on pages 34, 37, 39, 40.

Code	kg
97 83 02 07	14.2



96 83 00 94



96 83 00 95



96 83 00 96



96 83 00 97



96 83 00 98



96 83 00 99

No 10	sizes 6 x 7; 8 x 9; 10 x 11; 12 x 13; 14 x 15; 16 x 17; 18 x 19; 20 x 22; 24 x 27; 30 x 32 mm
No 13	sizes 6; 7; 8; 9; 10; 11; 12; 13; 14; 15; 16; 17; 18; 19; 20; 21; 22; 24 mm
No 17	sizes 8; 10; 13; 17; 19 mm
No 40	1/4" sizes 5.5; 6; 7; 8; 9; 10; 11; 12; 13; 14 mm
No 400	1/4" 150 mm
No 404	1/4" 116 mm
No 405/2	1/4" 54 mm
No 405/6	1/4" 150 mm
No 407	1/4" 38 mm
No 412	1/4"
No 415	1/4"
No 10760CV	sizes 1.5; 2; 2.5; 3; 4; 5; 6; 8; 10; 12 mm
No 52	1/2" sizes 10; 11; 12; 13; 14; 15; 16; 17; 18; 19; 20; 21; 22; 24; 27; 30; 32 mm
No 506	1/2" 300 mm
No 509/2	1/2" 52 mm

No 509/5	1/2" 130 mm
No 509/10	1/2" 255 mm
No 510	1/2" 71 mm
No 512	1/2"
No 4620	size 1 (0.6 x 3.5 x 75 mm) size 2 (0.8 x 4.0 x 100 mm) size 3 (1.0 x 5.5 x 125 mm) size 4 (1.2 x 6.5 x 150 mm) size 5 (1.6 x 8.0 x 175 mm)
No 4630	sizes 1; 2; 3
No 65 01 5 180	
No 65 29 5 200	
No 65 43 4 002	
No 65 45 4 002	
No 65 51 6 240	
No 65 64 2 250	
No 66 02 5 160	
No 102	175 mm
No 108	150 x 6; 175 x 6 mm
No 109	size 6; 100 x 3.4 mm
No 10956	∅ 35 mm
No 10960	500 g

TCS inlays for Tool Trolley No 13217

TCS WT 10/10, 6-32 mm



for the drawers of Tool Trolley No 13217, 460 x 250 x 30 mm, 10 pieces



Code	g
96 83 01 20	1550

No 10	sizes 6 x 7; 8 x 9; 10 x 11; 12 x 13; 14 x 15; 16 x 17; 18 x 21; 20 x 22; 24 x 27; 30 x 32 mm
--------------	---

TCS WT 10a/9



for the drawers of Tool Trolley No 13217, 460 x 250 x 30 mm, 9 pieces



Code	g
96 83 01 24	1600

No 10a	sizes 1/4 x 5/16; 3/8 x 7/16; 1/2 x 9/16; 19/32 x 11/16; 5/8 x 3/4; 3/4 x 7/8; 25/32 x 13/16; 15/16 x 1; 1 1/8 x 1 5/16"
---------------	--

Factory and workshop equipment, sets of tools

1

TCS WT 13/18, 6-24 mm



for the drawers of Tool Trolley No 13217, 460 x 250 x 60 mm, 18 pieces

Code	g
96830121	1880
No 13	sizes 6; 7; 8; 9; 10; 11; 12; 13; 14; 15; 16; 17; 18; 19; 20; 21; 22; 24 mm

TCS WT 13a/22



for the drawers of Tool Trolley No 13217, 460 x 250 x 60 mm, 22 pieces

Code	g
96830125	2440
No 13a	sizes 3/16; 13/64; 7/32; 15/64; 1/4; 9/32; 5/16; 11/32; 3/8; 7/16; 1/2; 9/16; 19/32; 5/8; 11/16; 3/4; 25/32; 13/16; 7/8; 15/16; 1; 1 1/16"

TCS WT 17/12



for the drawers of Tool Trolley No 13217, 460 x 250 x 30 mm, 12 pieces

Code	g
96830128	1490
No 17	sizes 8; 9; 10; 11; 12; 13; 14; 15; 16; 17; 18; 19 mm

TCS WT 240/10



for the drawers of Tool Trolley No 13217, 460 x 250 x 30 mm, 10 pieces

Code	g
96830130	2005
No 240	sizes 8; 10; 11; 12; 13; 14; 16; 17; 18; 19 mm

TCS WT 40/4008/10/9



for the removable tray of Tool Trolley No 13217, cannot be combined with transparent cover 13217 TA, 460 x 250 x 30 mm, 39 pieces

Code	g
96830132	1120
No 40	1/4" sizes 4; 4.5; 5; 6; 7; 8; 10; 11; 12; 13 mm
No 405QR/2	1/4" 54 mm
No 405QR/6	1/4" 150 mm
No 407QR	1/4" 38 mm
No 412	1/4"
No 415QR N	1/4"
No 1204/21-1	4 x ; 4 x ; 9 x ; 3 x
No 3115/1	1/4"
No 4008	sizes 1; 2

TCS WT 40/45/46/37/14

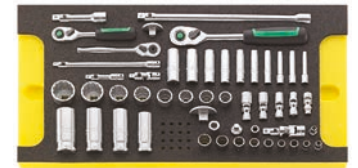

for the removable tray of Tool Trolley No 13217, cannot be combined with transparent cover 13217 TA, 455 x 240 x 30 mm, 51 pieces

Code	g
96830123	2500
No 40aD	1/4" sizes 3/16; 7/32; 1/4; 9/32; 5/16; 11/32; 3/8; 7/16; 1/2; 9/16"
No 402a	1/4" sizes 1/4; 5/16; 3/8; 7/16; 1/2"
No 40aDL	3/8" sizes 3/16; 7/32; 1/4; 9/32; 5/16; 11/32; 3/8; 7/16; 1/2; 9/16"
No 45a	3/8" sizes 1/2; 9/16; 19/32; 5/8; 11/16; 3/4; 15/16; 1"
No 46a	3/8" sizes 5/8; 11/16; 3/4; 7/8"
No 405QR/2	1/4" 54 mm
No 405QR/6	1/4" 150 mm
No 407QR	1/4" 38 mm
No 409M	3/8" 1/4"
No 415QR N	1/4"
No 415SGB N	1/4"
No 412	1/4"
No 427QR/3	3/8" 76 mm
No 427QR/10	3/8" 240 mm
No 428QR	3/8" 46 mm
No 431	1/4" 3/8"
No 432M	1/2" 3/8"
No 435QR N	3/8"
No 443	5/16" 3/8"

TCS WT 40/52/27/13



for the removable tray of Tool Trolley No 13217, cannot be combined with transparent cover 13217 TA, 455 x 240 x 30 mm, 40 pieces



Code		Δ	g
96 83 01 17			4000
No 40	1/4" ○ sizes 5.5; 6; 7; 8; 9; 10; 11; 12; 13; 14 mm		
No 52	1/2" ○ sizes 10; 11; 12; 13; 14; 15; 16; 17; 18; 19; 20; 21; 22; 24; 27; 30; 32 mm		
No 400	1/4" ■ 150 mm		
No 404	1/4" ■ 116 mm		
No 405/2	1/4" ■ ○ 54 mm		
No 405/6	1/4" ■ ○ 150 mm		
No 407	1/4" ■ ○ 38 mm		
No 412	1/4" ○ ○		
No 415QR N	1/4" ■		
No 506	1/2" ■ 300 mm		
No 509/2	1/2" ■ 52 mm		
No 509/5	1/2" ■ ○ 130 mm		
No 509/10	1/2" ■ ○ 255 mm		
No 510	1/2" ■ ○ 71 mm		
No 512QR N	1/2" ■		

TCS WT 4622-4650



for the drawers of Tool Trolley No 13217, 460 x 250 x 60 mm, 20 pieces



Code		Δ	g
96 83 01 22			1500
No 4622SK	size 1 (0.8 x 4.0 x 90 mm) size 2 (1.0 x 5.5 x 100 mm) size 3 (1.2 x 6.5 x 125 mm)		
No 4632SK	sizes 1; 2; 3		
No 4650	sizes T10; T15; T20; T25; T30		
No 10767H/9	sizes 1.5; 2; 2.5; 3; 4; 5; 6; 8; 10 mm		

TCS WT 4622-4650-1



for the drawers of Tool Trolley No 13217, 460 x 250 x 60 mm, 24 pieces



Code		Δ	g
96 83 01 26			1610
No 4622SK	size 1 (0.8 x 4.0 x 90 mm) size 2 (1.0 x 5.5 x 100 mm) size 3 (1.2 x 6.5 x 125 mm)		
No 4632SK	sizes 1; 2; 3		
No 4650	sizes T10; T15; T20; T25; T30		
No 10767a/13	sizes 0.050; 1/16; 5/64; 3/32; 7/64; 1/8; 9/64; 5/32; 3/16; 7/32; 1/4; 5/16; 3/8"		

TCS WT 4650-4665-1



for the drawers of Tool Trolley No 13217, 460 x 250 x 60 mm, 20 pieces



Code		Δ	g
96 83 01 29			1320
No 4650	sizes T10; T15; T20; T25; T30		
No 4660 VDE	size 1 (0.4 x 2.5 x 75 mm) size 3 (0.6 x 3.5 x 100 mm) size 5 (1.0 x 5.5 x 125 mm)		
No 4665 VDE	sizes 1; 2; 3		
No 10767H/9	sizes 1.5; 2; 2.5; 3; 4; 5; 6; 8; 10 mm		

TCS WT 4650-4665



for the drawers of Tool Trolley No 13217, 460 x 250 x 60 mm, 24 pieces



Code		Δ	g
96 83 01 27			1400
No 4650	sizes T10; T15; T20; T25; T30		
No 4660 VDE	size 1 (0.4 x 2.5 x 75 mm) size 3 (0.6 x 3.5 x 100 mm) size 5 (1.0 x 5.5 x 125 mm)		
No 4665 VDE	sizes 1; 2; 3		
No 10767a/13	sizes 0.050; 1/16; 5/64; 3/32; 7/64; 1/8; 9/64; 5/32; 3/16; 7/32; 1/4; 5/16; 3/8"		

Factory and workshop equipment, sets of tools

1

TCS WT 6501-6602/7



for the drawers of Tool Trolley
No 13217, 460 x 250 x 30 mm,
7 pieces

Code		♻️ g
96830118		1880
No 65 01 5 180		
No 65 29 5 200		
No 65 43 4 002		
No 65 45 4 002		
No 65 51 6 240		
No 65 64 2 250		
No 66 02 5 160		

TCS WT 6501-6602/7-1



for the drawers of Tool Trolley
No 13217, 460 x 250 x 30 mm,
7 pieces

Code		♻️ g
96830131		1660
No 65 01 5 180		
No 65 29 5 200		
No 65 43 4 002		
No 65 45 4 002		
No 65 51 6 240		
No 65 75 1 220		
No 66 02 5 160		

TCS WT 102-109/16



for the drawers of Tool Trolley
No 13217, 460 x 250 x 30 mm,
16 pieces

Code		♻️ g
96830119		1790
No 102	175 mm	
No 105	120 x 12 mm	
No 108	115 x 2; 150 x 3; 150 x 4; 150 x 5; 150 x 6; 150 x 8 mm	
No 109	size 6; 100 x 3.4 mm	
No 10956	∅ 27 mm	
No 10960	300 g	
No 12320		
No 12921M	∅ 32 mm	
No 12935/3	3 m	
No 13110	300 mm	
No 13126-2		

Tool Control System The safety inlay system

- Designed to fit our Tool Trolleys and Tool Boxes
- With yellow signal cut-outs to show whether all tools are in their places

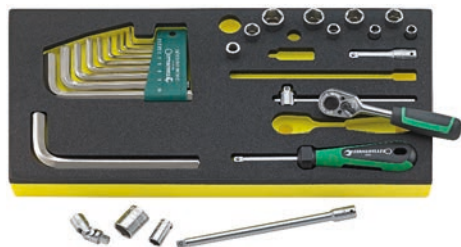

13216/2 Tool box

with 2 drawers and one compartment under the lid, safety lock and dip-coated carrying handle on the lid. Wide, spring-mounted dip-coated carrying handles on the sides. High-grade, fully extendible sturdy rails. Easily removable drawers. The perforated panel can be arranged as required using spring loaded clips No 8050 (page 24, please order separately).



Code	⚖️ kg
81091002	10.3

13216/3 Tool box

with 3 drawers and one compartment under the lid, safety lock and dip-coated carrying handle on the lid. Wide, spring-mounted dip-coated carrying handles on the sides. High-grade, fully extendible sturdy rails. Easily removable drawers. The perforated panel can be arranged as required using spring loaded clips No 8050 (page 24, please order separately).



Code	⚖️ kg
81091003	11

83/010 Tool box, 3 trays

lockable by padlock.



Code	Width mm	Height mm	Depth mm	⚖️ kg
81060000	420	150	200	3.7

82/013 Tool box

with lift out tray. Lockable by padlock.



Code	Width mm	Height mm	Depth mm	⚖️ kg
81080000	545	225	180	6.9

13216/4 Tool box

with 4 drawers, a compartment under the lid, safety lock and sturdy textured aluminium sheeting on the lid. Wide, spring-mounted dip-coated carrying handles on the sides. High-grade, fully extendible sturdy rails. Easily removable drawers. The perforated panel can be arranged as required using spring loaded clips No 8050 (page 24, please order separately).

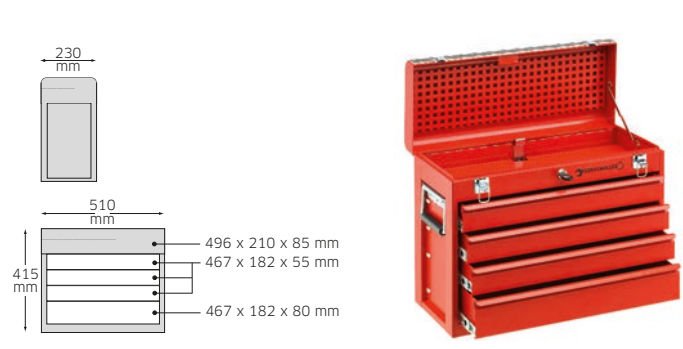

Code	⚖️ kg
81091004	14

TBT13216 Tool box trolley

- for tool boxes No 13216/2, 13216/3, 13216/4.
 - Safe tool box locking system with quick-release mechanism.
 - Unrestricted access to all tool box functions.
 - Sturdy steel-sheet construction.
 - 2 fixed wheels and 2 castors (∅ 75 mm) with parking brakes.
 - Convenient, fold-away push-handle with endstop.
 - Maximum static load capacity: 150 kg
- Supplied without tool box.



Code	Width mm	Height mm	Depth mm	⚖️ kg
81091009	570	216 (914 open)	328	7.5

83/09 Tool box, 5 trays

lockable by padlock.



Code	Width mm	Height mm	Depth mm	⚖️ kg
81050000	420	200	200	4.7

446/08 Tool box, 5 trays

lockable by padlock.



Code	Width mm	Height mm	Depth mm	⚖️ kg
81070000	530	200	200	5.59

Perforated panels, hooks and holding devices

8002 Perforated panel

Perforation 9 x 9 mm, made of sturdy, 1 mm thick sheet steel, with 2 strengthening ribs at rear. These ribs carry the holes for wall mounting panel.

For the individual mounting of tools, on a variety of hooks and clips No 8031-8041.

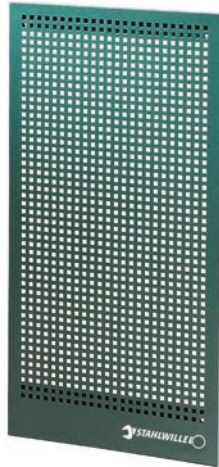

Code	Width mm	Height mm	Depth mm	△△ kg
80020001	500	1000	15	4

8031 Single hook

for perforated panel No 8002, Mobile workbench No WB620 and Tool trolleys No 95, 95VA, 98VA.



Code	size	mm	△△ g	△ kg
80310030	1	30	13	5
80310060	2	60	17	5
80310090	3	90	21	5

8032 Twin hook

for perforated panel No 8002, Mobile workbench No WB620 and Tool trolleys No 95, 95VA, 98VA.



Code	size	mm	△△ g	△ kg
80320030	1	30	19	3
80320060	2	60	26	3

8034 Twin hook

for perforated panel No 8002, Mobile workbench No WB620 and Tool trolleys No 95, 95VA, 98VA.



Code	size	mm	△△ g	△ kg
80340040	1	40 x 35	30	3
80340050	2	50 x 40	30	3

8035 Square lug

for perforated panel No 8002, Mobile workbench No WB620 and Tool trolleys No 95, 95VA, 98VA.



Code	size	mm	△△ g	△ kg
80350017	1	17 x 35	23	3
80350020	2	20 x 55	26	3

8036 Spring clip

for perforated panel No 8002, Mobile workbench No WB620 and Tool trolleys No 95, 95VA, 98VA.



Code	size	mm	△△ g	△ kg
80360012	1	12	9	6
80360018	2	18	10	6
80360024	3	24	14	6

8038 Container

for perforated panel No 8002, Mobile workbench No WB620 and Tool trolleys No 95, 95VA, 98VA.



Code	mm	△△ g	△ kg
80380030	30 x 72	15	4

8041 Holding device for spanners

for perforated panel No 8002, Mobile workbench No WB620 and Tool trolleys No 95, 95VA, 98VA.



Code	mm	△△ g	△ kg
80410235	235 x 144 x 47	62	1

8050 Spring clip

for perforated panel No 8002, Mobile workbench No WB620, Tool trolleys No 95, 95VA, 98VA and Tool boxes No 13216/2, 13216/3, 13216/4.



Code	size	mm	△△ g	△ kg
81485006	6	6	28	5
81485012	12	12	35	5

Tool cases, hard shell

13209/1 Tool case, hard shell, base model

sturdy aluminium frame, 2 locks, ergonomically shaped carrying handle, robust jointed lid-prop, tool-holder panel for storing tools from both sides, with 21 pockets and integrated document pouch. ABS insert can be subdivided and includes cover with 6 pockets.



Code	Width mm	Height mm	Depth mm	⚖️ kg
81 62 0002	460	310	160	4.46

13209/2 Tool case, hard shell, medium model

as for No 13209/1, but with an additional combination lock, tool-holder panel with 13 pockets and 26 rubber-loop holders, separate document pouch in the lid, ABS inlay tray with 13 pockets and 8 rubber-loop holders.



Code	Width mm	Height mm	Depth mm	⚖️ kg
81 62 0003	460	310	180	5.1

13209 Tool case, hard shell, premium model

as for No 13209/1, but with an additional combination lock, tool-holder panel with 13 pockets and 26 rubber-loop holders, additional tool-holder panel with 11 pockets and a smaller components pouch, separate document pouch in the lid, ABS inlay tray with 13 pockets and 8 rubber-loop holders.



Code	Width mm	Height mm	Depth mm	⚖️ kg
81 62 0001	460	310	180	6

Workshop sets

801N Large tool set













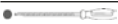

127 Tools

Code	⚖️ kg
9784 12 10	28.6
No 10/12	sizes 6 x 7; 8 x 9; 10 x 11; 12 x 13; 14 x 15; 16 x 17; 18 x 19; 20 x 22; 21 x 23; 24 x 27; 25 x 28; 30 x 32 mm
No 12/10	sizes 4; 4.5; 5; 5.5; 6; 7; 8; 9; 10; 11 mm
No 20/12	sizes 6 x 7; 8 x 9; 10 x 11; 12 x 13; 14 x 15; 16 x 17; 18 x 19; 20 x 22; 21 x 23; 24 x 27; 25 x 28; 30 x 32 mm
No 29	sizes 10 x 11; 12 x 13; 14 x 15; 16 x 18; 17 x 19; 21 x 23 mm
No 35c Pkw	sizes 17; 19; 22; 1/2" ■
No 39	400 mm (2x)
No 39/1	600 mm (2x)
No 50	1/2" ○ sizes 10; 11; 12; 13; 14; 15; 16; 17; 18; 19; 20; 21; 22; 23; 24; 25; 26; 27; 28; 30; 32 mm
No 51	1/2" ○ sizes 13; 16 mm-5/8"; 17; 18; 19 mm; 20.8 mm-13/16"; 22; 24; 27; 30; 32 mm
No 54	1/2" ○ sizes 4; 5; 6; 8; 10; 12; 14 mm
No 501	1/2" ■ 433 mm
No 504/15	1/2" ■ 397 mm
No 506	1/2" ■ 300 mm
No 509/2	1/2" ■ ○ 52 mm
No 509/5	1/2" ■ ○ 130 mm
No 509/10	1/2" ■ ○ 255 mm
No 510	1/2" ■ ○ 71 mm
No 512	1/2" ■
No 100/8	200 mm
No 103	150 mm
No 104	120 x 4 mm
No 105	100 x 10 mm
No 4622	size 2 (1.2 x 6.5 x 125 mm) size 3 (1.2 x 8.0 x 150 mm) size 5 (2.0 x 12.0 x 200 mm)
No 4628	size 2 (0.6 x 3.5 x 75 mm) size 4 (0.8 x 4.0 x 125 mm)
No 4630	sizes 1; 2; 3
No 4724	size 2 (1.0 x 5.5 x 25 mm)
No 65 01 6 180	
No 65 29 6 200	
No 65 30 6 200	
No 65 43 4 002	
No 65 45 4 002	
No 65 54 4 250	
No 65 64 2 250	
No 66 02 6 160	

Continuation see next page























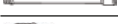

Factory and workshop equipment, sets of tools

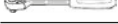

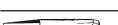



















1

	No 10670	310 mm
	No 10676	85 x 12 x 315 mm
	No 10960	500 g
	No 11095/13	0.05-1 mm
	No 12025	210 mm
	No 12030	260 mm
	No 12035	210 mm
	No 12050	300 mm
	No 12150	200 mm
	No 12200	145 mm
	No 12250	
	No 12320	
	No 12375	
	No 12935/3	3 m

802N Large tool set











129 Tools

Code		⚖ kg
97840312		28.1
	No 12/10	sizes 4; 4.5; 5; 5.5; 6; 7; 8; 9; 10; 11 mm
	No 13/26	sizes 6; 7; 8; 9; 10; 11; 12; 13; 14; 15; 16; 17; 18; 19; 20; 21; 22; 23; 24; 25; 26; 27; 28; 29; 30; 32 mm
	No 29	sizes 10 x 11; 12 x 13; 14 x 15; 16 x 18; 17 x 19; 21 x 23 mm
	No 35c Pkw	sizes 17; 19; 22; 1/2" ■
	No 39	400 mm (2x)
	No 39/1	600 mm (2x)
	No 50	1/2" ○ sizes 10; 11; 12; 13; 14; 15; 16; 17; 18; 19; 20; 21; 22; 23; 24; 25; 26; 27; 28; 30; 32 mm
	No 51	1/2" ○ sizes 13; 16 mm-5/8"; 17; 18; 19 mm; 20.8 mm-13/16"; 22; 24; 27; 30; 32 mm
	No 54	1/2" ○ sizes 4; 5; 6; 8; 10; 12; 14 mm
	No 501	1/2" ■ 433 mm
	No 504/15	1/2" ■ 397 mm
	No 506	1/2" ■ 300 mm
	No 509/2	1/2" ■ ○ 52 mm
	No 509/5	1/2" ■ ○ 130 mm
	No 509/10	1/2" ■ ○ 255 mm
	No 510	1/2" ■ ○ 71 mm
	No 512	1/2" ■
	No 100/8	200 mm
	No 103	150 mm
	No 104	120 x 4 mm
	No 105	100 x 10 mm
	No 4622	size 2 (1.2 x 6.5 x 125 mm) size 3 (1.2 x 8.0 x 150 mm) size 5 (2.0 x 12.0 x 200 mm)
	No 4628	size 2 (0.6 x 3.5 x 75 mm) size 4 (0.8 x 4.0 x 125 mm)
	No 4630	sizes 1; 2; 3

	No 4724	size 2 (1.0 x 5.5 x 25 mm)
	No 65 01 6 180	
	No 65 29 6 200	
	No 65 30 6 200	
	No 65 43 4 002	
	No 65 45 4 002	
	No 65 54 4 250	
	No 65 64 2 250	
	No 66 02 6 160	
	No 10670	310 mm
	No 10676	85 x 12 x 315 mm
	No 10960	500 g
	No 11095/13	0.05-1 mm
	No 12025	210 mm
	No 12030	260 mm
	No 12035	210 mm
	No 12050	300 mm
	No 12150	200 mm
	No 12200	145 mm
	No 12250	
	No 12320	
	No 12375	
	No 12935/3	3 m

803N Large tool set

164 Tools

Code		⚖ kg
97842613		17.8
	No 10/12	sizes 6 x 7; 8 x 9; 10 x 11; 12 x 13; 14 x 15; 16 x 17; 18 x 19; 20 x 22; 21 x 23; 24 x 27; 25 x 28; 30 x 32 mm
	No 10a	sizes 1/4 x 5/16; 3/8 x 7/16; 1/2 x 9/16; 5/8 x 11/16; 3/4 x 7/8; 15/16 x 1"
	No 12/10 No 12a/13	sizes 4; 4.5; 5; 5.5; 6; 7; 8; 9; 10; 11 mm sizes 5/32; 3/16; 13/64; 7/32; 15/64; 1/4; 9/32; 5/16; 11/32; 3/8; 7/16; 1/2; 9/16"
	No 13	sizes 8; 9; 10; 11; 12; 13; 14; 15; 16; 17; 18; 19 mm
	No 13a	sizes 3/8; 7/16; 1/2; 9/16; 5/8; 11/16; 3/4"
	No 21	sizes 6 x 7; 8 x 9; 10 x 11; 12 x 13; 14 x 15; 17 x 19 mm
	No 20a	sizes 1/4 x 5/16; 3/8 x 7/16; 1/2 x 9/16; 3/4 x 7/8; 15/16 x 1"
	No 23/8	sizes 6 x 7; 8 x 9; 10 x 11; 12 x 13; 14 x 15; 16 x 17; 18 x 19; 20 x 22 mm
	No 230a	sizes 3/8 x 7/16; 1/2 x 9/16; 9/16 x 5/8; 11/16 x 3/4; 13/16 x 7/8; 15/16 x 1"
	No 50	1/2" ○ sizes 10; 11; 12; 13; 14; 15; 16; 17; 18; 19; 20; 21; 22; 23; 24; 27; 30; 32 mm
	No 50a	1/2" ○ sizes 3/8; 7/16; 1/2; 9/16; 5/8; 11/16; 3/4; 13/16; 7/8; 15/16; 1; 1 1/16; 1 1/8; 1 3/16; 1 1/4"

	No 501	1/2" ■ 433 mm
	No 504/15	1/2" ■ 397 mm
	No 506	1/2" ■ 300 mm
	No 509/2	1/2" ■ ○ 52 mm
	No 509/5	1/2" ■ ○ 130 mm
	No 509/10	1/2" ■ ○ 255 mm
	No 510	1/2" ■ ○ 71 mm
	No 512	1/2" ■
	No 100	150 mm
	No 105	120 x 12 mm
	No 108	150 x 4; 150 x 6 mm
	No 4620	size 3 (1.0 x 5.5 x 100 mm) size 4 (1.2 x 6.5 x 150 mm) size 5 (1.6 x 8.0 x 175 mm) size 6 (1.6 x 10.0 x 200 mm)
	No 4628	size 2 (0.6 x 3.5 x 75 mm)
	No 4630	sizes 1; 2; 3
	No 4724	size 2 (1.0 x 5.5 x 25 mm)
	No 65 01 6 200	
	No 65 09 5 160	
	No 65 51 6 240	
	No 66 02 6 160	
	No 10760CV/9	sizes 1.5; 2; 2.5; 3; 4; 5; 6; 8; 10 mm
	No 10760aCV/10T	sizes 1/16; 5/64; 3/32; 1/8; 5/32; 3/16; 7/32; 1/4; 5/16; 3/8"
	No 10970	1 lb.
	No 12050	300 mm

















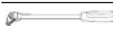





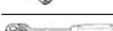

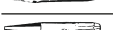



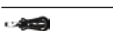

804N Large tool set

		Code	⚖ kg
		9784 27 14	12.7
	No 12/10	sizes 4; 4.5; 5; 5.5; 6; 7; 8; 9; 10; 11 mm	
	No 13	sizes 6; 7; 8; 9; 10; 11; 12; 13; 15; 16; 17; 18; 19; 21; 22; 24; 27; 30; 32 mm	
	No 40/13/6	1/4" ○ No 40 sizes 3.5; 4; 4.5; 5; 5.5; 6; 7; 8; 9; 10; 11; 12; 13 mm; No 400; 404; 405/2; 405/6; 407; 415	
	No 50	1/2" ○ sizes 10; 12; 13; 14; 15; 16; 17; 18; 19; 21; 22; 24; 27; 30; 32 mm	
	No 51	1/2" ○ sizes 16 mm-5/8"; 20.8 mm-13/16"	
	No 506	1/2" ■ 300 mm	
	No 509/5	1/2" ■ ○ 130 mm	
	No 509/10	1/2" ■ ○ 255 mm	
	No 510	1/2" ■ ○ 71 mm	
	No 512	1/2" ■	
	No 100/8	200 mm	
	No 103	200 mm	
	No 105-8/6 K	No 105/120 x 10 mm No 108/150 x 2.5; 150 x 3; 150 x 4; 150 x 5; 150 x 6 mm	
	No 4620	size 1 (0.6 x 3.5 x 75 mm) size 2 (0.8 x 4.0 x 100 mm) size 3 (1.0 x 5.5 x 125 mm) size 4 (1.2 x 6.5 x 150 mm) size 5 (1.6 x 8.0 x 175 mm)	
	No 4628	size 1 (0.4 x 2.5 x 60 mm)	
	No 4630	size 1; size 2	
	No 65 01 6 180		
	No 65 29 6 200		
	No 65 51 6 240		
	No 65 64 2 250		
	No 66 02 6 160		
	No 10760CV/9	sizes 1.5; 2; 2.5; 3; 4; 5; 6; 8; 10 mm	
	No 10955	35 mm ∅	
	No 10960	500 g	
	No 11095/20	0.05-1 mm	
	No 12251		
	No 12321		
	No 12375		

Factory and workshop equipment, sets of tools















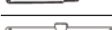









811N
Car tool set

84 Tools

Code		⚖ kg
9784 13 11		16.3
 No 10/12	sizes 6 x 7; 8 x 9; 10 x 11; 12 x 13; 14 x 15; 16 x 17; 18 x 19; 20 x 22; 21 x 23; 24 x 27; 25 x 28; 30 x 32 mm	
 No 20/12	sizes 6 x 7; 8 x 9; 10 x 11; 12 x 13; 14 x 15; 16 x 17; 18 x 19; 20 x 22; 21 x 23; 24 x 27; 25 x 28; 30 x 32 mm	
 No 39	400 mm (2X)	
 No 50	1/2" \odot sizes 10; 11; 12; 13; 14; 15; 16; 17; 19; 21; 22; 23; 24; 26; 27; 30; 32 mm	
 No 51	1/2" \odot sizes 16 mm-5/8"; 20.8 mm-13/16"	
 No 54	1/2" \odot sizes 4; 5; 6; 8; 10; 12; 14 mm	
 No 504/15	1/2" \blacksquare 397 mm	
 No 506	1/2" \blacksquare 300 mm	
 No 509/2	1/2" $\blacksquare \odot$ 52 mm	
 No 509/5	1/2" $\blacksquare \odot$ 130 mm	
 No 509/10	1/2" $\blacksquare \odot$ 255 mm	
 No 510	1/2" $\blacksquare \odot$ 71 mm	
 No 512	1/2" \blacksquare	
 No 100/8	200 mm	
 No 103	150 mm	
 No 104	120 x 4 mm	
 No 105	100 x 10 mm	
 No 4622	size 2 (1.2 x 6.5 x 125 mm) size 3 (1.2 x 8.0 x 150 mm) size 5 (2.0 x 12.0 x 200 mm)	
 No 4628	size 2 (0.6 x 3.5 x 75 mm) size 4 (0.8 x 4.0 x 125 mm)	
 No 4630	sizes 1; 2; 3	
 No 4724	size 2 (1.0 x 5.5 x 25 mm)	
 No 65 01 6 180		
 No 65 29 6 200		
 No 65 30 6 200		
 No 65 43 4 002		
 No 65 45 4 002		
 No 65 54 4 250		
 No 65 64 2 250		
 No 66 02 6 160		
 No 10670	310 mm	
 No 10676	85 x 12 x 315 mm	
 No 10960	500 g	
 No 12375		

3027
Electrician tool set

85 Tools

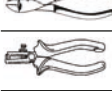
Code		⚖ kg
9784 31 01		6.3
 No 13 No 13/9	sizes 6; 7 mm sizes 9; 10; 11; 12; 13; 14; 17; 19; 22 mm	
 No 40/23/6N	1/4" \odot No 40 sizes 5; 5.5; 6; 7; 8; 9; 10; 11; 12; 13; 14 mm No 41K sizes 0.6 x 3.5; 1 x 5.5; 1.2 x 8 mm No 44K: 3; 4; 5; 6; 8 mm No 44P: sizes 1; 2; 3; 4 No 400; 404; 405/2; 405/6; 407; 415	
 No 46	3/8" \odot sizes 12; 20.8 mm	
 No 4600	3/8" \odot size 16 mm	
 No 425	3/8" \blacksquare 165 mm	
 No 428	3/8" $\blacksquare \odot$ 46 mm	
 No 427/6	3/8" $\blacksquare \odot$ 160 mm	
 No 4628	size 2 (0.6 x 3.5 x 75 mm) size 4 (0.8 x 4.0 x 125 mm) size 6 (1.0 x 5.5 x 200 mm)	
 No 4630	size 1; size 2	
 No 4724	size 2 (1.0 x 5.5 x 25 mm)	
 No 4734	size 2	
 No 10546	size 3	
 No 10551	size 1 x 2	
 No 10760CV/9	sizes 1.5; 2; 2.5; 3; 4; 5; 6; 8; 10 mm	
 No 7756	3-48 Volt	
 No 65 01 5 180		
 No 65 29 5 160		
 No 65 30 5 160		
 No 65 51 6 240		
 No 66 02 6 140		
 No 66 22 5 160		
 No 6638		
 No 10956	\varnothing 35 mm	
 No 1551	for contact sizing \square 2.8 mm	
 No 1552	for contact sizing \square 5.8 mm	
 No 1560	Content: 1 Piece No 1501 ejection tool for contact sizing \varnothing 1.5 mm 1 Piece No 1502 ejection tool for contact sizing \varnothing 3.5 mm 1 Piece No 1503 ejection tool for contact sizing \varnothing 4.0 mm ABS (trucks) resp. mounting bush No 1523 2 Pieces No 1511 dismounting bush \varnothing 1.5 mm (1 Piece assembled) 2 Pieces No 1512 dismounting bush \varnothing 3.5 mm (1 Piece assembled) 2 Pieces No 1513 dismounting bush \varnothing 4.0 mm 1 Piece No 1523 mounting bush (ABS)	

841N Construction machinery set

129 tools

Code	⚙️ kg
97 84 14 18	35.9
No 10/9	sizes 6 x 7; 8 x 9; 10 x 11; 12 x 13; 14 x 15; 16 x 17; 18 x 19; 20 x 22; 21 x 24 mm
No 14	sizes 6; 7; 8; 9; 10; 11; 12; 13; 14; 15; 16; 17; 18; 19; 20; 21; 22; 24; 27; 30; 32; 34; 36 mm
No 40/13/6	1/4" No 40 sizes 3.5; 4; 4.5; 5; 5.5; 6; 7; 8; 9; 10; 11; 12; 13 mm; No 400; 404; 405/2; 405/6; 407; 415
No 50/16/6	1/2" No 50: sizes 10; 11; 12; 13; 14; 15; 16; 17; 18; 19; 21; 22; 24; 27; 30; 32 mm No 506; 509/5; 509/10; 506; 510; 512
No 504/15	1/2" 397 mm
No 514	3/4" 1/2"
No 55/9/6N	3/4" No 55: sizes 32; 34; 36; 38; 41; 46; 50; 55; 60 mm No 552; 554; 556; 558; 559/8; 559/16
No 568	1/2" 3/4"
No 102-5/6T	No 104/120 x 2; 120 x 4 mm No 105/120 x 10 mm No 106/125 mm; 150 mm No 107/125 mm
No 4840	sizes 1; 2
No 4891	⊖ 4820: 0.6 x 3.5 x 75 mm 0.8 x 4.0 x 100 mm 1.0 x 5.5 x 125 mm 1.2 x 6.5 x 150 mm ⊕ 4830: sizes 1; 2
No 10760CV/9	sizes 1.5; 2; 2.5; 3; 4; 5; 6; 8; 10 mm
No 65 01 5 180	
No 65 31 5 170	
No 65 63 2 250	
No 65 67 2 280	
No 65 72 6 240	
No 66 00 5 160	
No 10956	∅ 35 mm
No 10960	300; 500 g
No 11095/20	20 blades 0.05-1 mm
No 12050	300 mm
No 12050R	10 blades
No 12374	
No 12600	1800 g
No 12935/3	3 m

Tool sets for aerospace industry

13200a Basic tool set for aircraft mechanics (piston engine)















178 Tools

Code	⚙️ kg
97 84 60 11	15
No 12a/13	sizes 5/32; 3/16; 13/64; 7/32; 15/64; 1/4; 9/32; 5/16; 11/32; 3/8; 7/16; 1/2; 9/16"
No 13a	sizes 3/16; 13/64; 7/32; 15/64; 1/4; 9/32; 5/16; 11/32; 3/8; 7/16; 1/2; 9/16; 19/32; 5/8; 11/16; 3/4; 25/32; 13/16; 7/8; 15/16; 1"
No 230a	sizes 1/4 x 5/16; 5/16 x 11/32; 3/8 x 7/16; 7/16 x 1/2; 1/2 x 9/16; 9/16 x 5/8; 11/16 x 3/4; 13/16 x 7/8; 15/16 x 1"
No 4025	size 4
No 40aD/30/7QR	1/4" No 40a: sizes 1/8" No 40aD: sizes 5/32; 3/16; 7/32; 1/4; 9/32; 5/16; 11/32; 3/8; 7/16; 1/2; 9/16" No 40aDL: sizes 5/32; 3/16; 7/32; 1/4; 9/32; 5/16; 11/32; 3/8; 7/16; 1/2; 9/16" No 402a: sizes 1/4; 9/32; 5/16; 11/32; 3/8; 7/16; 1/2" No 400QR; 405/2QR (2x); 405/6QR; 407QR; 412; 415 SG-QR
No 409	3/8" 1/4"
No 4155GB N	1/4"
No 46a	3/8" sizes 7/16; 1/2; 9/16; 5/8"
No 427/18	3/8" 455 mm
No 431	1/4" 3/8"
No 45a/22/8QR	3/8" No 45a: sizes 1/4; 5/16; 11/32; 3/8; 7/16; 1/2; 9/16; 5/8; 11/16; 3/4; 13/16; 7/8; 15/16; 1" No 47a: sizes 5/16; 3/8; 7/16; 1/2; 9/16; 5/8; 11/16; 3/4" No 427/10QR; 427/6QR; 427/3QR; 428QR; 435SG-QR; 442; 443; 453
No 1220	size 0
No 1221	size 1
No 1222	size 2
No 1223	size 3
No 13010	sizes 0; 1; 2; 3; 4; 5; 6; 8; 10
No 4006/1	1/4"
No 12503	1/4"
No 4622	size 1 (1.0 x 5.5 x 100 mm) size 3 (1.2 x 8.0 x 150 mm) size 4 (1.6 x 10.0 x 175 mm)
No 4632	sizes 1; 2; 3
No 10760aCV/13	sizes 0.028; 0.035; 0.050; 1/16; 5/64; 3/32; 7/64; 1/8; 9/64; 5/32; 3/16; 7/32; 1/4"
No 65 01 5 180	
No 65 10 5 190	
No 65 31 5 170	
No 65 51 6 240	
No 65 75 1 280	
No 66 00 5 180	

Continuation see next page





















Factory and workshop equipment, sets of tools













1

	No 105-8/6 K	No 105/120 x 10 mm; No 108/150 x 2.5; 150 x 3; 150 x 4; 150 x 5; 150 x 6 mm
	No 10670	215 mm
	No 10955	∅ 27 mm
	No 10960	300 g
	No 12320	
	No 12321	
	No 12600	500 g
	No 12900	
	No 12921N	∅ 50 mm
	No 12922E	∅ 6 mm
	No 12935/3	3 m
	No 13110	300 mm
	No 13126-1	
	No 13148	

13205a Standard aircraft maintenance tool set

















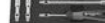

131 Tools

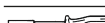
Code		⚖ kg
97846012		7.8
	No 12a/13	sizes 5/32; 3/16; 13/64; 7/32; 15/64; 1/4; 9/32; 5/16; 11/32; 3/8; 7/16; 1/2; 9/16"
	No 13a	sizes 3/16; 13/64; 7/32; 15/64; 1/4; 9/32; 5/16; 11/32; 3/8; 7/16; 1/2; 9/16; 19/32; 5/8; 11/16; 3/4"
	No 230a	sizes 5/16 x 11/32; 3/8 x 7/16; 7/16 x 1/2; 1/2 x 9/16; 9/16 x 5/8; 11/16 x 3/4"
	No 4025	size 4
	No 409	3/8" ■ 1/4" ○
	No 40aD/30/7QR	1/4" ○ No 40a: sizes 1/8" No 40aD: sizes 5/32; 3/16; 7/32; 1/4; 9/32; 5/16; 11/32; 3/8; 7/16; 1/2; 9/16" No 40aDL: sizes 5/32; 3/16; 7/32; 1/4; 9/32; 5/16; 11/32; 3/8; 7/16; 1/2; 9/16" No 402a: sizes 1/4; 9/32; 5/16; 11/32; 3/8; 7/16; 1/2" No 400QR; 405/2QR (2x); 405/6QR; 407QR; 412; 415 SG-QR
	No 1161-1166	0.5 x 4; 0.6 x 3.5; 0.6 x 4.5; 0.8 x 4; 0.8 x 5.5; 1 x 5.5 mm
	No 1220-1223	sizes 0; 1; 2; 3
	No 13008	sizes 0; 1; 2; 3; 4; 5
	No 13010	sizes 0; 1; 2; 3; 4; 5; 6; 8; 10
	No 4006/1	1/4" ○
	No 12503	1/4" ○
	No 4622	size 1 (1.0 x 5.5 x 100 mm) size 3 (1.2 x 8.0 x 150 mm) size 4 (1.6 x 10.0 x 175 mm)
	No 4632	sizes 1; 2; 3
	No 65 01 5 180	
	No 65 10 5 190	
	No 65 31 5 170	
	No 65 51 6 240	
	No 65 75 1 220	
	No 66 00 5 180	

	No 105-8/6 K	No 105/120 x 10 mm No 108/150 x 2.5; 150 x 3; 150 x 4; 150 x 5; 150 x 6 mm
	No 10955	∅ 27 mm
	No 10960	300 g
	No 12025	210 mm
	No 12030	260 mm
	No 12035	210 mm
	No 12036	250 mm
	No 12053	
	No 12321	
	No 12900N	
	No 12921N	∅ 40 mm
	No 13110	300 mm
	No 13126-1	

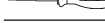
13207a Electricians set in tool case No 13209

111 Tools

Code		⚖ kg
98810322		12.5
	No 13a	sizes 3/16; 13/64; 7/32; 15/64; 1/4; 9/32; 5/16; 11/32; 3/8; 7/16; 1/2; 9/16; 19/32; 5/8; 11/16; 3/4"
	No 12a/13	sizes 5/32; 3/16; 13/64; 7/32; 15/64; 1/4; 9/32; 5/16; 11/32; 3/8; 7/16; 1/2; 9/16"
	No 40a	1/4" ○ sizes 1/8; 5/32"
	No 400QR	1/4" ■ 150 mm
	No 40aD/12/7QR	1/4" ○ No 40a: sizes 1/8" No 40aD: sizes 5/32; 3/16; 7/32; 1/4; 9/32; 5/16; 11/32; 3/8; 7/16; 1/2; 9/16" No 400QR; 405/2QR (2x); 405/6QR; 407QR; 412; 415SG-QR
	No 4006/1	1/4" ○
	No 4660 VDE	size 1 (0.4 x 2.5 x 75 mm) size 3 (0.6 x 3.5 x 100 mm) size 5 (1.0 x 5.5 x 125 mm) size 6 (1.2 x 6.5 x 150 mm)
	No 4665 VDE	sizes 0; 1; 2
	No 10760aCV/13	sizes 0.028; 0.035; 0.050; 1/16; 5/64; 3/32; 7/64; 1/8; 9/64; 5/32; 3/16; 7/32; 1/4"
	No 65 01 5 160. No 65 01 5 180	
	No 65 24 5 160	
	No 65 29 5 200	
	No 65 30 5 200	
	No 65 31 5 170	
	No 65 15 6 125	
	No 65 76 5 231	
	No 66 00 5 130	
	No 66 02 5 180	
	No 66 23 5 160	

	No 105-8/6 K	No 105/120 x 10 mm No 108/150 x 2.5; 150 x 3; 150 x 4; 150 x 5; 150 x 6 mm
	No 10960	300 g
	No 12053	
	No 12320	
	No 12600	500 g
	No 12921N	∅ 40 mm
	No 12922E	∅ 6 mm
	No 12941	
	No 13008	sizes 0; 1; 2; 3; 4; 5
	No 13010	sizes 0; 1; 2; 3; 4; 5
	No 13126-1	
	No 13130	
	No 13131	
	No 13209	

13208a Board case for aircraft in tool case No 13209

57 Tools

Code		⚖ kg
98 81 03 23		8.9
No 13a	sizes 1/4; 9/32; 5/16; 11/32; 3/8; 7/16; 1/2"	
No 4025	sizes 4; 6; 8	
No 1220	size 0	
No 1221	size 1	
No 1222	size 2	
No 1223	size 3	
No 13008	sizes 0; 1; 2; 3; 4; 5; 6	
No 13010	sizes 0; 1; 2; 3; 4; 5; 6; 8; 10	
No 4006/1	1/4" ○	
No 4622	size 1 (1.0 x 5.5 x 100 mm) size 3 (1.2 x 8.0 x 150 mm) size 4 (1.6 x 10.0 x 175 mm)	
No 4632	sizes 1; 2; 3	
No 10760aCV/13	sizes 0.028; 0.035; 0.050; 1/16; 5/64; 3/32; 7/64; 1/8; 9/64; 5/32; 3/16; 7/32; 1/4"	
No 65 01 5 180		
No 65 10 5 190		
No 65 51 6 240		
No 65 76 5 231		
No 66 00 5 180		
No 12320		
No 13126-1		
	No 13209	

13210 Electronics set in tool case No 13209

101 Tools

Code		⚖ kg
98 81 03 01		10.7
No 13	sizes 5.5; 6; 7; 8; 9; 10; 11; 12; 13; 14 mm	
No 13a	sizes 3/16; 7/32; 1/4; 3/8; 1/2"	
No 16	sizes 3.2; 3.5; 4; 4.5; 5 mm	
No 4025	size 4	
No 4621	size 5 (1.2 x 8.0 x 160 mm)	
No 4630	sizes 0; 1; 2	
No 4660 VDE	size 1 (0.4 x 2.5 x 75 mm) size 4 (0.8 x 4.0 x 100 mm) size 6 (1.2 x 6.5 x 150 mm)	
No 4724	size 1 (0.6 x 3.5 x 25 mm) size 2 (1.0 x 5.5 x 25 mm)	
No 4753	● sizes 0.7; 0.9; 1.3 mm	
No 4797	⊖ 4751: 0.3 x 1.5; 0.4 x 2; 0.4 x 2.5; 0.5 x 3 mm ⊕ 4752: No 00. No 0; No 1	
No 10546	size 2 (0.8 x 4.0 x 100 mm) size 3 (1.0 x 5.5 x 125 mm)	
No 10554	220-250 Volt	
No 10760aCV/13	sizes 0.028; 0.035; 0.050; 1/16; 5/64; 3/32; 7/64; 1/8; 9/64; 5/32; 3/16; 7/32; 1/4"	
No 10765	sizes 2; 2.5; 3; 4 mm	
No 12500N	sizes 6; 7 mm	
No 018/3		
No 109	sizes 1; 2; 3; 4; 5; 6; 7; 8	
No 65 01 5 160		
No 65 11 5 135		
No 65 32 5 170		
No 65 36 5 160		
No 66 04 6 110		
No 66 06 6 130		
No 66 23 5 160		
No 12900		
No 10971		
No 12921N	∅ 50 mm	
No 13100		
No 13148		
Drip oiler		
Magnetic lifter		
Electronics tweezers		
Electronics tweezers		
Extractor hook set		

Continuation see next page

Factory and workshop equipment, sets of tools

1



Test equipment set for safety applications



Universal soldering iron



Solder

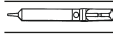

Solder removing pump, antistatic



Blade holders with blades

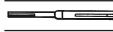

Lamp extractor



Magnifying glass



2 Screw-holding screwdrivers



Tweezers



Stripper



Set of soldering tools



Solder removing wire



Hand vice



Inspection mirror, insulated, Ø 40 mm



No 13209

13211a Sheetmetal set

53 Tools

Code		△△ kg
97846008		9
No 10a	sizes 1/4 x 5/16; 3/8 x 7/16; 1/2 x 9/16"	
No 13a	sizes 7/32; 11/32"	
No 230a	sizes 1/4 x 5/16; 3/8 x 7/16; 1/2 x 9/16"	
No 4025	size 8	
No 442	1/4" ○ 3/8" ○	
No 443	5/16" ○ 3/8" ○	
No 453	3/8" ■	
No 103	150 mm	
No 104-5/6D	No 104/120 x 2; 120 x 3; 120 x 4; 120 x 5; 120 x 6 mm No 105/120 mm	
No 104	120 x 8 mm	
No 108/6D	No 108/150 x 2.5; 150 x 3; 150 x 4; 150 x 5; 150 x 6; 150 x 8 mm	
No 4622	size 1 (1.0 x 5.5 x 100 mm) size 3 (1.2 x 8.0 x 150 mm) size 4 (1.6 x 10.0 x 175 mm) size 6 (2.5 x 14.0 x 250 mm)	
No 4630	sizes 1; 2; 3	
No 4734	size 2	
No 65 01 6 180		
No 65 64 2 175		
No 66 02 6 160		
No 10670	265 mm	
No 10955	32 mm Ø	



No 10970 3/4; 1 1/2 lb.



No 12025 210 mm

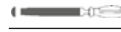

No 12030 260 mm



No 12035 210 mm



No 12036 260 mm



No 12050 465 mm



No 12200 145 mm



No 12378



No 12752R



No 12800



No 12900N

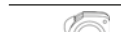

No 12935/3 3 m



No 13110 300 mm

13213a Engine mechanics set

129 Tools

Code		△△ kg
97846010		12.1
No 13a	sizes 19/32; 5/8; 11/16; 3/4"	
No 130a	sizes 1/4; 9/32; 5/16; 11/32; 3/8; 7/16; 1/2; 9/16"	
No 24	sizes 1/4 x 5/16; 5/16 x 3/8; 3/8 x 7/16; 1/2 x 9/16; 5/8 x 3/4"	
No 230a	sizes 1/4 x 5/16; 5/16 x 3/8; 3/8 x 7/16; 7/16 x 1/2; 9/16 x 5/8; 5/8 x 3/4; 11/16 x 3/4"	
No 405	1/4" ■ ○ sizes 10; 14	
No 413	1/4" ■	
No 415SGB N	1/4" ○	
No 40aD/30/7QR	1/4" ○ No 40a: sizes 1/8" No 40aD: sizes 5/32; 3/16; 7/32; 1/4; 9/32; 5/16; 11/32; 3/8; 7/16; 1/2; 9/16" No 40aDL: sizes 5/32; 3/16; 7/32; 1/4; 9/32; 5/16; 11/32; 3/8; 7/16; 1/2; 9/16" No 402a: sizes 1/4; 9/32; 5/16; 11/32; 3/8; 7/16; 1/2" No 400QR; 405/2QR (2x); 405/6QR; 407QR; 412; 415 SG-QR	
No 45a/22/8QR	3/8" ○ No 45a: sizes 1/4; 5/16; 11/32; 3/8; 7/16; 1/2; 9/16; 5/8; 11/16; 3/4; 13/16; 7/8; 15/16; 1" No 47a: sizes 5/16; 3/8; 7/16; 1/2; 9/16; 5/8; 11/16; 3/4" No 427/10QR; 427/6QR; 427/3QR; 428QR; 435SG-QR; 442; 443; 453	
No 109	sizes 1; 2; 3; 4; 5	
No 4622	size 1 (1.0 x 5.5 x 100 mm) size 2 (1.2 x 6.5 x 125 mm) size 4 (1.6 x 10.0 x 175 mm) size 5 (2.0 x 12.0 x 200 mm)	
No 4631	sizes 1; 2	
No 4632	sizes 1; 2; 3	
No 10760aCV/10T	sizes 1/16; 5/64; 3/32; 1/8; 5/32; 3/16; 7/32; 1/4; 5/16; 3/8"	
No 65 16 5 200		
No 65 31 5 170		
No 65 51 6 240		

	No 65 75 1 220	
	No 66 00 5 160	
	No 10960	300 g
	No 11097/22	4-25/1000"
	No 12600	500 g
	No 12900N	
	No 12921N	∅ 50 mm

13214 Line maintenance set in tool box
No 13216/4

TCS QR

for maintenance on aeroplanes and helicopters, 122 Tools



Code	♂
98 81 48 03	kg
	27.5



96 83 08 04



96 83 08 06



96 83 17 94



96 83 07 95



96 83 08 05

	No 13	sizes 5.5; 6; 7; 8; 9; 10; 12; 13; 14; 15; 17; 19; 20; 21; 22; 24; 27; 30 mm
	No 16	sizes 3.2; 3.5; 4; 4.5; 5 mm
	No 25	sizes 7 x 8; 9 x 10; 12 x 13; 17 x 19 mm
	No 40	1/4" ∅ sizes 4; 4.5 mm
	No 40D	1/4" ∅ sizes 5; 5.5; 6; 7; 8; 9; 10; 11; 12; 13; 14 mm
	No 40L No 40DL	1/4" ∅ size 4.5 mm 1/4" ∅ sizes 5; 5.5; 6; 7; 8; 9; 10; 11; 12; 13; 14 mm
	No 402	1/4" ∅ sizes 6; 7; 8; 9; 10 mm

	No 405QR/2	1/4" ■ ∅ 54 mm
	No 405QR/6	1/4" ■ ∅ 150 mm
	No 407QR	1/4" ■ ∅ 38 mm
	No 409M	3/8" ■ 1/4" ∅
	No 415QR N	1/4" ■
	No 415SGB N	1/4" ∅
	No 412	1/4" ∅ ∅
	No 45	3/8" ∅ sizes 15; 17; 19; 21; 22; 24 mm
	No 46	3/8" ∅ sizes 15; 17; 19; 21 mm
	No 427QR/3	3/8" ■ ∅ 76 mm
	No 427QR/10	3/8" ■ ∅ 240 mm
	No 428QR	3/8" ■ ∅ 46 mm
	No 431	1/4" ■ 3/8" ∅
	No 432M	1/2" ■ 3/8" ∅
	No 435QR N	3/8" ■
	No 443	5/16" ∅ 3/8" ∅
	No 453	3/8" ■
	No 4000	
	No 1163	0.6 x 4.5 mm
	No 104	120 x 2; 120 x 3; 120 x 4; 120 x 5 mm
	No 109	sizes 2; 5
	No 4622	size 1 (1.0 x 5.5 x 100 mm) size 3 (1.2 x 8.0 x 150 mm)
	No 4632	sizes 1; 2; 3
	No 10767/9	sizes 1.5; 2; 2.5; 3; 4; 5; 6; 8; 10 mm
	No 65 16 5 200	
	No 65 32 5 170	
	No 65 51 6 240	
	No 65 64 2 175	
	No 65 75 1 220	
	No 66 00 5 160	
	No 10956	∅ 35 mm
	No 10960	500 g
	No 11095/20	0.05-1 mm
	No 12053	
	No 12320	
	No 12321	
	No 12600	270 g
	No 12900	
	No 12921N	∅ 50 mm
	No 12922E	∅ 6 mm
	No 12935/3	3 m
	No 13126-1	
	No 8050	size 6 (4x); size 12 (6x)
	No 13216/4	

Factory and workshop equipment, sets of tools

13214 WT/LR Line maintenance set in tool trolley No 13217



for maintenance on aeroplanes and helicopters, 121 Tools, Tool Trolley No 13217 and accessories see pages 17, 18.



Code	⚖️ kg
9881 4900	26.5

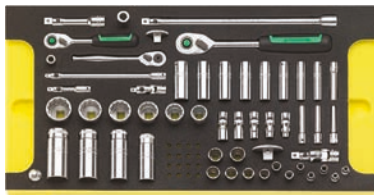

96 83 01 00



96 83 01 01



96 83 01 02



96 83 01 03



96 83 01 04



96 83 01 05

No 13	sizes 5.5; 6; 7; 8; 9; 10; 12; 13; 14; 15; 17; 19; 20; 21; 22; 24; 27; 30 mm
No 16	sizes 3.2; 3.5; 4; 4.5; 5 mm
No 25	sizes 7 x 8; 9 x 10; 12 x 13; 17 x 19 mm
No 40	1/4" ○ sizes 4; 4.5 mm
No 40D	1/4" ○ sizes 5; 5.5; 6; 7; 8; 9; 10; 11; 12; 13; 14 mm
No 40L	1/4" ○ size 4.5 mm
No 40DL	1/4" ○ sizes 5; 5.5; 6; 7; 8; 9; 10; 11; 12; 13; 14 mm

No 402	1/4" ○ sizes 6; 7; 8; 9; 10 mm
No 405QR/2	1/4" ■ ○ 54 mm
No 405QR/6	1/4" ■ ○ 150 mm
No 407QR	1/4" ■ ○ 38 mm
No 409M	3/8" ■ 1/4" ○
No 415QR N	1/4" ■
No 415SGB N	1/4" ○
No 412	1/4" ○ ○
No 45	3/8" ○ sizes 15; 17; 19; 21; 22; 24 mm
No 46	3/8" ○ sizes 15; 17; 19; 21 mm
No 427QR/3	3/8" ■ ○ 76 mm
No 427QR/10	3/8" ■ ○ 240 mm
No 428QR	3/8" ■ ○ 46 mm
No 431	1/4" ■ 3/8" ○
No 432M	1/2" ■ 3/8" ○
No 435QR N	3/8" ■
No 443	5/16" ○ 3/8" ○
No 453	3/8" ■
No 4008-1	
No 104	120 x 2; 120 x 3; 120 x 4; 120 x 5 mm
No 109	sizes 2; 5
No 4622	size 1 (1.0 x 5.5 x 100 mm) size 3 (1.2 x 8.0 x 150 mm)
No 4632	sizes 1; 2; 3
No 10767/9	sizes 1.5; 2; 2.5; 3; 4; 5; 6; 8; 10 mm
No 65 16 5 200	
No 65 32 5 170	
No 65 51 6 240	
No 65 64 2 175	
No 65 75 1 220	
No 66 00 5 160	
No 10956	∅ 35 mm
No 10960	500 g
No 11095/20	0.05-1 mm
No 12053	
No 12320	
No 12321	
No 12600	270 g
No 12900	
No 12921M	∅ 57 mm
No 12922E	∅ 6 mm
No 12935/3	3 m
No 13126-2	
No 13217-1 LR	

13214 WW Line maintenance set



for maintenance on aeroplanes and helicopters,
121 Tools, in TCS inlays (Tool Control System see page 53-71),
4x3/3 inlays for 4 drawers (No 98VA for 2 drawers),
suitable for Workbench No WB620, Tool trolleys 90, 95, 95VA, 98VA;
Magazine case No 920 and Wheely box No 922N.

Code	Δ kg
97 83 08 03	12.2



96 83 08 88



96 83 22 06

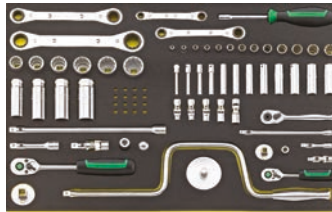

96 83 22 07



96 83 22 08

	No 13	sizes 5.5; 6; 7; 8; 9; 10; 12; 13; 14; 15; 17; 19; 20; 21; 22; 24; 27; 30 mm
	No 16	sizes 3.2; 3.5; 4; 4.5; 5 mm
	No 25	sizes 7 x 8; 9 x 10; 12 x 13; 17 x 19 mm
	No 40	1/4" sizes 4; 4.5 mm
	No 40D	1/4" sizes 5; 5.5; 6; 7; 8; 9; 10; 11; 12; 13; 14 mm
	No 40L	1/4" size 4.5 mm
	No 40DL	1/4" sizes 5; 5.5; 6; 7; 8; 9; 10; 11; 12; 13; 14 mm
	No 402	1/4" sizes 6; 7; 8; 9; 10 mm
	No 405QR/2	1/4" 54 mm
	No 405QR/6	1/4" 150 mm
	No 407QR	1/4" 38 mm
	No 409M	3/8" 1/4"
	No 415QR N	1/4"
	No 415SGB N	1/4"
	No 412	1/4"
	No 45	3/8" sizes 15; 17; 19; 21; 22; 24 mm
	No 46	3/8" sizes 15; 17; 19; 21 mm
	No 427QR/3	3/8" 76 mm
	No 427QR/10	3/8" 240 mm
	No 428QR	3/8" 46 mm
	No 431	1/4" 3/8"
	No 432M	1/2" 3/8"
	No 435QR N	3/8"
	No 443	5/16" 3/8"
	No 453	3/8"

	No 4000	
	No 104	120 x 2; 120 x 3; 120 x 4; 120 x 5 mm
	No 109	sizes 2; 5
	No 4622	size 1 (1.0 x 5.5 x 100 mm) size 3 (1.2 x 8.0 x 150 mm)
	No 4632	sizes 1; 2; 3
	No 10767/9	sizes 1.5; 2; 2.5; 3; 4; 5; 6; 8; 10 mm
	No 65 16 5 200	
	No 65 32 5 170	
	No 65 51 6 240	
	No 65 64 2 175	
	No 65 75 1 220	
	No 66 00 5 160	
	No 10956	∅ 35 mm
	No 10960	500 g
	No 11095/20	0.05-1 mm
	No 12053	
	No 12320	
	No 12321	
	No 12600	270 g
	No 12900	
	No 12921N	∅ 50 mm
	No 12922E	∅ 6 mm
	No 12935/3	3 m
	No 13126-1	



Factory and workshop equipment, sets of tools

13214a

Line maintenance set in tool box
No 13216/4



for maintenance on aeroplanes and helicopters, 123 Tools



Code	♻️
	kg
98814801	27.2



96 83 56 92



96 83 17 93



96 83 17 94



96 83 07 95



96 83 07 96

	No 13a	sizes 3/16; 13/64; 7/32; 15/64; 1/4; 9/32; 5/16; 11/32; 3/8; 7/16; 1/2; 9/16; 19/32; 5/8; 11/16; 3/4; 25/32; 13/16; 7/8; 15/16; 1; 1 1/16; 1 1/8"
	No 25a	sizes 1/4 x 5/16; 5/16 x 11/32; 3/8 x 7/16; 1/2 x 9/16"
	No 40aD	1/4" ○ sizes 3/16; 7/32; 1/4; 9/32; 5/16; 11/32; 3/8; 7/16; 1/2; 9/16"
	No 40aDL	1/4" ○ sizes 3/16; 7/32; 1/4; 9/32; 5/16; 11/32; 3/8; 7/16; 1/2; 9/16"
	No 402a	1/4" ○ sizes 1/4; 5/16; 3/8; 7/16; 1/2"
	No 405QR/2	1/4" ■ ○ 54 mm
	No 405QR/6	1/4" ■ ○ 150 mm
	No 407QR	1/4" ■ ○ 38 mm
	No 409M	3/8" ■ 1/4" ○
	No 415QR N	1/4" ■
	No 415SGB N	1/4" ○
	No 412	1/4" ○ ○

	No 45a	3/8" ○ sizes 1/2; 9/16; 19/32; 5/8; 11/16; 3/4; 15/16; 1"
	No 46a	3/8" ○ sizes 5/8; 11/16; 3/4; 7/8"
	No 427QR/3	3/8" ■ ○ 76 mm
	No 427QR/10	3/8" ■ ○ 240 mm
	No 428QR	3/8" ■ ○ 46 mm
	No 431	1/4" ■ 3/8" ○
	No 432M	1/2" ■ 3/8" ○
	No 435QR N	3/8" ■
	No 443	5/16" ○ 3/8" ○
	No 453	3/8" ■
	No 4000	
	No 1163	0.6 x 4.5 mm
	No 104	120 x 2; 120 x 3; 120 x 4; 120 x 5 mm
	No 109	sizes 2; 5
	No 4622	size 1 (1.0 x 5.5 x 100 mm) size 3 (1.2 x 8.0 x 150 mm)
	No 4632	sizes 1; 2; 3
	No 10767a/13	sizes 0.050; 1/16; 5/64; 3/32; 7/64; 1/8; 9/64; 5/32; 3/16; 7/32; 1/4; 5/16; 3/8"
	No 65 16 5 200	
	No 65 32 5 170	
	No 65 51 6 240	
	No 65 64 2 175	
	No 65 75 1 220	
	No 66 00 5 160	
	No 10956	∅ 35 mm
	No 10960	500 g
	No 11095/20	0.05-1 mm
	No 12053	
	No 12320	
	No 12321	
	No 12600	270 g
	No 12900	
	No 12921N	∅ 50 mm
	No 12922E	∅ 6 mm
	No 12935/3	3 m
	No 13126-1	
	No 8050	size 6 (4x); size 12 (6x)
	No 13216/4	

13214a
WT/LR Line maintenance set in tool trolley
No 13217



for maintenance on aeroplanes and helicopters, 122 Tools. Tool Trolley No 13217 and accessories see pages 17, 18.



Code	
98 81 49 05	kg 27

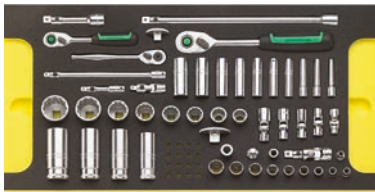

96 83 01 06



96 83 01 02



96 83 01 03



96 83 01 07



96 83 01 08



96 83 01 09

	No 13a	sizes 3/16; 13/64; 7/32; 15/64; 1/4; 9/32; 5/16; 11/32; 3/8; 7/16; 1/2; 9/16; 19/32; 5/8; 11/16; 3/4; 25/32; 13/16; 7/8; 15/16; 1; 1 1/16; 1 1/8"
	No 25a	sizes 1/4 x 5/16; 5/16 x 11/32; 3/8 x 7/16; 1/2 x 9/16"
	No 40aD	1/4" sizes 3/16; 7/32; 1/4; 9/32; 5/16; 11/32; 3/8; 7/16; 1/2; 9/16"
	No 40aDL	1/4" sizes 3/16; 7/32; 1/4; 9/32; 5/16; 11/32; 3/8; 7/16; 1/2; 9/16"

	No 402a	1/4" sizes 1/4; 5/16; 3/8; 7/16; 1/2"
	No 405QR/2	1/4" 54 mm
	No 405QR/6	1/4" 150 mm
	No 407QR	1/4" 38 mm
	No 409M	3/8" 1/4"
	No 415QR N	1/4"
	No 415SGB N	1/4"
	No 412	1/4"
	No 45a	3/8" sizes 1/2; 9/16; 19/32; 5/8; 11/16; 3/4; 15/16; 1"
	No 46a	3/8" sizes 5/8; 11/16; 3/4; 7/8"
	No 427QR/3	3/8" 76 mm
	No 427QR/10	3/8" 240 mm
	No 428QR	3/8" 46 mm
	No 431	1/4" 3/8"
	No 432M	1/2" 3/8"
	No 435QR N	3/8"
	No 443	5/16" 3/8"
	No 453	3/8"
	No 4008-1	
	No 104	120 x 2; 120 x 3; 120 x 4; 120 x 5 mm
	No 109	sizes 2; 5
	No 4622	size 1 (1.0 x 5.5 x 100 mm) size 3 (1.2 x 8.0 x 150 mm)
	No 4632	sizes 1; 2; 3
	No 10767a/13	sizes 0.050; 1/16; 5/64; 3/32; 7/64; 1/8; 9/64; 5/32; 3/16; 7/32; 1/4; 5/16; 3/8"
	No 65 16 5 200	
	No 65 32 5 170	
	No 65 51 6 240	
	No 65 64 2 175	
	No 65 75 1 220	
	No 66 00 5 160	
	No 10956	∅ 35 mm
	No 10960	500 g
	No 11095/20	0.05-1 mm
	No 12053	
	No 12320	
	No 12321	
	No 12600	270 g
	No 12900	
	No 12921M	∅ 57 mm
	No 12922E	∅ 6 mm
	No 12935/3	3 m
	No 13126-2	
	No 13217-1 LR	

Factory and workshop equipment, sets of tools

13214a WW Line Maintenance Set



1

for maintenance on aeroplanes and helicopters, 122 Tools, in TCS inlays (Tool Control System see page 53-71), 4x3/3 inlays for 4 drawers (No 98VA for 2 drawers), suitable for Workbench No WB620, Tool trolleys 90, 95, 95VA, 98VA, Magazine case No 920 and Wheely box No 922N.

Code	kg
9783 08 02	12.5



96 83 08 85

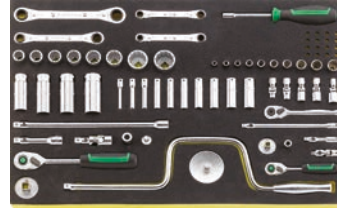

96 83 08 86

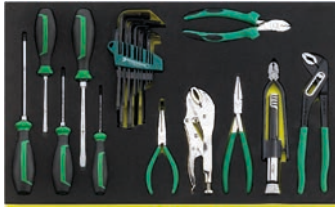

96 83 08 87



96 83 08 88

	No 13a	sizes 3/16; 13/64; 7/32; 15/64; 1/4; 9/32; 5/16; 11/32; 3/8; 7/16; 1/2; 9/16; 19/32; 5/8; 11/16; 3/4; 25/32; 13/16; 7/8; 15/16; 1; 1 1/16; 1 1/8"
	No 25a	sizes 1/4 x 5/16; 5/16 x 11/32; 3/8 x 7/16; 1/2 x 9/16"
	No 40aD	1/4" sizes 3/16; 7/32; 1/4; 9/32; 5/16; 11/32; 3/8; 7/16; 1/2; 9/16"
	No 40aDL	1/4" sizes 3/16; 7/32; 1/4; 9/32; 5/16; 11/32; 3/8; 7/16; 1/2; 9/16"
	No 402a	1/4" sizes 1/4; 5/16; 3/8; 7/16; 1/2"
	No 405QR/2	1/4" 54 mm
	No 405QR/6	1/4" 150 mm
	No 407QR	1/4" 38 mm
	No 409M	3/8" 1/4"
	No 415QR N	1/4"
	No 415SGB N	1/4"
	No 412	1/4"
	No 45a	3/8" sizes 1/2; 9/16; 19/32; 5/8; 11/16; 3/4; 15/16; 1"
	No 46a	3/8" sizes 5/8; 11/16; 3/4; 7/8"
	No 427QR/3	3/8" 76 mm
	No 427QR/10	3/8" 240 mm
	No 428QR	3/8" 46 mm
	No 431	1/4" 3/8"
	No 432M	1/2" 3/8"
	No 435QR N	3/8"
	No 443	5/16" 3/8"
	No 453	3/8"
	No 4000	
	No 104	120 x 2; 120 x 3; 120 x 4; 120 x 5 mm

	No 109	sizes 2; 5
	No 4622	size 1 (1.0 x 5.5 x 100 mm) size 3 (1.2 x 8.0 x 150 mm)
	No 4632	sizes 1; 2; 3
	No 10767a/13	sizes 0.050; 1/16; 5/64; 3/32; 7/64; 1/8; 9/64; 5/32; 3/16; 7/32; 1/4; 5/16; 3/8"
	No 65 16 5 200	
	No 65 32 5 170	
	No 65 51 6 240	
	No 65 64 2 175	
	No 65 75 1 220	
	No 66 00 5 160	
	No 10956	∅ 35 mm
	No 10960	500 g
	No 11095/20	0.05-1 mm
	No 12053	
	No 12320	
	No 12321	
	No 12600	270 g
	No 12900	
	No 12921N	∅ 50 mm
	No 12922E	∅ 6 mm
	No 12935/3	3 m
	No 13126-1	



→ 11

The STAHLWILLE **Tool trolley 95VA** is equipped with a three-stage safety concept - for maximum safety in the respective application.

13221 WT/TS AOG-Kit for aeroplanes in tool trolley No 13217

TCS

163 Tools,
in TCS inlays
(Tool Control System
see page 53).
Tool Trolley No 13217
and accessories see
pages 17, 18.



Code	⚖️ kg
98 81 49 15	29



96 83 01 33



96 83 01 34



96 83 01 35



96 83 01 36



96 83 01 37

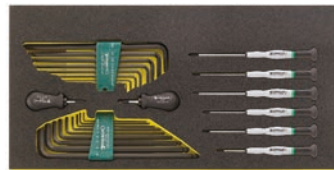

96 83 01 38

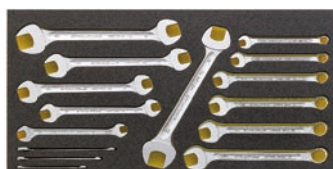

96 83 01 39



96 83 01 40















No 10	sizes 4 x 5; 6 x 7; 8 x 9; 10 x 11; 12 x 13; 14 x 15; 16 x 17; 18 x 21; 19 x 22; 27 x 32 mm
No 13a	sizes 3/8; 7/16; 1/2; 9/16; 5/8; 11/16"
No 17	sizes 8; 9; 10; 11; 12; 13; 14; 15; 16; 17; 18; 19 mm
No 23	sizes 6 x 7; 8 x 9; 10 x 11; 12 x 13; 14 x 15; 16 x 17; 18 x 19; 20 x 22 mm

No 40D	1/4" sizes 5; 6; 7; 8; 9; 10; 11; 12; 13; 14 mm
No 40DL No 40aDL	1/4" sizes 5; 6; 7; 8; 10; 11; 12; 13 mm 1/4" sizes 3/16; 7/32; 1/4; 9/32; 5/16; 11/32; 3/8; 7/16; 1/2; 9/16"
No 405QR/2	1/4" 54 mm
No 405QR/6	1/4" 150 mm
No 407QR	1/4" 45 mm
No 409	3/8" 1/4"
No 412	1/4"
No 415QR N	1/4"
No 415B	1/4"
No 45	3/8" sizes 10; 11; 12; 13; 14; 15; 16; 17; 18; 19 mm
No 45a	3/8" sizes 1/2; 9/16; 19/32; 5/8; 11/16; 3/4; 15/16; 1"
No 427QR/3	3/8" 76 mm
No 427QR/6	3/8" 160 mm
No 428QR	3/8" 46 mm
No 431	1/4" 3/8"
No 435QR N	3/8"
No 3115	1/4"
No 13010	sizes 4; 5; 6; 8; 10
No 4008-1	
No 4622SK	size 1 (0.8 x 4.0 x 90 mm) size 3 (1.2 x 6.5 x 125 mm)
No 4632SK	sizes 1; 2; 3
No 4636	No 4; 8
No 4724	size 2 (1.0 x 5.5 x 25 mm)
No 4744	size 1
No 4751	size 4 (0.3 x 1.5 mm) size 6 (0.4 x 2.0 mm) size 7 (0.4 x 2.5 mm) size 8 (0.5 x 3.0 mm)
No 4752	sizes 0; 1
No 10767H/9	sizes 1.5; 2; 2.5; 3; 4; 5; 6; 8; 10 mm
No 10767a/8	sizes 5/64; 3/32; 1/8; 5/32; 3/16; 7/32; 1/4; 5/16"
No 65 01 5 180	
No 65 18 5 130	
No 65 35 5 200	
No 65 51 5 240	
No 65 71 2 165	
No 65 75 1 220	
No 65 76 5 231	
No 66 07 6 110	
No 90432513	
No 105	120 x 10 mm
No 108	150 x 2.5; 150 x 3; 150 x 4; 150 x 5; 150 x 6 mm
No 10956	∅ 27 mm
No 10960	300 g

Continuation see next page

Factory and workshop equipment, sets of tools

1

	No 11095/20	0.05-1 mm
	No 12320	
	No 12321	
	No 12375	
	No 12600	270 g
	No 12800	
	No 12900N	
	No 12921M	∅ 57 mm
	No 12922E	∅ 6 mm
	No 12935/3	3 m
	No 13110	300 mm
	No 13128	
	No 13130	
	No 13217-3 TS	

13224a WT/TS AOG-Kit for aeroplanes in tool trolley No 13217

TCS QR

154 Tools, in TCS inlays (Tool Control System see page 53). Tool Trolley No 13217 and accessories see pages 17, 18.



Code	Δ	kg
9881 49 10		28.4



96 83 01 10



96 83 01 11



96 83 01 12

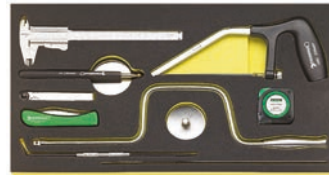

96 83 01 13

































96 83 01 14



























96 83 01 15



96 83 01 16

	No 12a	sizes 5/32; 7/32; 1/4"
	No 13a	sizes 3/16; 13/64; 7/32; 15/64; 1/4; 9/32; 5/16; 11/32; 3/8; 7/16; 1/2; 9/16; 19/32; 5/8; 11/16; 3/4; 25/32; 13/16; 7/8; 15/16; 1; 1 1/16; 1 1/8"
	No 25a	sizes 1/4 x 5/16; 5/16 x 11/32; 3/8 x 7/16; 1/2 x 9/16"
	No 40aD	1/4" ∅ sizes 3/16; 7/32; 1/4; 9/32; 5/16; 11/32; 3/8; 7/16; 1/2; 9/16"
	No 40aDL	1/4" ∅ sizes 3/16; 7/32; 1/4; 9/32; 5/16; 11/32; 3/8; 7/16; 1/2; 9/16"
	No 402a No 402aK	1/4" ∅ sizes 1/4; 5/16; 3/8; 7/16; 1/2" 1/4" ∅ size 9/16"
	No 405W/2	1/4" ■ ∅ 54 mm
	No 405QR/2	1/4" ■ ∅ 54 mm
	No 405QR/6	1/4" ■ ∅ 150 mm
	No 407QR	1/4" ■ ∅ 45 mm
	No 409M	3/8" ■ 1/4" ∅
	No 412	1/4" ∅ ∅
	No 415QR	1/4" ■
	No 415B	1/4" ∅
	No 45a	3/8" ∅ sizes 1/2; 9/16; 19/32; 5/8; 11/16; 3/4; 15/16; 1"
	No 46a	3/8" ∅ sizes 5/8; 11/16; 3/4; 7/8"
	No 427W/3	1/4" ■ ∅ 76 mm
	No 427QR/3	3/8" ■ ∅ 76 mm
	No 427QR/10	3/8" ■ ∅ 240 mm
	No 428QR	3/8" ■ ∅ 46 mm
	No 431	1/4" ■ 3/8" ∅
	No 432M	1/2" ■ 3/8" ∅
	No 435QR N	3/8" ■
	No 443	5/16" ∅ 3/8" ∅
	No 453	3/8" ■
	No 1204/21-1	4 x ⊕; 4 x ⊕; 9 x ⊕; 3 x ⊕
	No 4000	
	No 4622SK	size 1 (0.8 x 4.0 x 90 mm) size 3 (1.2 x 6.5 x 125 mm)
	No 4632SK	sizes 1; 2; 3
	No 4724	size 2 (1.0 x 5.5 x 25 mm)
	No 4734	size 2

	No 10767a/13	sizes 0.050; 1/16; 5/64; 3/32; 7/64; 1/8; 9/64; 5/32; 3/16; 7/32; 1/4; 5/16; 3/8"
	No 65 16 5 200	
	No 65 32 5 170	
	No 65 64 2 175	
	No 65 72 6 240	
	No 65 75 1 220	
	No 65 76 5 231	
	No 66 00 5 160	
	No 104	120 x 2; 120 x 3; 120 x 4; 120 x 5 mm
	No 109	sizes 2; 5
	No 10956	∅ 27 mm
	No 10960	300 g

	No 11095/20	0.05-1 mm
	No 12053	
	No 12320	
	No 12321	
	No 12600	270 g
	No 12800	
	No 12900N	
	No 12921M	∅ 57 mm
	No 12922E	∅ 6 mm
	No 12935/3	3 m
	No 13110	300 mm
	No 13126-1	
	No 13217-2 TS	



1



The modular tool tray system. **Standard – the perfectly organised workshop.**

Tool trays from STAHLWILLE ensure perfect tool management within the Tool Trolley or Tool Box. All the tools are neatly arranged and instantly at hand, and always securely held in the same place. The Tool Trolley or Tool Box can be equipped as required with 1/6, 1/3, 2/3 or 3/3 inlays.

Wherever large numbers of tools are in constant use and rapid, unhindered access is paramount, the inlays in this tried-and-tested modular STAHLWILLE system provide the security and efficiency required for smooth workflows and reliable quality. The drawers of the Tool Trolleys can be optimally used if a number of spare inlays are kept in store to enable the perfect “for task” combination of tools. In addition, these inlays are made of skydrol resistant and permanently oil resistant engineering plastic and the sculpted cut-outs protect your high-grade, expensive tools.



The perfectly organised workshop

Tool sets in plastic inlays for Workbench No WB620, Tool trolleys No 90, 95, 95VA, 98VA; Magazine case No 920 and Wheely box No 922N (Modular system)

806/10 Tool set

99 Tools, in plastic inlays (modular system see page 42-52), 9x1/3 and 1x3/3 inlays for 4 drawers (No 98VA for 2 drawers), suitable for Workbench No WB620, Tool trolleys No 90, 95, 95VA, 98VA, Magazine case No 920 and Wheely box No 922N

Code	kg
98 83 0001	13.35

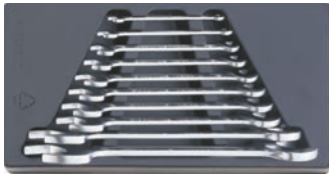

96 83 81 26



96 83 81 27



96 83 81 28



96 83 81 10



96 83 81 12



96 83 81 13



96 83 82 37



96 83 81 21



96 83 81 23



96 83 81 25

No 10	sizes 6 x 7; 8 x 9; 10 x 11; 12 x 13; 14 x 15; 16 x 17; 18 x 19; 20 x 22; 24 x 27; 30 x 32 mm
No 13	sizes 6; 7; 8; 9; 10; 11; 12; 13; 14; 15; 16; 17; 18; 19; 20; 21; 22; 24 mm
No 40	1/4" sizes 5.5; 6; 7; 8; 9; 10; 11; 12; 13; 14 mm

No 400	1/4" 150 mm
No 404	1/4" 116 mm
No 405/2	1/4" 54 mm
No 405/6	1/4" 150 mm
No 407	1/4" 38 mm
No 412	1/4"
No 415	1/4"
No 10760CV	sizes 1.5; 2; 2.5; 3; 4; 5; 6; 8; 10; 12 mm
No 52	1/2" sizes 10; 11; 12; 13; 14; 15; 16; 17; 18; 19; 20; 21; 22; 24; 27; 30; 32 mm
No 506	1/2" 300 mm
No 509/2	1/2" 52 mm
No 509/5	1/2" 130 mm
No 509/10	1/2" 255 mm
No 510	1/2" 71 mm
No 512	1/2"
No 4620	size 1 (0.6 x 3.5 x 75 mm) size 2 (0.8 x 4.0 x 100 mm) size 3 (1.0 x 5.5 x 125 mm) size 4 (1.2 x 6.5 x 150 mm) size 5 (1.6 x 8.0 x 175 mm)
No 4630	sizes 1; 2; 3
No 65 01 5 180	
No 65 29 5 200	
No 65 43 4 002	
No 65 45 4 002	
No 65 51 6 240	
No 65 64 2 250	
No 66 02 5 160	
No 102	175 mm
No 108	150 x 6; 175 x 6 mm
No 109	size 6; 100 x 3.4 mm
No 10956	∅ 35 mm
No 10960	500 g

Made in Germany

Factory and workshop equipment, sets of tools

1

808/9 Tool set

102 Tools, in plastic inlays (modular system see page 42-52), 9x1/3 and 1x3/3 inlays for 4 drawers (No 98VA for 2 drawers), suitable for Workbench No WB620, Tool trolleys No 90, 95, 95VA, 98VA; Magazine case No 920 and Wheely box No 922N.

Code	♻️ kg
98 83 00 02	11.7



96 83 81 30

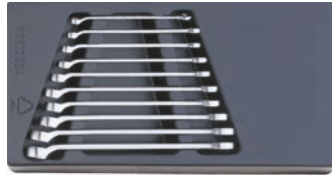

96 83 81 05



96 83 81 06



96 83 81 10



96 83 81 11



96 83 82 38



96 83 81 32



96 83 81 24



96 83 81 31

	No 10	sizes 5.5 x 7; 8 x 10; 10 x 12; 11 x 13; 12 x 14; 14 x 17; 17 x 19; 18 x 21; 19 x 22; 22 x 24 mm
	No 14	sizes 6; 7; 8; 9; 10; 11; 12; 13; 14; 15; 16; 17; 18; 19; 20; 21; 22; 24 mm
	No 40	1/4" \bigcirc sizes 5.5; 6; 7; 8; 9; 10; 11; 12; 13; 14 mm
	No 400	1/4" \blacksquare 150 mm
	No 404	1/4" \blacksquare 116 mm
	No 405/2	1/4" \blacksquare \bigcirc 54 mm
	No 405/6	1/4" \blacksquare \bigcirc 150 mm
	No 407	1/4" \blacksquare \bigcirc 38 mm
	No 412	1/4" \bigcirc \bigcirc
	No 415	1/4" \blacksquare
	No 10760CV	sizes 1.5; 2; 2.5; 3; 4; 5; 6; 8; 10; 12 mm
	No 456	3/8" \bigcirc sizes 7; 8; 9; 10; 11; 12; 13; 14; 15; 16; 17; 18; 19; 20; 21; 22 mm

	No 425	3/8" \blacksquare 165 mm
	No 427/3	3/8" \blacksquare \bigcirc 76 mm
	No 427/6	3/8" \blacksquare \bigcirc 160 mm
	No 427/10	3/8" \blacksquare \bigcirc 240 mm
	No 428	3/8" \blacksquare \bigcirc 46 mm
	No 435	3/8" \blacksquare
	No 4620	size 1 (0.6 x 3.5 x 75 mm) size 2 (0.8 x 4.0 x 100 mm)
	No 4622	size 1 (1.0 x 5.5 x 100 mm) size 2 (1.2 x 6.5 x 125 mm) size 3 (1.2 x 8.0 x 150 mm)
	No 4632	sizes 1; 2; 3
	No 65 01 5 200	
	No 65 29 5 160	
	No 65 43 4 002	
	No 65 45 4 002	
	No 65 51 6 240	
	No 65 64 2 250	
	No 66 02 5 160	
	No 102	175 mm
	No 105	120 x 12 mm
	No 108	150 x 2.5; 150 x 3; 150 x 4; 150 x 5; 150 x 6; 150 x 8 mm
	No 10956	\varnothing 35 mm
	No 10970	1 lb.

The modular tool tray system

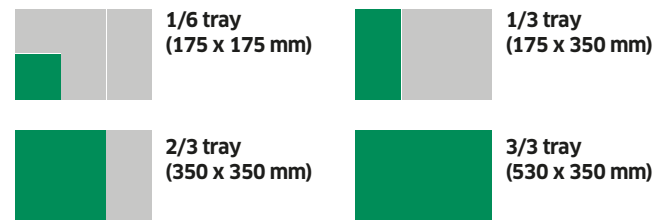

ES 10/10, 5.5x7-22x24 mm



175 x 350 x 60 mm, 10 pieces

Code	g
96 83 81 30	1100
No 10	sizes 5.5 x 7; 8 x 10; 10 x 12; 11 x 13; 12 x 14; 14 x 17; 17 x 19; 18 x 21; 19 x 22; 22 x 24 mm
83 81 20 33 Empty tray	106

ES 13/5, 27-32 mm



530 x 350 x 30 mm, 5 pieces

Code	g
96 83 81 04	2280
No 13	sizes 27; 28; 29; 30; 32 mm
83 81 20 40 Empty tray	287

ES 10/10, 6x7-30x32 mm

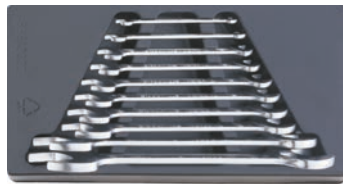

175 x 350 x 70 mm, 10 pieces

Code	g
96 83 81 26	1515
No 10	sizes 6 x 7; 8 x 9; 10 x 11; 12 x 13; 14 x 15; 16 x 17; 18 x 19; 20 x 22; 24 x 27; 30 x 32 mm
83 81 20 22 Empty tray	112

ES 14/10, 6-15 mm

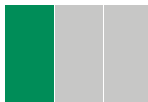

175 x 350 x 39 mm, 10 pieces

Code	g
96 83 81 05	700
No 14	sizes 6; 7; 8; 9; 10; 11; 12; 13; 14; 15 mm
83 81 20 34 Empty tray	110

ES 13/10, 6-15 mm



175 x 350 x 40 mm, 10 pieces

Code	g
96 83 81 27	525
No 13	sizes 6; 7; 8; 9; 10; 11; 12; 13; 14; 15 mm
83 81 20 23 Empty tray	105

ES 14/8, 16-24 mm



175 x 350 x 51 mm, 8 pieces

Code	g
96 83 81 06	1820
No 14	sizes 16; 17; 18; 19; 20; 21; 22; 24 mm
83 81 20 35 Empty tray	112

ES 13/8, 16-24 mm



175 x 350 x 54 mm, 8 pieces

Code	g
96 83 81 28	1440
No 13	sizes 16; 17; 18; 19; 20; 21; 22; 24 mm
83 81 20 24 Empty tray	112

ES 20/8, 6x7-19x22 mm



175 x 350 x 30 mm, 8 pieces

Code	g
96 83 81 67	1266
No 20	sizes 6 x 7; 8 x 9; 10 x 11; 12 x 13; 14 x 15; 16 x 17; 18 x 21; 19 x 22 mm
83 81 20 83 Empty tray	103

Factory and workshop equipment, sets of tools

1

ES 20/10, 6x7-30x32 mm



530 x 350 x 44 mm, 10 pieces

Code	Δ	g
96838107		2620

No 20	sizes 6 x 7; 8 x 9; 10 x 11; 12 x 13; 14 x 15; 16 x 17; 18 x 19; 20 x 22; 24 x 27; 30 x 32 mm
--------------	---

83812044 Empty tray	309
----------------------------	-----

ES 24/7, 8x10-19x22 mm



175 x 350 x 30 mm, 7 pieces

Code	Δ	g
96838171		835

No 24	sizes 8 x 10; 10 x 11; 11 x 13; 12 x 14; 14 x 17; 17 x 19; 19 x 22 mm
--------------	---

83812086 Empty tray	103
----------------------------	-----

ES 25/7, 7x8-17x19 mm



175 x 350 x 30 mm, 7 pieces

Code	Δ	g
96838108		1040

No 25	sizes 7 x 8; 9 x 10; 10 x 11; 12 x 13; 14 x 15; 16 x 18; 17 x 19 mm
--------------	---

83812038 Empty tray	111
----------------------------	-----

ES 29/6, 8x9-18x19 mm



175 x 350 x 30 mm, 6 pieces

Code	Δ	g
96838109		1185

No 29	sizes 8 x 9; 10 x 11; 12 x 13; 14 x 15; 16 x 17; 18 x 19 mm
--------------	---

83812041 Empty tray	105
----------------------------	-----

ES 10750/10, 6x7-20x22 mm

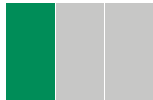

175 x 350 x 30 mm, 10 pieces

Code	Δ	g
96838168		1132

No 10750	sizes 6 x 7; 8 x 9; 10 x 11; 12 x 13; 14 x 15; 16 x 17; 18 x 19; 20 x 22 mm
-----------------	---

No 10750 1/2	sizes 6; 7
---------------------	------------

83812084 Empty tray	103
----------------------------	-----

ES TX/32

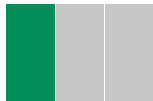

175 x 350 x 40 mm, 32 pieces

Code	Δ	g
96838166		931

No 21TX	sizes E6 x E8; E10 x E12; E14 x E18; E20 x E24
----------------	--

No 45TX	3/8" sizes E8; E10; E12; E14
----------------	-------------------------------

No 50TX	1/2" sizes E16; E18; E20
----------------	---------------------------

No 412	1/4"
---------------	------

No 442	1/4"
---------------	------

No 543	5/16"
---------------	-------

No 1440	size T10
No 1441	size T15
No 1442	size T20
No 1443	size T25
No 1444	size T27
No 1445	size T30

No 1432	size T40
No 1433	size T45
No 1434	size T50

No 10766/9	sizes T8; T9; T10; T15; T20; T25; T27; T30; T40
-------------------	---

83812082 Empty tray	103
----------------------------	-----



ES 1/4" + 10760CV

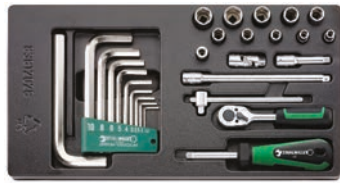

175 x 350 x 41 mm, 27 pieces

Code		Δ	g
96838110		1035	
No 40	1/4" ○ sizes 5.5; 6; 7; 8; 9; 10; 11; 12; 13; 14 mm		
No 400	1/4" ■ 150 mm		
No 404	1/4" ■ 116 mm		
No 405/2	1/4" ■ ○ 54 mm		
No 405/6	1/4" ■ ○ 150 mm		
No 407	1/4" ■ ○ 38 mm		
No 412	1/4" ○ ○		
No 415	1/4" ■		
No 10760CV	sizes 1.5; 2; 2.5; 3; 4; 5; 6; 8; 10; 12 mm		
83812028	Empty tray	107	

ES 456/16/6

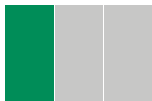

175 x 350 x 40 mm, 22 pieces

Code		Δ	g
96838111		1555	
No 456	3/8" ○ sizes 7; 8; 9; 10; 11; 12; 13; 14; 15; 16; 17; 18; 19; 20; 21; 22 mm		
No 425	3/8" ■ 165 mm		
No 427/3	3/8" ■ ○ 76 mm		
No 427/6	3/8" ■ ○ 160 mm		
No 427/10	3/8" ■ ○ 240 mm		
No 428	3/8" ■ ○ 46 mm		
No 435	3/8" ■		
83812032	Empty tray	103	

ES 52/17



175 x 350 x 47 mm, 17 pieces

Code		Δ	g
96838112		1760	
No 52	1/2" ○ sizes 10; 11; 12; 13; 14; 15; 16; 17; 18; 19; 20; 21; 22; 24; 27; 30; 32 mm		
83812030	Empty tray	107	

ES 1/2" - 512/6



175 x 350 x 35 mm, 6 pieces

Code		Δ	g
96838113		1915	
No 506	1/2" ■ 300 mm		
No 509/2	1/2" ■ ○ 52 mm		
No 509/5	1/2" ■ ○ 130 mm		
No 509/10	1/2" ■ ○ 255 mm		
No 510	1/2" ■ ○ 71 mm		
No 512	1/2" ■		
83812029	Empty tray	110	

ES 54/54KK



175 x 350 x 38 mm, 14 pieces

Code		Δ	g
96838114		1630	
No 54	1/2" ○ sizes 4; 5; 6; 7; 8; 10; 12; 14; 17; 19 mm		
No 54KK	1/2" ○ sizes 5; 6; 8; 10 mm		
83812046	Empty tray	108	

ES 54KK/5



175 x 175 x 30 mm, 5 pieces

Code		Δ	g
96838165		505	
No 54KK	1/2" ○ sizes 5; 6; 7; 8; 10 mm		
83812051	Empty tray	55	

Factory and workshop equipment, sets of tools

1

ES 1054/2054



175 x 175 x 30 mm, 6 pieces

Code	⚠ g	
96838164	900	
No 1054	1/2" ⌀ sizes 8; 10; 12 mm	
No 2054	1/2" ⌀ sizes 5; 6; 14 mm	
83812081 Empty tray	55	

ES 54X/54TX



175 x 350 x 38 mm, 16 pieces

Code	⚠ g	
96838115	1600	
No 54X	1/2" ⌀ sizes M5; M6; M8; M10; M12; M14; M16	
No 54TX	1/2" ⌀ sizes T20; T25; T27; T30; T40; T45; T50; T55; T60	
83812045 Empty tray	111	

ES 1054/2054TX/6

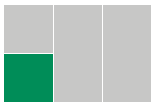

175 x 175 x 30 mm, 6 pieces

Code	⚠ g	
96838163	950	
No 1054TX	1/2" ⌀ sizes T30; T50; T55; T60	
No 2054TX	1/2" ⌀ sizes T40; T45	
83812081 Empty tray	55	

ES 55/6/4



530 x 350 x 83 mm, 10 pieces

Code	⚠ g	
96838174	7875	
No 55	3/4" ⌀ sizes 34; 36; 41; 46; 50; 55 mm	
No 552	3/4" ■	
No 556	3/4" ■	
No 558	510 mm	
No 559/8	3/4" ■ ⌀ 200 mm	
83812089 Empty tray	298	

ES 2309/4



175 x 175 x 40 mm, 4 pieces

Code	⚠ g	
96838162	1145	
No 2309	1/2" ⌀ sizes 17; 19; 21; 22 mm	
83812080 Empty tray	55	

ES 2309K/3



175 x 175 x 40 mm, 3 pieces

Code	⚠ g	
96838260	800	
No 2309K	1/2" ⌀ sizes 17; 19; 21 mm	
83812080 Empty tray	55	

STAHLWILLE »AS-Drive«



STAHLWILLE sockets are equipped with the AS Drive* profile: this permits high transmission of forces to the lands of nuts and bolts without damaging them. No longer will you have to worry about stripping the corners off nuts and bolts.

*Anti-Slip-Drive



ES 721/15/3/2



530 x 350 x 40 mm, 6 pieces

Code	g
96 83 81 72	5060



No 2309K 1/2" \square sizes 17; 19; 21 mm



No 721/15 Quick 30-150 N·m



No 35c cars 17; 19; 22; \blacksquare 1/2"



No 10599/2 245 mm

83 81 20 87 Empty tray	299
-------------------------------	-----

ES 4620/4628/4630/7

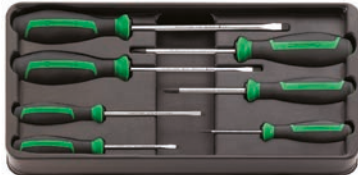

175 x 350 x 39 mm, 7 pieces

Code	g
96 83 82 36	530



No 4620 size 1 (0.6 x 3.5 x 75 mm)
size 2 (0.8 x 4.0 x 100 mm)
size 3 (1.0 x 5.5 x 125 mm)
size 4 (1.2 x 6.5 x 150 mm)



No 4628 size 1 (0.4 x 2.5 x 60 mm)



No 4630 sizes 1; 2

83 81 21 01 Empty tray	98
-------------------------------	----

ES 4620/4630/8

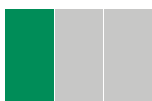

175 x 350 x 39 mm, 8 pieces

Code	g
96 83 82 37	770



No 4620 size 1 (0.6 x 3.5 x 75 mm)
size 2 (0.8 x 4.0 x 100 mm)
size 3 (1.0 x 5.5 x 125 mm)
size 4 (1.2 x 6.5 x 150 mm)
size 5 (1.6 x 8.0 x 175 mm)



No 4630 sizes 1; 2; 3

83 81 21 02 Empty tray	111
-------------------------------	-----

ES 4620/4622/4632/8



175 x 350 x 39 mm, 8 pieces

Code	g
96 83 82 38	770



No 4620 size 1 (0.6 x 3.5 x 75 mm)
size 2 (0.8 x 4.0 x 100 mm)



No 4622 size 1 (1.0 x 5.5 x 100 mm)
size 2 (1.2 x 6.5 x 125 mm)
size 3 (1.2 x 8.0 x 150 mm)



No 4632 sizes 1; 2; 3

83 81 21 02 Empty tray	111
-------------------------------	-----

ES 4622-4734/9



175 x 350 x 39 mm, 9 pieces

Code	g
96 83 82 34	865



No 4622 size 1 (1.0 x 5.5 x 100 mm)
size 2 (1.2 x 6.5 x 125 mm)
size 3 (1.2 x 8.0 x 150 mm)
size 4 (1.6 x 10.0 x 175 mm)



No 4628 size 1 (0.4 x 2.5 x 60 mm)



No 4632 sizes 1; 2



No 4724 size 2 (1.0 x 5.5 x 25 mm)



No 4734 size 2

83 81 21 03 Empty tray	100
-------------------------------	-----

ES 4622SK/4632SK/6



175 x 350 x 39 mm, 6 pieces

Code	g
96 83 82 19	770



No 4622SK size 1 (0.8 x 4.0 x 90 mm)
size 2 (1.0 x 5.5 x 100 mm)
size 3 (1.2 x 6.5 x 125 mm)
size 4 (1.2 x 8.0 x 150 mm)



No 4632SK sizes 1; 2

83 81 21 06 Empty tray	111
-------------------------------	-----

Factory and workshop equipment, sets of tools

1

ES 4650/9

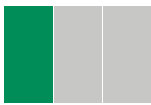

175 x 350 x 39 mm, 9 pieces

Code	⚠ g
96838217	645
No 4650	sizes T8; T9; T10; T15; T20; T25; T27; T30; T40
83812104 Empty tray	100

ES 4656/9

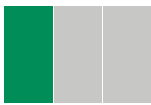

175 x 350 x 39 mm, 9 pieces

Code	⚠ g
96838218	645
No 4656	sizes T8; T9; T10; T15; T20; T25; T27; T30; T40
83812104 Empty tray	100

ES 4660/4665 VDE/6

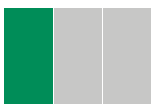

175 x 350 x 39 mm, 6 pieces

Code	⚠ g
96838235	525
No 4660 VDE	size 1 (0.4 x 2.5 x 75 mm) size 3 (0.6 x 3.5 x 100 mm) size 5 (1.0 x 5.5 x 125 mm) size 6 (1.2 x 6.5 x 150 mm)
No 4665 VDE	sizes 1; 2
83812105 Empty tray	99

ES 4820/4830/6

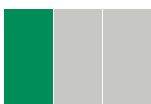

175 x 350 x 33 mm, 6 pieces

Code	⚠ g
96838134	480
Nr. 4820	0.6 x 3.5 x 75 mm 0.8 x 4.0 x 100 mm 1.0 x 5.5 x 125 mm 1.2 x 6.5 x 150 mm
Nr. 4830	sizes 1; 2
83812066 Empty tray	111

ES 4820/4830/8



175 x 350 x 30 mm, 8 pieces

Code	⚠ g
96838135	735
No 4820	0.6 x 3.5 x 75 mm 0.8 x 4.0 x 100 mm 1.0 x 5.5 x 125 mm 1.2 x 6.5 x 150 mm 1.6 x 8.0 x 175 mm
No 4830	sizes 1; 2; 3
83812068 Empty tray	110

ES 4856/9



175 x 350 x 30 mm, 9 pieces

Code	⚠ g
96838136	705
No 4856	sizes T8; T9; T10; T15; T20; T25; T27; T30; T40
83812067 Empty tray	110

ES 12500N/7



175 x 350 x 39 mm, 7 pieces

Code	⚠ g
96838300	1060
No 12500N	sizes 7; 8; 9; 10; 11; 12; 13 mm
83813085 Empty tray	103

ES 10768/6



350 x 350 x 37 mm, 6 pieces

Code	⚠ g
96838119	780
No 10768	sizes 3; 4; 5; 6; 8; 10 mm
83812042 Empty tray	209

ES 10769/7



175 x 350 x 35 mm, 7 pieces

Code	Δ∇ g
96 83 81 20	450

No 10769	sizes T10; T15; T20; T25; T27; T30; T40
83 81 20 43	Empty tray 116

ES 10769B/7

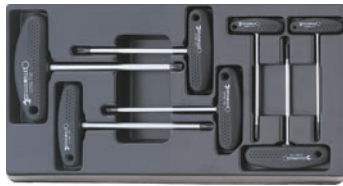

175 x 350 x 35 mm, 7 pieces

Code	Δ∇ g
96 83 81 29	450

No 10769B	sizes T10; T15; T20; T25; T27; T30; T40
83 81 20 43	Empty tray 116

ES 6501-6602/7A



530 x 350 x 40 mm, 7 pieces

Code	Δ∇ g
96 83 81 21	2085

No 65 01 5 180	
No 65 29 5 200	
No 65 43 4 002	
No 65 45 4 002	
No 65 51 6 240	
No 65 64 2 250	
No 66 02 5 160	
83 81 20 21	Empty tray 307

ES 6501-6602/7B



530 x 350 x 40 mm, 7 pieces

Code	Δ∇ g
96 83 81 32	2055

No 65 01 5 200	
No 65 29 5 160	
No 65 43 4 002	
No 65 45 4 002	
No 65 51 6 240	
No 65 64 2 250	
No 66 02 5 160	
83 81 20 21	Empty tray 307

ES 6543-6546/4

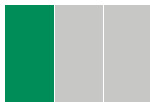

175 x 350 x 30 mm, 4 pieces

Code	Δ∇ g
96 83 81 22	700

No 65 43 4 002	
No 65 44 4 021	
No 65 45 4 002	
No 65 46 4 021	
83 81 20 37	Empty tray 109

ES 102/108/109/4



175 x 350 x 30 mm, 4 pieces

Code	Δ∇ g
96 83 81 23	555

No 102	175 mm
No 108	150 x 6; 175 x 6 mm
No 109	size 6; 100 x 3.4 mm
83 81 20 27	Empty tray 115

Factory and workshop equipment, sets of tools

1

ES 102/105/108/8



175 x 350 x 33 mm, 8 pieces

Code		♻️ g
96838124		900
No 102	175 mm	
No 105	120 x 12 mm	
No 108	150 x 2.5; 150 x 3; 150 x 4; 150 x 5; 150 x 6; 150 x 8 mm	
83812036	Empty tray	114

ES 10670-13110/11



530 x 350 x 35 mm, 11 pieces

Code		♻️ g
96838173		2120
No 10670	265 mm	
No 12025	210 mm	
No 12030	260 mm	
No 12035	210 mm	
No 12036	260 mm	
No 12050	465 mm	
No 12320		
No 12321		
No 12377		
No 12935/3	3 m	
No 13110	300 mm	
83812088	Empty tray	301

ES 10956/10960/2



175 x 350 x 45 mm, 2 pieces

Code		♻️ g
96838125		1130
No 10956	∅ 35 mm	
No 10960	500 g	
83812025	Empty tray	114

ES 10956/10970/2



175 x 350 x 45 mm, 2 pieces

Code		♻️ g
96838131		1075
No 10956	∅ 35 mm	
No 10970	1 lb.	
83812025	Empty tray	114

Empty inlay



175 x 350 x 30 mm

Code		♻️ g
83812047		110

Empty inlay



175 x 175 x 28 mm

Code		♻️ g
83812080		55

The modular tool tray system



1/6 tray
(175 x 175 mm)



1/3 tray
(175 x 350 mm)



2/3 tray
(350 x 350 mm)



3/3 tray
(530 x 350 mm)



The modular tool tray system.

Tool Control System – built-in safety.

1



Initially, the TCS Tool Control System was developed by STAHLWILLE in conjunction with British Aerospace for the aerospace industry with a view to improving safety. Today, the system is appreciated by employees in the automotive industry and other fields of industry and the trades for its convincing benefits. The system guarantees a high level of organisation and security, protects high-grade, expensive tools from damage and is ideal wherever large numbers of tools are prone to “disappear” – in other words, a real value-for-money investment that will soon pay for itself.



The advantages at a glance:

- With our Tool Control System, the tools are arranged in chemical-resistant special foam inlays with milled three-dimensional cut-outs.
- The signal colour is yellow. A glance is enough to see whether all tools are in their correct places: if you can see yellow, there is something missing.



1 The milled cut-outs for each tool are individually shaped using computer technology to provide each tool with a secure place. Easy to remove thanks to additional recesses.

2 The milled cut-outs enable you to see at a glance where each tool goes. Saves time and money.

3 The inlays are chemical-resistant and extremely flexible.

4 Two-layer, two-colour plastic inlays: the upper half is black and the lower layer is yellow.

Tool sets in TCS inlays for Workbench No WB620, Tool trolleys No 90, 95, 95VA, 98VA; Magazine case No 920 and Wheely box No 922N

806/9 TCS TCS tool set



98 Tools, in TCS inlays (Tool Control System see page 53-71), 7x1/3, 1x2/3 and 1x3/3 inlays for 4 drawers (No 98VA for 2 drawers), suitable for Workbench No WB620, Tool trolleys No 90, 95, 95VA, 98VA; Magazine case No 920 and Wheely box No 922N.

Code	⚖️ kg
98 83 00 04	12.53



96 83 81 75

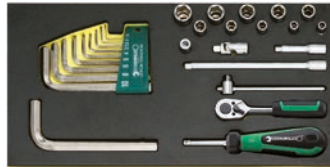

96 83 81 76



96 83 81 77



96 83 82 78

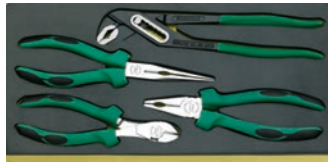

96 83 81 79



96 83 81 80



96 83 81 81



96 83 81 82



96 83 81 83

	No 10	sizes 6 x 7; 8 x 9; 10 x 11; 12 x 13; 14 x 15; 16 x 17; 18 x 19; 20 x 22; 24 x 27; 30 x 32 mm
	No 13	sizes 6; 7; 8; 9; 10; 11; 12; 13; 14; 15; 16; 17; 18; 19; 20; 21; 22; 24 mm
	No 40	1/4" ⚪ sizes 5.5; 6; 7; 8; 9; 10; 11; 12; 13; 14 mm
	No 400	1/4" ■ 150 mm

	No 404	1/4" ■ 116 mm
	No 405/2	1/4" ■ ⚪ 54 mm
	No 405/6	1/4" ■ ⚪ 150 mm
	No 407	1/4" ■ ⚪ 38 mm
	No 412	1/4" ⚪ ⚪
	No 415	1/4" ■
	No 10760CV	sizes 1.5; 2; 2.5; 3; 4; 5; 6; 8; 10; 12 mm
	No 52	1/2" ⚪ sizes 10; 11; 12; 13; 14; 15; 16; 17; 18; 19; 20; 21; 22; 24; 27; 30; 32 mm
	No 506	1/2" ■ 300 mm
	No 509/2	1/2" ■ ⚪ 52 mm
	No 509/5	1/2" ■ ⚪ 130 mm
	No 509/10	1/2" ■ ⚪ 255 mm
	No 510	1/2" ■ ⚪ 71 mm
	No 512	1/2" ■
	No 4620	size 1 (0.6 x 3.5 x 75 mm) size 2 (0.8 x 4.0 x 100 mm) size 3 (1.0 x 5.5 x 125 mm) size 4 (1.2 x 6.5 x 150 mm)
	No 4630	sizes 1; 2; 3
	No 65 01 5 180	
	No 65 29 5 200	
	No 65 43 4 002	
	No 65 45 4 002	
	No 65 51 6 240	
	No 65 64 2 250	
	No 66 02 5 160	
	No 102	175 mm
	No 108	150 x 6; 175 x 6 mm
	No 109	size 6; 100 x 3.4 mm
	No 10956	∅ 35 mm
	No 10960	500 g



→ 11

STAHLWILLE's **Tool Trolley 95VA** now features even better safety and more sophisticated details.

TCS 10/10, 6x7-30x32 mm



TCS



350 x 350 x 30 mm, 10 pieces

Code	Δ∇ g
96838182	1550



No 10

sizes 6 x 7; 8 x 9; 10 x 11; 12 x 13;
14 x 15; 16 x 17; 18 x 19; 20 x 22;
24 x 27; 30 x 32 mm

TCS 10/10, 6x7-30x32 mm MF

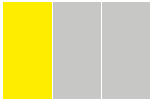

TCS



175 x 350 x 75 mm, 10 pieces

Code	Δ∇ g
96830353	1437



No 10

sizes 6 x 7; 8 x 9; 10 x 11; 12 x 13;
14 x 15; 16 x 17; 18 x 21; 19 x 22;
24 x 27; 30 x 32 mm

TCS 10/10, 6x7-24x27 mm

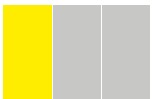

TCS



175 x 350 x 66 mm, 10 pieces

Code	Δ∇ g
96838187	1287



No 10

sizes 6 x 7; 8 x 9; 10 x 11; 12 x 13;
14 x 15; 16 x 17; 18 x 19; 20 x 22;
21 x 24; 24 x 27 mm

TCS 10/10, 6x7-24x27 mm MF

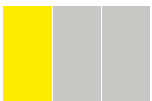

TCS



175 x 350 x 70 mm, 10 pieces

Code	Δ∇ g
96830358	1320



No 10

sizes 6 x 7; 8 x 9; 10 x 11; 12 x 13;
14 x 15; 16 x 17; 18 x 19; 20 x 22;
21 x 24; 24 x 27 mm

TCS 10/11, 6x7-34x36 mm

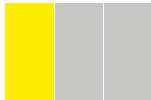

TCS



175 x 350 x 82 mm, 11 pieces

Code	Δ∇ g
96830167	2056



No 10

sizes 6 x 7; 8 x 9; 10 x 11; 12 x 13;
14 x 15; 16 x 17; 18 x 21; 19 x 22;
24 x 27; 30 x 32; 34 x 36 mm

TCS 10+13+24/30



TCS



530 x 350 x 75 mm, 30 pieces

Code	Δ∇ g
96830605	3724



No 10

sizes 6 x 7; 8 x 9; 10 x 11; 12 x 13;
14 x 15; 16 x 17; 18 x 19; 20 x 22;
21 x 24 mm



No 13

sizes 6; 7; 8; 9; 10; 11; 12; 13; 14; 15; 16;
17; 18; 19; 21; 22; 24; 27; 30; 32 mm



No 24

size 10 x 11 mm

TCS 10a/9

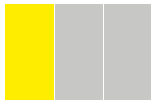

TCS



175 x 350 x 70 mm, 9 pieces

Code	Δ∇ g
96838779	1555



No 10a

sizes 1/4 x 5/16; 3/8 x 7/16; 1/2 x 9/16;
19/32 x 11/16; 5/8 x 3/4; 3/4 x 7/8;
25/32 x 13/16; 15/16 x 1; 1 1/8 x 1 5/16"

TCS 13/18, 6-24 mm



TCS



530 x 350 x 35 mm, 18 pieces

Code	Δ∇ g
96838183	1850



No 13

sizes 6; 7; 8; 9; 10; 11; 12; 13; 14; 15;
16; 17; 18; 19; 20; 21; 22; 24 mm

1

TCS 13/17, 6-24 mm



TCS



350 x 350 x 60 mm, 17 pieces

Code	Δ	g
96830164		1615
No 13	sizes 6; 7; 8; 9; 10; 11; 12; 13; 14; 15; 16; 17; 18; 19; 21; 22; 24 mm	

TCS 13/17, 6-24 mm MF



TCS



350 x 350 x 60 mm, 17 pieces

Code	Δ	g
96830351		1552
No 13	sizes 6; 7; 8; 9; 10; 11; 12; 13; 14; 15; 16; 17; 18; 19; 21; 22; 24 mm	

TCS 13/21, 6-34 mm



TCS



530 x 350 x 75 mm, 21 pieces

Code	Δ	g
96830174		3571
No 13	sizes 6; 7; 8; 9; 10; 11; 12; 13; 14; 15; 16; 17; 18; 19; 21; 22; 24; 27; 30; 32; 34 mm	

TCS 13/25, 5.5-34 mm



TCS



530 x 350 x 80 mm, 25 pieces

Code	Δ	g
96832096		4550
No 13	sizes 5.5; 6; 7; 8; 9; 10; 11; 12; 13; 14; 15; 16; 17; 18; 19; 20; 21; 22; 23; 24; 27; 29; 30; 32; 34 mm	

TCS 12+13+14/29



TCS



530 x 350 x 80 mm, 29 pieces

Code	Δ	g
96830193		3752
No 12	sizes 5.5; 12; 14 mm (2x)	
No 13	sizes 7; 11 mm (2x); sizes 6; 8; 9; 10; 12; 13; 14; 15; 16; 17; 18; 19; 20; 22; 24; 30; 32; 36 mm (1x)	
No 14	size 17 mm	

TCS 13a/19



TCS



350 x 350 x 55 mm, 19 pieces

Code	Δ	g
96838778		2000
No 13a	sizes 3/16; 7/32; 1/4; 9/32; 5/16; 11/32; 3/8; 7/16; 1/2; 9/16; 19/32; 5/8; 11/16; 3/4; 25/32; 13/16; 7/8; 15/16; 1"	

TCS 13a/23



TCS



530 x 350 x 35 mm, 23 pieces

Code	Δ	g
96830885		2726
No 13a	sizes 3/16; 13/64; 7/32; 15/64; 1/4; 9/32; 5/16; 11/32; 3/8; 7/16; 1/2; 9/16; 19/32; 5/8; 11/16; 3/4; 25/32; 13/16; 7/8; 15/16; 1; 1 1/16; 1 1/8"	



TCS 14/5, 17-21 mm

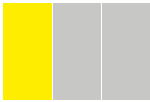

TCS



175 x 350 x 30 mm, 5 pieces

Code	$\Delta \nabla$ g
96 83 81 88	1065

No 14 sizes 17; 18; 19; 20; 21 mm

TCS 20/8, 6x7-19x22 mm



TCS

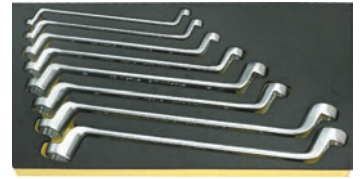

175 x 350 x 45 mm, 8 pieces

Code	$\Delta \nabla$ g
96 83 81 92	1300

No 20 sizes 6 x 7; 8 x 9; 10 x 11; 12 x 13; 14 x 15; 16 x 17; 18 x 21; 19 x 22 mm

TCS 14/8, 8-16 mm

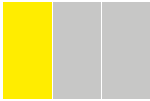

TCS

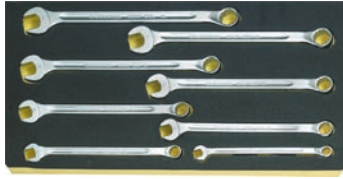

175 x 350 x 30 mm, 8 pieces

Code	$\Delta \nabla$ g
96 83 81 89	660

No 14 sizes 8; 10; 11; 12; 13; 14; 15; 16 mm

TCS 20/8, 6x7-19x22 mm MF

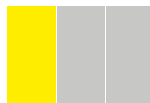

TCS



175 x 350 x 45 mm, 8 pieces

Code	$\Delta \nabla$ g
96 83 03 56	1323

No 20 sizes 6 x 7; 8 x 9; 10 x 11; 12 x 13; 14 x 15; 16 x 17; 18 x 21; 19 x 22 mm

TCS 14/18, 6-24 mm



TCS



350 x 350 x 60 mm, 18 pieces

Code	$\Delta \nabla$ g
96 83 87 50	2348

No 14 sizes 6; 7; 8; 9; 10; 11; 12; 13; 14; 15; 16; 17; 18; 19; 20; 21; 22; 24 mm

TCS 20/10, 6x7-30x32 mm



TCS



350 x 350 x 45 mm, 10 pieces

Code	$\Delta \nabla$ g
96 83 01 66	2450

No 20 sizes 6 x 7; 8 x 9; 10 x 11; 12 x 13; 14 x 15; 16 x 17; 18 x 21; 19 x 22; 24 x 27; 30 x 32 mm

TCS 14/21, 6-36 mm



TCS



530 x 350 x 75 mm, 21 pieces

Code	$\Delta \nabla$ g
96 83 87 71	4988

No 14 sizes 6; 7; 8; 9; 10; 11; 12; 13; 14; 15; 16; 17; 18; 19; 21; 22; 24; 27; 30; 32; 36 mm

TCS 24/7, 8x10-19x22 mm

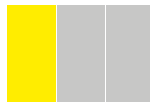

TCS



175 x 350 x 35 mm, 7 pieces

Code	$\Delta \nabla$ g
96 83 87 58	780

No 24 sizes 8 x 10; 10 x 11; 11 x 13; 12 x 14; 14 x 17; 17 x 19; 19 x 22 mm

Factory and workshop equipment, sets of tools

1

TCS 240/6

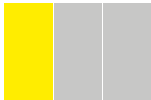

TCS



175 x 350 x 35 mm, 6 pieces

Code	ΔΔ g
96838774	1163
No 240	sizes 10; 11; 13; 14; 17; 19 mm

TCS 29/7, 8x9-20x22 mm

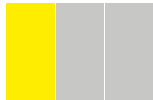

TCS



175 x 350 x 40 mm, 7 pieces

Code	ΔΔ g
96830195	1520
No 29	sizes 8 x 9; 10 x 11; 12 x 13; 14 x 15; 16 x 17; 18 x 19; 20 x 22 mm

TCS 17/12

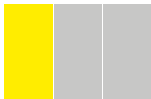

TCS



175 x 350 x 45 mm, 12 pieces

Code	ΔΔ g
96830649	1460
No 17	sizes 8; 9; 10; 11; 12; 13; 14; 15; 16; 17; 18; 19 mm

TCS 4026/3

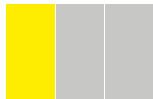

TCS



175 x 350 x 30 mm, 3 pieces

Code	ΔΔ g
96838765	1400
No 4026	sizes 8; 10; 12

TCS 25/7



TCS



175 x 350 x 30 mm, 7 pieces

Code	ΔΔ g
96838751	984
No 25	sizes 7 x 8; 9 x 10; 10 x 11; 12 x 13; 14 x 15; 16 x 18; 17 x 19 mm

TCS 10750/10, 6x7-20x22 mm

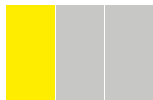

TCS



175 x 350 x 40 mm, 10 pieces

Code	ΔΔ g
96838756	1130
No 10750	sizes 6 x 7; 8 x 9; 10 x 11; 12 x 13; 14 x 15; 16 x 17; 18 x 19; 20 x 22 mm
No 10750 1/2	sizes 6; 7

TCS 29/6, 8x9-18x19 mm



TCS



175 x 350 x 35 mm, 6 pieces

Code	ΔΔ g
96838764	1079
No 29	sizes 8 x 9; 10 x 11; 12 x 13; 14 x 15; 16 x 17; 18 x 19 mm

TCS 1/4" + 10760CV

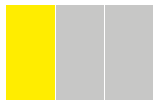

TCS

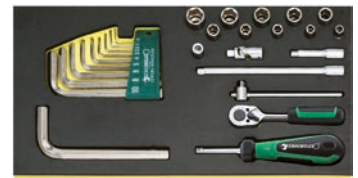

175 x 350 x 43 mm, 27 pieces

Code	ΔΔ g
96838176	987
No 40	1/4" ○ sizes 5.5; 6; 7; 8; 9; 10; 11; 12; 13; 14 mm
No 400	1/4" ■ 150 mm
No 404	1/4" ■ 116 mm
No 405/2	1/4" ■ ○ 54 mm
No 405/6	1/4" ■ ○ 150 mm
No 407	1/4" ■ ○ 38 mm
No 412	1/4" ○ ○
No 415	1/4" ■
No 10760CV	sizes 1.5; 2; 2.5; 3; 4; 5; 6; 8; 10; 12 mm

TCS 40/41/44/8

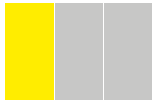

TCS



175 x 350 x 45 mm, 33 pieces

Code		g
96 83 02 17		715
No 40	1/4" \odot sizes 5; 5.5; 6; 7; 8; 9; 10; 11; 12; 13; 14 mm	
No 41K	1/4" \odot \ominus 0.6 x 3.5; 1.0 x 5.5; 1.2 x 8 mm	
No 44K	1/4" \odot \bullet 3; 4; 5; 6; 8 mm	
No 44P	1/4" \odot \oplus sizes 1; 2; 3; 4	
No PZ1221 No PZ1222	1/4" \bullet \oplus size 1 1/4" \bullet \oplus size 2	
No 400	1/4" \blacksquare 150 mm	
No 404	1/4" \blacksquare 116 mm	
No 405/2	1/4" \blacksquare \odot 54 mm	
No 405/6	1/4" \blacksquare \odot 150 mm	
No 407	1/4" \blacksquare \odot 38 mm	
No 409	3/8" \blacksquare 1/4" \odot	
No 412	1/4" \odot \odot	
No 415	1/4" \blacksquare	

TCS 40/35/9



TCS



175 x 350 x 40 mm, 44 pieces

Code		g
96 83 06 01		1045
No 40	1/4" \odot sizes 5; 5.5; 6; 7; 8; 9; 10; 11; 12; 13; 14 mm	
No 40L	1/4" \odot sizes 4; 4.5; 5; 5.5; 6; 7; 8; 9; 10; 11; 12; 13 mm	
No 41K	1/4" \odot \ominus 0.6 x 3.5; 1.0 x 5.5; 1.2 x 8 mm	
No 44K	1/4" \odot \bullet 3; 4; 5; 6; 8 mm	
No 44P	1/4" \odot \oplus sizes 1; 2; 3; 4	
No 400	1/4" \blacksquare 150 mm	
No 404	1/4" \blacksquare 116 mm	
No 405/2 No 405/4	1/4" \blacksquare \odot 54 mm 1/4" \blacksquare \odot 100 mm	
No 405/6	1/4" \blacksquare \odot 150 mm	
No 407	1/4" \blacksquare \odot 38 mm	
No 412	1/4" \odot \odot	
No 415	1/4" \blacksquare	
No 409	3/8" \blacksquare 1/4" \odot	

TCS 4008/8/52

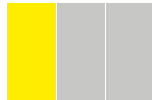

TCS

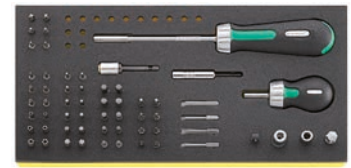

175 x 350 x 50 mm, 60 pieces

Code		g
96 83 87 73		665
No 412	1/4" \odot \odot	
No 412/1	1/4" \odot 10 mm \bullet	
No 442	1/4" \odot 3/8" \odot	
No 1200/1	1/4" \odot \bullet	
No 3825/1	1/4" \odot \bullet	
No 3115/1	1/4" \blacksquare \bullet	
No 4008-1	1/4" \odot	
No 4008-2	1/4" \odot	
No 1300 No 1301 No 1302 No 1303 No 1304	size 3 mm (2x) size 4 mm (2x) size 5 mm (2x) size 6 mm (2x) size 8 mm (2x)	
No 1220 No 1221 No 1222 No 1223	size 0 (2x) size 1 (2x) size 2 (2x) size 3 (2x)	
No PZ1221 No PZ1222 No PZ1223	size 1 (2x) size 2 (2x) size 3 (2x)	
No 1414 No 1415 No 1416 No 1417 No 1419 No 1420	size T10 (2x) size T15 (2x) size T20 (2x) size T25 (2x) size T30 (2x) size T40 (2x)	
No 1440 No 1441 No 1442 No 1443 No 1445 No 1446	size T10 (2x) size T15 (2x) size T20 (2x) size T25 (2x) size T30 (2x) size T40 (2x)	
No 1161 No 1163 No 1165 No 1166/1	size 0.5 x 4.0 mm size 0.6 x 4.5 mm size 0.8 x 5.5 mm size 1.2 x 6.5 mm	

Tool Control System

The safety inlay system

- Designed to fit our Tool Trolleys and Tool Boxes
- With yellow signal cut-outs to show whether all tools are in their places

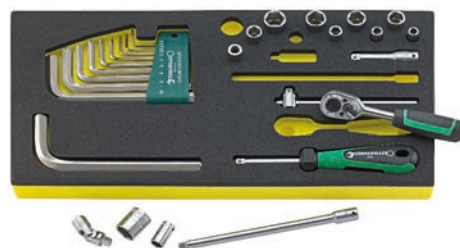

TCS

Factory and workshop equipment, sets of tools

1

TCS 456/16/6

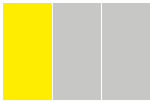

175 x 350 x 45 mm, 22 pieces

Code		Δ g
96 83 87 52		1500
No 456	$\frac{3}{8}$ " \bigcirc sizes 7; 8; 9; 10; 11; 12; 13; 14; 15; 16; 17; 18; 19; 20; 21; 22 mm	
No 425	$\frac{3}{8}$ " \blacksquare 165 mm	
No 427/3	$\frac{3}{8}$ " \blacksquare \bigcirc 76 mm	
No 427/6	$\frac{3}{8}$ " \blacksquare \bigcirc 160 mm	
No 427/10	$\frac{3}{8}$ " \blacksquare \bigcirc 240 mm	
No 428	$\frac{3}{8}$ " \blacksquare \bigcirc 46 mm	
No 435	$\frac{3}{8}$ " \blacksquare	

TCS 456/16/7

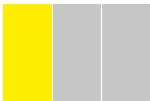

175 x 350 x 40 mm, 23 pieces

Code		Δ g
96 83 02 18		1400
No 456	$\frac{3}{8}$ " \bigcirc sizes 7; 8; 9; 10; 11; 12; 13; 14; 15; 16; 17; 18; 19; 20; 21; 22 mm	
No 427/3	$\frac{3}{8}$ " \blacksquare \bigcirc 76 mm	
No 427/5	$\frac{3}{8}$ " \blacksquare \bigcirc 125 mm	
No 427/10	$\frac{3}{8}$ " \blacksquare \bigcirc 240 mm	
No 428	$\frac{3}{8}$ " \blacksquare \bigcirc 46 mm	
No 431	$\frac{1}{4}$ " \blacksquare $\frac{3}{8}$ " \bigcirc	
No 432	$\frac{1}{2}$ " \blacksquare $\frac{3}{8}$ " \bigcirc	
No 435	$\frac{3}{8}$ " \blacksquare	

TCS 456/16/4 MF



175 x 350 x 45 mm, 20 pieces

Code		Δ g
96 83 03 57		1123
No 456	$\frac{3}{8}$ " \bigcirc sizes 7; 8; 9; 10; 11; 12; 13; 14; 15; 16; 17; 18; 19; 20; 21; 22 mm	
No 427/5	$\frac{3}{8}$ " \blacksquare \bigcirc 125 mm	
No 427/10	$\frac{3}{8}$ " \blacksquare \bigcirc 240 mm	
No 428	$\frac{3}{8}$ " \blacksquare \bigcirc 46 mm	
No 435	$\frac{3}{8}$ " \blacksquare	

TCS 456/31/8



350 x 350 x 32 mm, 39 pieces

Code		Δ g
96 83 06 02		2701
No 456	$\frac{3}{8}$ " \bigcirc sizes 7; 8; 9; 10; 11; 12; 13; 14; 15; 16; 17; 18; 19; 20; 21; 22 mm	
No 46	$\frac{3}{8}$ " \bigcirc sizes 10; 11; 12; 13 mm	
No 47	$\frac{3}{8}$ " \bigcirc sizes 10; 11; 12; 13; 14; 15; 16 mm	
No 1049	$\frac{3}{8}$ " \bigcirc size 9 mm	
No 49X	$\frac{3}{8}$ " \bigcirc sizes M6; M8; M10	
No 427/3	$\frac{3}{8}$ " \blacksquare \bigcirc 76 mm	
No 427/5	$\frac{3}{8}$ " \blacksquare \bigcirc 125 mm	
No 427/10	$\frac{3}{8}$ " \blacksquare \bigcirc 240 mm	
No 428	$\frac{3}{8}$ " \blacksquare \bigcirc 46 mm	
No 431	$\frac{1}{4}$ " \blacksquare $\frac{3}{8}$ " \bigcirc	
No 432	$\frac{1}{2}$ " \blacksquare $\frac{3}{8}$ " \bigcirc	
No 435	$\frac{3}{8}$ " \blacksquare	
No 452	$\frac{3}{8}$ " \blacksquare	

TCS 49/1049/2049/45TX/49TX

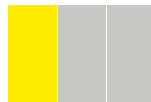

175 x 350 x 40 mm, 24 pieces

Code		Δ g
96 83 87 72		1200
No 49	$\frac{3}{8}$ " \bigcirc sizes 4; 5; 6; 7; 8; 10 mm	
No 1049	$\frac{3}{8}$ " \bigcirc size 7 mm	
No 2049	$\frac{3}{8}$ " \bigcirc sizes 4; 5; 6; 8; 10 mm	
No 45TX	$\frac{3}{8}$ " \bigcirc sizes E5; E6; E7; E8; E10; E12	
No 49TX	$\frac{3}{8}$ " \bigcirc sizes T10; T15; T20; T25; T30; T40	

TCS 1/2"-512/6

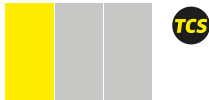

175 x 350 x 35 mm, 6 pieces

Code		Δ	g
96 83 81 75			1845
	No 506	1/2" ■	300 mm
	No 509/2	1/2" ■ ○	52 mm
	No 509/5	1/2" ■ ○	130 mm
	No 509/10	1/2" ■ ○	255 mm
	No 510	1/2" ■ ○	71 mm
	No 512	1/2" ■	

TCS 1/2"-512/9

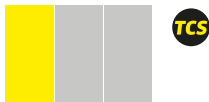

175 x 350 x 40 mm, 9 pieces

Code		Δ	g
96 83 06 03			2364
	No 506	1/2" ■	300 mm
	No 509QR/2	1/2" ■ ○	52 mm
	No 509/5	1/2" ■ ○	130 mm
	No 509QR/10	1/2" ■ ○	255 mm (2x)
	No 510	1/2" ■ ○	71 mm
	No 512	1/2" ■	
	No 513	3/8" ■ 1/2" ○	
	No 514	3/4" ■ 1/2" ○	

TCS 52/14/4

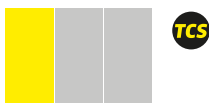

175 x 350 x 50 mm, 18 pieces

Code		Δ	g
96 83 87 81			2510
	No 52	1/2" ○ sizes 10; 11; 12; 13; 14; 15; 16; 17; 18; 19; 22; 24; 27; 30 mm	
	No 509/5	1/2" ■ ○	130 mm
	No 509/10	1/2" ■ ○	255 mm
	No 510	1/2" ■ ○	71 mm
	No 512	1/2" ■	

TCS 50/52/30/6 MF

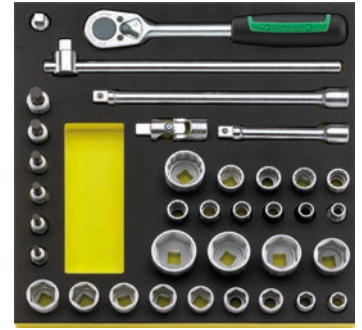
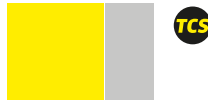

350 x 350 x 70 mm, 36 pieces

Code		Δ	g
96 83 03 54			4604
	No 50	1/2" ○ sizes 10; 11; 12; 13; 14; 15; 16; 17; 18; 19; 30 mm	
	No 52	1/2" ○ sizes 12; 13; 17; 18; 19; 20; 21; 22; 24; 27; 30; 32; 34 mm	
	No 54	1/2" ○ sizes 5; 6; 7; 8; 10; 12 mm	
	No 506	1/2" ■	300 mm
	No 509/5	1/2" ■ ○	130 mm
	No 509/10	1/2" ■ ○	255 mm
	No 510	1/2" ■ ○	71 mm
	No 512	1/2" ■	
	No 513	3/8" ■ 1/2" ○	

TCS 50/51/52/32

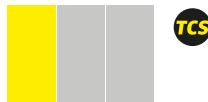

175 x 350 x 50 mm, 32 pieces

Code		Δ	g
96 83 81 91			2950
	No 50	1/2" ○ sizes 8; 9; 10; 11; 12; 13; 14; 15; 16; 17; 18; 19; 30 mm	
	No 52	1/2" ○ sizes 10; 11; 12; 13; 14; 15; 16; 17; 18; 19; 20; 21; 22; 24; 27; 30; 32 mm	
	No 51	1/2" ○ sizes 22; 27 mm	

TCS 51/11

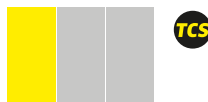

175 x 350 x 50 mm, 11 pieces

Code		Δ	g
96 83 87 76			2360
	No 51	sizes 10; 13; 15; 17; 18; 19; 22; 24; 27; 30; 32 mm	

Factory and workshop equipment, sets of tools

1

TCS 52/17

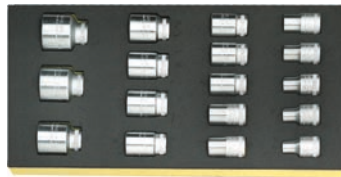
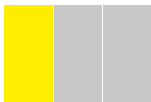

175 x 350 x 40 mm, 17 pieces

Code	g
96838177	1605

	No 52	1/2" \circ sizes 10; 11; 12; 13; 14; 15; 16; 17; 18; 19; 20; 21; 22; 24; 27; 30; 32 mm
--	--------------	--

TCS 52/18 MF

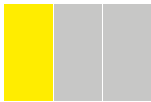

175 x 350 x 55 mm, 18 pieces

Code	g
96830359	1850

	No 52	1/2" \circ sizes 10; 11; 12; 13; 14; 15; 16; 17; 18; 19; 20; 21; 22; 24; 27; 30; 32; 34 mm
--	--------------	--

TCS 50a/17

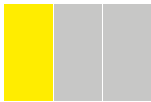

175 x 350 x 40 mm, 17 pieces

Code	g
96838780	1600

	No 50a	1/2" \circ sizes 3/8; 7/16; 1/2; 9/16; 19/32; 5/8; 11/16; 3/4; 25/32; 13/16; 7/8; 15/16; 1; 1 1/16; 1 1/8; 1 3/16; 1 1/4"
--	---------------	---

TCS 54/54TX/18

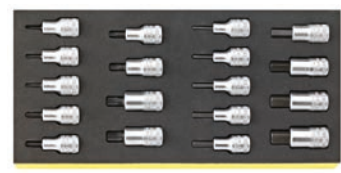
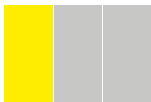

175 x 350 x 40 mm, 18 pieces

Code	g
96838782	1665

	No 54	1/2" \circ sizes 4; 5; 6; 7; 8; 10; 12; 14; 17 mm
--	--------------	---

	Nr. 54TX	1/2" \circ sizes T20; T25; T27; T30; T40; T45; T50; T55; T60
--	-----------------	--

TCS 40/456/52/78/19



530 x 350 x 60 mm, 97 pieces

Code	g
96832095	7000

	No 40	1/4" \circ sizes 4; 5; 5.5; 6; 7; 8; 9; 10; 11; 12; 13 mm
--	--------------	---

	No 44K	1/4" \circ sizes 3; 4; 5; 6; 8 mm
--	---------------	-------------------------------------

	No 456	3/8" \circ sizes 8; 9; 10; 11; 12; 13; 14; 15; 16; 17; 18; 19; 20; 21; 22 mm
--	---------------	--

	No 49	3/8" \circ sizes 5; 6; 8 mm
--	--------------	-------------------------------

	No 52	1/2" \circ sizes 10; 11; 12; 13; 14; 15; 16; 17; 18; 19; 21; 22; 24; 27; 30; 32; 34 mm
--	--------------	--

	No 54	1/2" \circ sizes 10; 12 mm
--	--------------	------------------------------

	No 40TX	1/4" \circ sizes E8; E10
--	----------------	----------------------------

	No 44KTXB	1/4" \circ sizes T8; T10; T15; T20; T25; T27; T30; T40
--	------------------	--

	No 45TX	3/8" \circ sizes E8; E10; E12; E14
--	----------------	--------------------------------------

	No 49TX No 54TX	3/8" \circ sizes T25; T45 1/2" \circ sizes T40; T50; T55; T60
--	----------------------------------	--

	No 1054TX No 2054TX	1/2" \circ sizes T50; T55 1/2" \circ sizes T40; T45
--	--------------------------------------	--

	No 400	1/4" \blacksquare 150 mm
--	---------------	----------------------------

	No 404	1/4" \blacksquare 116 mm
--	---------------	----------------------------

	No 405/2 No 405/4	1/4" \blacksquare \circ 54 mm 1/4" \blacksquare \circ 100 mm
--	------------------------------------	---

	No 407	1/4" \blacksquare \circ 38 mm
--	---------------	-----------------------------------

	No 412	1/4" \circ \circ
--	---------------	----------------------

	No 415	1/4" \blacksquare
--	---------------	---------------------

	No 425	3/8" \blacksquare 165 mm
--	---------------	----------------------------

	No 427/3	3/8" \blacksquare \circ 76 mm
--	-----------------	-----------------------------------

	No 427/10	3/8" \blacksquare \circ 240 mm
--	------------------	------------------------------------

	No 428	3/8" \blacksquare \circ 46 mm
--	---------------	-----------------------------------

	No 431	1/4" \blacksquare 3/8" \circ
--	---------------	----------------------------------

	No 432	1/2" \blacksquare 3/8" \circ
--	---------------	----------------------------------

	No 435	3/8" \blacksquare
--	---------------	---------------------

	No 506	1/2" \blacksquare 300 mm
--	---------------	----------------------------

	No 509/5	1/2" \blacksquare \circ 130 mm
--	-----------------	------------------------------------

	No 509/10	1/2" \blacksquare \circ 255 mm
--	------------------	------------------------------------

	No 510	1/2" \blacksquare \circ 71 mm
--	---------------	-----------------------------------

	No 512	1/2" \blacksquare
--	---------------	---------------------

	No 513	3/8" \blacksquare 1/2" \circ
--	---------------	----------------------------------

TCS 40/45/50/89/19



TCS

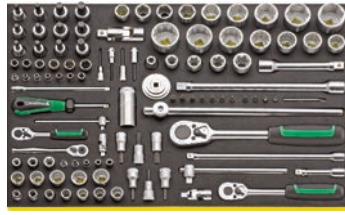

530 x 350 x 70 mm, 108 pieces

Code		△ g
96 83 01 92		7770
No 40	1/4" ○ sizes 3.5; 4; 4.5; 5; 5.5; 6; 7; 8; 9; 10; 11; 12; 13 mm	
No 44	1/4" ○ sizes 3; 4; 5; 6 mm	
No 400	1/4" ■ 150 mm	
No 404	1/4" ■ 116 mm	
No 405/6	1/4" ■ ○ 150 mm	
No 407	1/4" ■ ○ 38 mm	
No 409M	3/8" ■ 1/4" ○	
No 415	1/4" ■	
No 45	3/8" ○ sizes 8; 9; 10; 11; 12; 13; 14; 15; 16; 17; 18; 19 mm	
No 46	3/8" ○ size 20.8 mm-13/16"	
No 49	3/8" ○ sizes 4; 5; 6; 7; 8; 10 mm	
No 425	3/8" ■ 165 mm	
No 427/3	3/8" ■ ○ 76 mm	
No 427/10	3/8" ■ ○ 240 mm	
No 428	3/8" ■ ○ 46 mm	
No 432M	1/2" ■ 3/8" ○	
No 435	3/8" ■	
No 50	1/2" ○ sizes 19; 21; 22; 24; 27; 30; 32 mm	
No 52	1/2" ○ sizes 16; 17; 18; 19; 22; 24; 27; 30; 32 mm	
No 54	1/2" ○ sizes 6; 7; 8; 10 mm	
No 54X	1/2" ○ sizes M6; 8; 12; 14	
No 506	1/2" ■ 300 mm	
No 509/5	1/2" ■ ○ 130 mm	
No 509/10	1/2" ■ ○ 255 mm	
No 510	1/2" ■ ○ 71 mm	
No 512	1/2" ■	
No 514M	3/4" ■ 1/2" ○	
No 40TX No 45TX	1/4" ○ sizes E4; E5; E6; E7; E8 3/8" ○ sizes E10; E12; E14	
No 50TX	1/2" ○ sizes E11; E16; E18; E20; E24	
No 54TX	1/2" ○ sizes T45; T50; T55; T60	
No 1410 No 1411 No 1412 No 1413 No 1440 No 1441 No 1442 No 1443 No 1444 No 1445 No 1446 No 1427	size T6 size T7 size T8 size T9 size T10 size T15 size T20 size T25 size T27 size T30 size T40 size T25 (65 mm)	
No 415SGB N	1/4" ○	

TCS 50TX/54TX/17



TCS



175 x 350 x 40 mm, 17 pieces

Code		△ g
96 83 87 63		1382
No 50TX	1/2" ○ sizes E10; E11; E12; E14; E16; E18; E20; E24	
No 54TX	1/2" ○ sizes T20; T25; T27; T30; T40; T45; T50; T55; T60	

TCS 54/2309K/12506



TCS



175 x 350 x 40 mm, 13 pieces

Code		△ g
96 83 01 63		1830
No 54	1/2" ○ sizes 5; 6; 7; 8; 10; 12; 14; 17; 19 mm	
No 2309K	1/2" ○ sizes 17; 19 mm	
No 12506	sizes 6; 7 mm	

TCS 54/54X/16



TCS



175 x 350 x 35 mm, 16 pieces

Code		△ g
96 83 87 62		1665
No 54	1/2" ○ sizes 4; 5; 6; 7; 8; 10; 12; 14; 17 mm	
No 54X	1/2" ○ sizes M5; M6; M8; M10; M12; M14; M16	

TCS 1054/2054/10

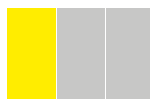

TCS



175 x 350 x 40 mm, 10 pieces

Code		△ g
96 83 87 60		1272
No 1054 No 2054	1/2" ○ sizes 8; 10; 12 mm 1/2" ○ sizes 5; 6 mm	
No 1054TX No 2054TX	1/2" ○ sizes T30; T50; T55 1/2" ○ sizes T40; T45	

Factory and workshop equipment, sets of tools

1

TCS 55/11/6



530 x 350 x 90 mm, 17 pieces

Code	g	
96 83 02 21	10100	
No 55	3/4" \bigcirc sizes 22; 24; 27; 30; 32; 34; 36; 38; 41; 46; 50 mm	
No 552	3/4" \blacksquare	
No 556	3/4" \blacksquare	
No 558	510 mm	
No 559/8	3/4" \blacksquare \bigcirc 200 mm	
No 559/16	3/4" \blacksquare \bigcirc 400 mm	
No 568	1/2" \blacksquare 3/4" \bigcirc	

TCS TX/57 MF N

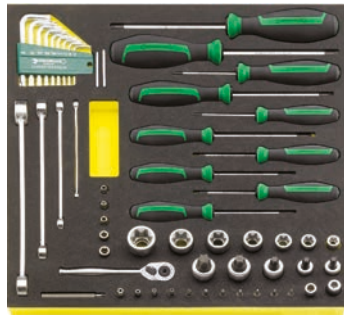

350 x 350 x 75 mm, 57 pieces

Code	g	
96 83 04 50	2060	
No 21TX	sizes E6 x E8; E10 x E12; E14 x E18; E20 x E24	
No 40TX	1/4" \bigcirc sizes E4; E5; E6; E7; E8	
No 45TX	3/8" \bigcirc sizes E10; E12; E14	
No 49TX	3/8" \bigcirc sizes T40; T45	
No 50TX	1/2" \bigcirc sizes E16; E18; E20; E24	
No 54TX	1/2" \bigcirc sizes T50; T55; T60	
No 4155GB N	1/4" \bigcirc	
No 412	1/4" \bigcirc \bigcirc	
No 442	1/4" \bigcirc 3/8" \bigcirc	
No 1410	size T6	
No 1411	size T7	
No 1412	size T8	
No 1413	size T9	
No 1440	size T10	
No 1441	size T15	
No 1442	size T20	
No 1443	size T25	
No 1444	size T27	
No 1445	size T30	
No 1446	size T40	
No 1427	size T25 (65 mm)	
No 4650	sizes T6; T7; T8; T9; T10; T15; T20; T25; T27; T30	
No 10766	sizes T6; T7	
No 10766/9	sizes T8; T9; T10; T15; T20; T25; T27; T30; T40	

TCS 50IMP/51IMP/19

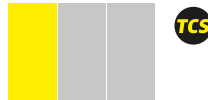

170 x 350 x 50 mm, 19 pieces

Code	g	
96 83 87 77	3960	
No 50IMP	1/2" \bigcirc sizes 10; 13; 15; 16; 17; 18; 19; 21; 22; 24; 27 mm	
No 51IMP	1/2" \bigcirc sizes 13; 15; 17; 18; 19; 21; 22; 24 mm	

TCS 50IMP/19/2

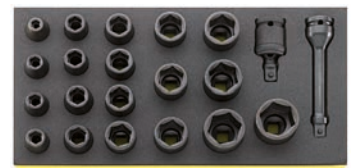
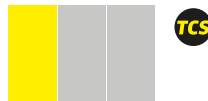

175 x 350 x 50 mm, 21 pieces

Code	g	
96 83 87 91	3065	
No 50IMP	sizes 8; 10; 11; 12; 13; 14; 15; 16; 17; 18; 19; 21; 22; 23; 24; 25; 27; 30; 32 mm	
No 509/5IMP	1/2" \blacksquare \bigcirc 125 mm	
No 510IMP	1/2" \blacksquare \bigcirc 68 mm	

TCS 54IMP/2307TX/15

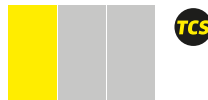

175 x 350 x 40 mm, 15 pieces

Code	g	
96 83 87 92	1285	
No 54IMP	1/2" \bigcirc sizes 5; 6; 7; 8; 10; 12; 14; 17; 19 mm	
No 2307TX	1/2" \bigcirc sizes T30; T40; T45; T50; T55; T60	

TCS 4620/4630

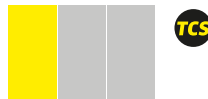

175 x 350 x 35 mm, 7 pieces

Code	g	
96 83 82 78	590	
No 4620	size 1 (0.6 x 3.5 x 75 mm) size 2 (0.8 x 4.0 x 100 mm) size 3 (1.0 x 5.5 x 125 mm) size 4 (1.2 x 6.5 x 150 mm)	
No 4630	sizes 1; 2; 3	

TCS 4620/4640

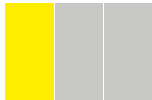

TCS



175 x 350 x 40 mm, 7 pieces

Code	g
96 83 87 84	410
No 4620	size 1 (0.6 x 3.5 x 75 mm) size 2 (0.8 x 4.0 x 100 mm) size 3 (1.0 x 5.5 x 125 mm) size 4 (1.2 x 6.5 x 150 mm)
No 4640	sizes PZ1; PZ2; PZ3

TCS 4620/4660VDE+10767



TCS



530 x 350 x 35 mm, 27 pieces

Code	g
96 83 11 68	2080
No 4620	size 1 (0.6 x 3.5 x 75 mm) size 2 (0.8 x 4.0 x 100 mm) size 4 (1.2 x 6.5 x 150 mm) size 5 (1.6 x 8.0 x 175 mm) size 6 (1.6 x 10.0 x 200 mm) size 7 (2.0 x 12.0 x 200 mm)
No 4628	size 1 (0.4 x 2.5 x 60 mm)
No 4630	sizes 1; 2; 3
No 4632	size 4
No 4640	sizes 0; 1; 2
No 4660 VDE	size 1 (0.4 x 2.5 x 75 mm)
No 4724	size 2 (1.0 x 5.5 x 25 mm)
No 4734 No 4744	size 2 size 1
No 10767/9	sizes 1.5; 2; 2.5; 3; 4; 5; 6; 8; 10 mm

TCS 4620-4734/8



TCS



175 x 350 x 40 mm, 8 pieces

Code	g
96 83 87 69	503
No 4620	size 1 (0.6 x 3.5 x 75 mm) size 3 (1.0 x 5.5 x 125 mm) size 4 (1.2 x 6.5 x 150 mm)
No 4628	size 1 (0.4 x 2.5 x 60 mm)
No 4630	sizes 1; 2
No 4724	size 2 (1.0 x 5.5 x 25 mm)
No 4734	size 2

TCS 4620/4660VDE



TCS

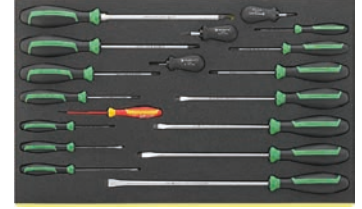

530 x 350 x 40 mm, 18 pieces

Code	g
96 83 11 79	1689
No 4620	size 1 (0.6 x 3.5 x 75 mm) size 2 (0.8 x 4.0 x 100 mm) size 4 (1.2 x 6.5 x 150 mm) size 5 (1.6 x 8.0 x 175 mm) size 6 (1.6 x 10.0 x 200 mm) size 7 (2.0 x 12.0 x 200 mm)
No 4628	size 1 (0.4 x 2.5 x 60 mm)
No 4630	sizes 1; 2; 3
No 4632	size 4
No 4640	sizes 0; 1; 2
No 4660 VDE	size 1 (0.4 x 2.5 x 75 mm)
No 4724	size 2 (1.0 x 5.5 x 25 mm)
No 4734 No 4744	size 2 size 1

TCS 4621/4734/16



TCS



530 x 350 x 40 mm, 16 pieces

Code	g
96 83 20 98	1490
No 4621	size 0 (0.4 x 2.5 x 80 mm) size 1 (0.5 x 3.5 x 90 mm) size 2 (0.6 x 4.0 x 100 mm) size 4 (1.0 x 6.5 x 140 mm) size 5 (1.2 x 8.0 x 160 mm)
No 4631	sizes 1; 2
No 4632	sizes 1; 2; 3
No 4724	size 2 (1.0 x 5.5 x 25 mm)
No 4734	size 2
No 10506	0.8 x 4.0 x 300 mm
No 10518	1.0 x 5.5 x 410 mm
No 12600	500 g
No 12922E	∅ 6 mm

Factory and workshop equipment, sets of tools

1

TCS 4622/4632



TCS



175 x 350 x 35 mm, 6 pieces

Code	♻️ g
96 83 87 83	845

No 4622	size 1 (1.0 x 5.5 x 100 mm) size 2 (1.2 x 6.5 x 125 mm) size 3 (1.2 x 8.0 x 150 mm) size 4 (1.6 x 10.0 x 175 mm)
No 4632	sizes 2; 3

TCS 4622/4650+10760+10766



TCS

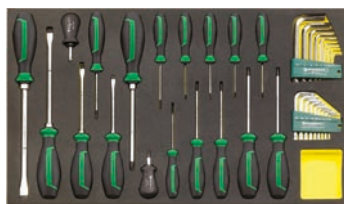

530 x 350 x 40 mm, 36 pieces

Code	♻️ g
96 83 11 96	1895

No 4622	size 1 (1.0 x 5.5 x 100 mm) size 2 (1.2 x 6.5 x 125 mm) size 4 (1.6 x 10.0 x 175 mm) size 5 (2.0 x 12.0 x 200 mm)
No 4630	size 1
No 4632	size 3
No 4650	sizes T6; T7; T8; T9; T10; T15; T20; T25; T27; T30
No 4724	size 2 (1.0 x 5.5 x 25 mm)
No 4734	size 2
No 10760CV/9	sizes 1.5; 2; 2.5; 3; 4; 5; 6; 8; 10 mm
No 10766/9	sizes T8; T9; T10; T15; T20; T25; T27; T30; T40

TCS 4650



TCS



175 x 350 x 35 mm, 8 pieces

Code	♻️ g
96 83 87 67	350

No 4650	sizes T8; T9; T10; T15; T20; T25; T27; T30
----------------	--

TCS 4660/4665 VDE

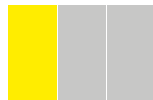

TCS



175 x 350 x 40 mm, 6 pieces

Code	♻️ g
96 83 87 66	400

No 4660 VDE	size 1 (0.4 x 2.5 x 75 mm) size 3 (0.6 x 3.5 x 100 mm) size 5 (1.0 x 5.5 x 125 mm) size 6 (1.2 x 6.5 x 150 mm)
No 4665 VDE	sizes 1; 2

TCS 4665/4670 VDE

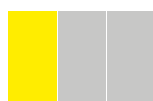

TCS



175 x 350 x 40 mm, 7 pieces

Code	♻️ g
96 83 87 85	560

No 4665 VDE No 4670 VDE	sizes PH0; PH1; PH2; PH3 sizes PZ0; PZ1; PZ2
--	---

TCS 4724/4840+10767



TCS



530 x 350 x 45 mm, 24 pieces

Code	♻️ g
96 83 07 06	1755

No 4628	size 1 (0.4 x 2.5 x 60 mm)
No 4724	size 2 (1.0 x 5.5 x 25 mm)
No 4734 No 4744	size 2 size 1
No 4820	0.6 x 3.5 x 75 mm 0.8 x 4.0 x 100 mm 1.2 x 6.5 x 150 mm 1.6 x 10.0 x 200 mm 2.0 x 12.0 x 250 mm
No 4830 No 4840	sizes 1; 2; 3 size 1
No 10767/9	sizes 1.5; 2; 2.5; 3; 4; 5; 6; 8; 10 mm
No 7756	
No 12922E	∅ 6 mm

TCS 4820/4830

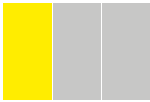

TCS



175 x 350 x 35 mm, 7 pieces

Code	Δ7 g
96 83 81 84	555

No 4820	0.6 x 3.5 x 75 mm
	0.8 x 4.0 x 100 mm
	1.0 x 5.5 x 125 mm
	1.2 x 6.5 x 150 mm

No 4830	sizes 1; 2; 3
----------------	---------------

TCS 4856

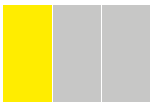

TCS

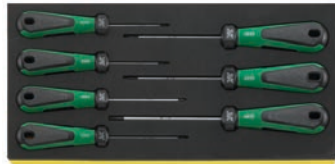

175 x 350 x 40 mm, 7 pieces

Code	Δ7 g
96 83 87 55	447

No 4856	sizes T8; T9; T10; T15; T20; T25; T30
----------------	---------------------------------------

TCS 12500N/5

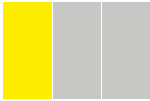

TCS



175 x 350 x 45 mm, 5 pieces

Code	Δ7 g
96 83 87 57	730

No 12500N	sizes 7; 8; 10; 12; 13 mm
------------------	---------------------------

TCS 12507-2K/5



TCS



175 x 350 x 40 mm, 5 pieces

Code	Δ7 g
96 83 87 61	792

No 12507-2K	sizes 7; 8; 10; 12; 13 mm
--------------------	---------------------------

TCS 10768/8



TCS



350 x 350 x 40 mm, 8 pieces

Code	Δ7 g
96 83 87 86	740

No 10768	sizes 2; 2.5; 3; 4; 5; 6; 8; 10 mm
-----------------	------------------------------------

TCS 10765/10768/12507/19



TCS



530 x 350 x 30 mm, 19 pieces

Code	Δ7 g
96 83 06 21	1640

No 10765/9	sizes 1.5; 2; 2.5; 3; 4; 5; 6; 8; 10 mm
-------------------	---

No 10768	sizes 2.5; 3; 4; 5; 6; 8; 10 mm
-----------------	---------------------------------

No 12507-2K	sizes 8; 10; 13 mm
--------------------	--------------------

TCS 10768-2K/6



TCS



350 x 350 x 40 mm, 6 pieces

Code	Δ7 g
96 83 87 53	792

No 10768-2K	sizes 3; 4; 5; 6; 8; 10 mm
--------------------	----------------------------

Factory and workshop equipment, sets of tools

1

TCS 10769+10771/17



TCS



350 x 350 x 30 mm, 17 pieces

Code

△△
g

96 83 20 99

940



No 10769

sizes T9; T10; T15; T20; T25; T30; T40; T45; T50



No 10771/8

sizes T9; T10; T15; T20; T25; T27; T30; T40

TCS 10760-10771/26

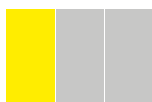

TCS

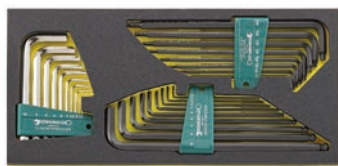

175 x 350 x 35 mm, 26 pieces

Code

△△
g

96 83 87 88

990



No 10760CV/9

sizes 1.5; 2; 2.5; 3; 4; 5; 6; 8; 10 mm



No 10767/9

sizes 1.5; 2; 2.5; 3; 4; 5; 6; 8; 10 mm



No 10771/8

sizes T9; T10; T15; T20; T25; T27; T30; T40

TCS 1201/4000/10766/38

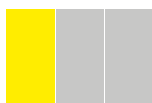

TCS



175 x 350 x 45 mm, 38 pieces

Code

△△
g

96 83 87 68

880



No 10767/9

sizes 1.5; 2; 2.5; 3; 4; 5; 6; 8; 10 mm



No 10766/9

sizes T8; T9; T10; T15; T20; T25; T27; T30; T40

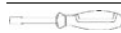

No 4000

1/4" ○



No 1201

1/4" ●, ⊖ sizes 0.6 x 4.5; 0.8 x 5.5; 1.2 x 6.5;
1/4" ●, ⊕ sizes 1; 2; 3;
1/4" ●, ⊕ sizes 1; 2; 3;
1/4" ●, ⊕ sizes T10; T15; T20; T25; T30; T40;
1/4" ●, ● sizes 4; 5; 6 mm;
1/4" ○, 1/4" ● bitholder

TCS 4751/4752

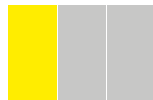

TCS



175 x 350 x 35 mm, 9 pieces

Code

△△
g

96 83 87 87

280



No 4751

size 4 (0.3 x 1.5 x 40 mm)
size 6 (0.4 x 2.0 x 60 mm)
size 7 (0.4 x 2.5 x 75 mm)
size 8 (0.5 x 3.0 x 75 mm)

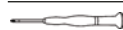

No 4752

sizes PH00; PH0; PH1



No 65 40 6 120



No 66 04 6 110

TCS 6501-6602/3



TCS



175 x 350 x 40 mm, 3 pieces

Code

△△
g

96 83 87 75

1115



No 65 01 5 200



No 65 51 6 300



No 66 02 5 180

TCS 6501-6602/4



TCS



175 x 350 x 35 mm, 4 pieces

Code

△△
g

96 83 81 79

1010



No 65 01 5 180



No 65 29 5 200



No 65 51 6 240



No 66 02 5 160

TCS 6501-6602/4N

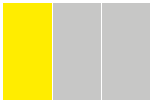

TCS

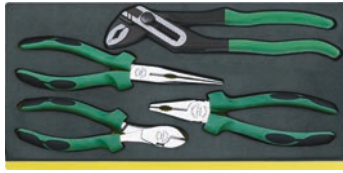

175 x 350 x 35 mm, 4 pieces

Code	g
96 83 06 22	1080

-  **No 65 01 5 180**
-  **No 65 29 5 200**
-  **No 65 72 6 240**
-  **No 66 02 5 160**

TCS 6543-6564/3



TCS



175 x 350 x 30 mm, 3 pieces

Code	g
96 83 81 80	815

-  **No 65 43 4 002**
-  **No 65 45 4 002**
-  **No 65 64 2 250**

TCS 6543-6546/4





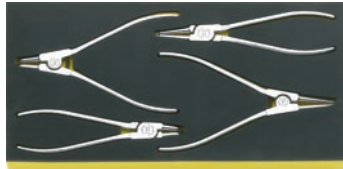

TCS



175 x 350 x 30 mm, 4 pieces

Code	g
96 83 06 08	626

-  **No 65 43 4 002**
-  **No 65 44 4 021**
-  **No 65 45 4 002**
-  **No 65 46 4 021**

TCS 6534-6545/6



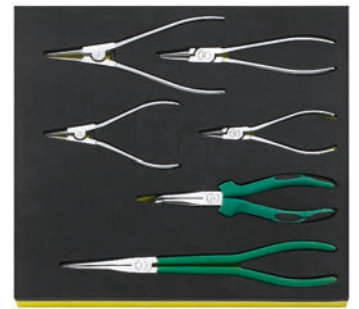

TCS



350 x 350 x 30 mm, 6 pieces

Code	g
96 83 21 00	1070

-  **No 65 34 5 280**
-  **No 65 35 5 200**
-  **No 65 43 4 001**
No 65 43 4 002
-  **No 65 45 4 001**
No 65 45 4 002

TCS 6501-6600/3

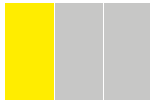



TCS



175 x 350 x 40 mm, 3 pieces

Code	g
96 83 87 70	740

-  **No 65 01 7 180**
-  **No 65 29 7 200**
-  **No 66 00 7 160**

TCS 102-109/10956/10960/6







TCS

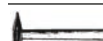

175 x 350 x 40 mm, 6 pieces

Code	g
96 83 81 81	1500

-  **No 10956** \varnothing 35 mm
-  **No 10960** 500 g
-  **No 102** 175 mm
-  **No 108** 150 x 6; 175 x 6 mm
-  **No 109** size 6; 100 x 3.4 mm

Factory and workshop equipment, sets of tools

1

TCS 102-108/10960/10

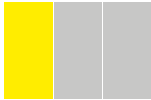

TCS



175 x 350 x 40 mm, 10 pieces

Code	g
96830361	1569
No 102	200 mm
No 105	120 x 12 mm
No 108	115 x 2; 150 x 3; 150 x 4; 150 x 5; 150 x 6; 175 x 4; 200 x 8 mm
No 10960	500 g

TCS 102-108/11

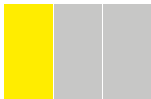

TCS



175 x 350 x 33 mm, 11 pieces

Code	g
96838754	1665
No 102	150; 200; 250 mm
No 105	120 x 10; 120 x 12 mm
No 108	150 x 2.5; 150 x 3; 150 x 4; 150 x 5; 150 x 6; 150 x 8 mm

TCS 102-108/10957/10960/16



TCS



530 x 350 x 45 mm, 16 pieces

Code	g
96830609	3715
No 102	200 mm
No 103	150 mm
No 105	120 x 10 mm
No 108	150 x 3; 150 x 4; 150 x 5; 150 x 6; 150 x 8 mm
No 10957	∅ 40 mm
No 10960	500 g
No 12373	
No 12600	500 g
No 12718	
No 12935/3	3 m
No 65 64 2 250	
No 39 Pkw	400 mm

TCS 102-108/10957/10960/13



TCS



530 x 350 x 60 mm, 13 pieces

Code	g
96830177	5540
No 102	200; 300 mm
No 103	175 mm
No 105	120 x 12 mm
No 108	150 x 3; 150 x 4; 150 x 5; 150 x 6; 150 x 8 mm
No 10957	∅ 50 mm
No 10960	500; 800; 1000 g

TCS 102-108/10957/10960 MF



TCS



530 x 350 x 40 mm, 12 pieces

Code	g
96830355	3343
No 102	200 mm
No 103	150 mm
No 105	120 x 10 mm
No 108	150 x 3; 150 x 4; 150 x 5; 150 x 6; 150 x 8 mm
No 10957	∅ 40 mm
No 10960	500; 800 g
No 12718	

TCS 102-108/10957/12718/13



TCS



530 x 350 x 40 mm, 13 pieces

Code	g
96830226	3730
No 102	200 mm
No 103	150 mm
No 105	120 x 10 mm
No 108	150 x 3; 150 x 4; 150 x 5; 150 x 6; 150 x 8; 200 x 8 mm
No 10957	∅ 40 mm
No 10960	500; 800 g
No 12718	

TCS 102-108/10956/10960/18



TCS



530 x 350 x 55 mm, 18 pieces

Code		g
96 83 06 20		3653
No 102	150 mm	
No 103	150 mm	
No 105	120 x 10 mm	
No 108	150 x 2.5; 150 x 3; 150 x 4; 150 x 5; 150 x 6; 150 x 8 mm	
No 10956	∅ 50 mm	
No 10960	300; 500 g	
No 10356		
No 10670	285 mm	
No 10672	20 x 315 mm	
No 12374		
No 12900N		
No 12965N		

TCS 11095-13110/8



TCS



175 x 350 x 40 mm, 8 pieces

Code		g
96 83 87 89		700
No 12000	ISO	
No 11095/20	0.05 - 1.00 mm	
No 12935/3	3 m	
No 12321		
No 12322		
No 12665/52	0.25 - 6 mm	
No 12900		
No 13110	300 mm	

TCS 10356-12965/5

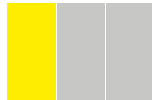

TCS



175 x 350 x 40 mm, 5 pieces

Code		g
96 83 87 90		610
No 12053	158 mm	
No 10356	40 mm	
No 10356R	10 pieces	
No 12320		
No 12965		

TCS 12025-13110/11



TCS



530 x 350 x 35 mm, 11 pieces

Code		g
96 83 87 59		2070
No 12025	210 mm	
No 12030	260 mm	
No 12035	210 mm	
No 12036	260 mm	
No 12050	300 mm	
No 12320		
No 12321		
No 12718		
No 12935/3	3 m	
No 12965N		
No 13110	300 mm	

TCS 1/3 MF

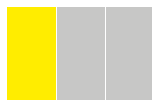

TCS



175 x 350 x 30 mm, empty inlay

Code		g
83 82 03 60		30

1

It's the first impression that counts. Point-of-sale system solutions.



When the new POS system was being developed, there was one main focal point: to generate the greatest possible benefit for the trade. The high-grade, visually appealing system features numerous sophisticated details designed to make life easier for the trade – and boost sales. Thanks to its modular construction, finely tuned down to the last detail, it can be individually adapted to any showroom arrangement. Efficient, high-quality, sophisticated. Typical for STAHLWILLE.

1 Good looking

The slanted top-mounted signs are effective eye-catchers and can be fitted and changed in seconds – thanks to the convenient magnetic construction.



You can find more details on the POS system in our special POS brochure – visit www.stahlwille.de/broschueren-und-flyer/en/stahlwille-pos.pdf



2 High-quality visual impact

All the base units of the POS system are in anthracite grey RAL 7016. This visual appearance emphasises the premium quality inherent in all STAHLWILLE tools. A further highlight (literally) is the integrated lighting.

3 Extensive range of accessories

The broad range of accessories available for the system makes it easy to fine-tune it on-site if needed. There are also specially designed holders for ratchets, extensions and many more items.

4 Quality round perforations

The perforated panels for attaching the product holders feature round holes. This avoids the visual distraction of the keyhole design found elsewhere.

5 Flexible storage space

Variable shelving and drawer elements are available to round off the presentation.



Quick change.

High-quality product and unique selling points (USP) panels - quickly interchangeable thanks to convenient magnetic backing.



Quickly assembled.

Step-by-step video guidance - to ensure uncomplicated, smooth assembly - visit www.stahlwille.de/videos/pos-assembly

Overview of the base modules.

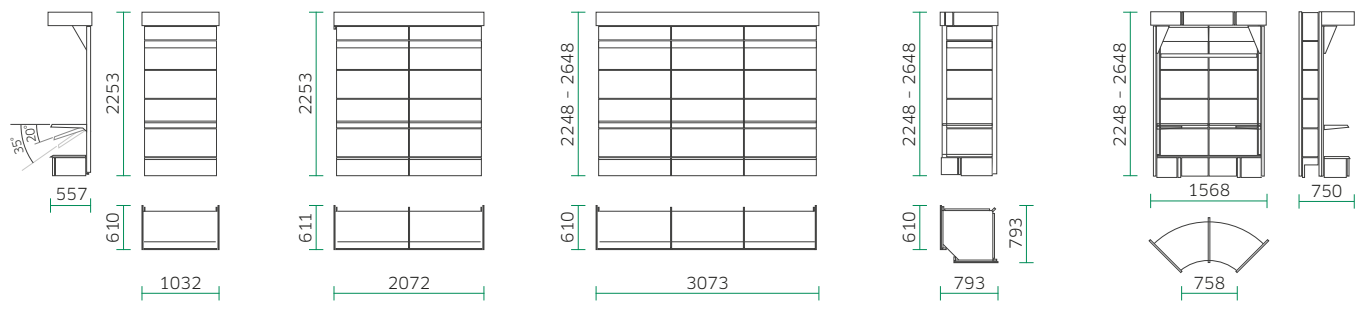

1M SYSTEM

2M SYSTEM

3M SYSTEM

CORNER WALL SYSTEM

CURVED BACK WALL SYSTEM



2 | SPANNERS

DOUBLE OPEN ENDED SPANNERS

→ PAGE 78



COMBINATION SPANNERS

→ PAGE 80



DOUBLE ENDED RING SPANNERS

→ PAGE 85



DOUBLE ENDED OPEN RING SPANNERS

→ PAGE 89



RATCHET WRENCHES

→ PAGE 90



DOUBLE ENDED FLEXI-JOINT SPANNERS

→ PAGE 92



HEAVY DUTY RING SPANNERS

→ PAGE 93



STRIKING FACE RING SPANNERS

→ PAGE 94



STRIKING FACE OPEN ENDED SPANNERS

→ PAGE 95



SINGLE-END SPANNERS

→ PAGE 95



BOX SPANNERS

→ PAGE 96





Strong, extremely tough and durable. **STAHLWILLE spanners**

2

1

Conventional spanners

When force is applied to a spanner, the greatest force acts on the joint between the jaw and the shaft. Standard-quality open-jaw spanners do not take this fact into consideration. In the context of normal hard work, this can lead to the tool breaking, causing considerable personal injury.

STAHLWILLE spanners

To reduce the danger of breakage, we add more material where the greatest loads are to be found and take it away from the places that are not under such stress. In this way, we are able to manufacture extremely sturdy, slim and light tools which also facilitate working in confined spaces due to their compact designs.

2

Extremely resilient, remarkably durable

- Drop-forged from high-grade special steels.
- Optimum hardening in continuous furnaces with no scale build-up or skin decarburisation.
- Gentle quenching in oil.

3

Light and easy to handle

- High resistance to bending and low weight thanks to STAHLWILLE's typical double-T profile.
- Snug-fitting, skin-friendly surfaces thanks to STAHLWILLE's rounded finish.

4

Key benefits when tightening and loosening screws

- Tougher than any bolt thanks to the forged double hex.
- Thinner than conventional rings - facilitating work in confined spaces.
- Higher than standard nuts - prevents the spanner jamming on the nut.

5

Quality assured

STAHLWILLE's Quality Assurance System was awarded an internationally recognised certificate in accordance with DIN ISO 9001 by the DQS (German Association for the Certification of Quality Assurance Systems).



Reproducible and identical -
tailored and perfectly
chrome-plated over nickel,
non-flaking finish



N-m Test results STAHLWILLE combination spanners No 13 (open-jaw)

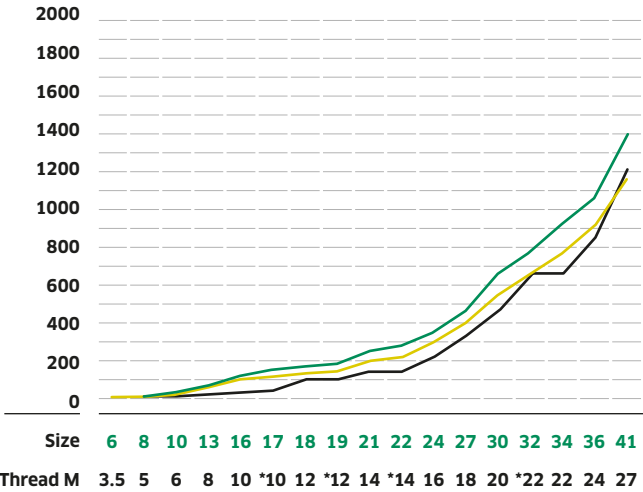

— Test results for STAHLWILLE
 — Test results to DIN 899 or ISO 1711
 — Clamping torque for 8.8 fasteners at 100% tensile yield strength ($\mu = 0.14$)
 *Reference to older screw thread standards



N-m Test results STAHLWILLE combination spanners No 13 (ring)

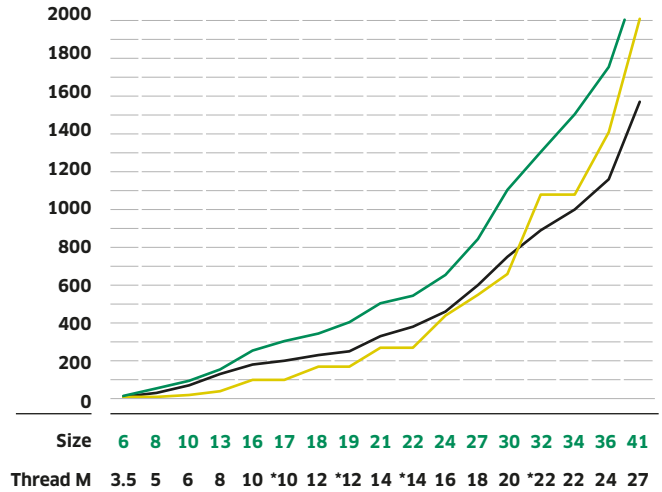

— Test results for STAHLWILLE
 — Test results to DIN 899 or ISO 1711
 — Clamping torque for 12.9 fasteners at 100% tensile yield strength ($\mu = 0.14$)



1 Load zones in standard-quality spanners

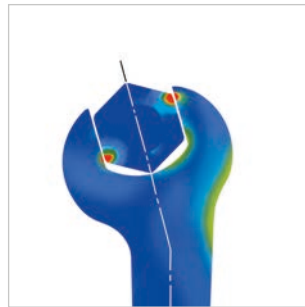

2 Load zones in spanners by STAHLWILLE

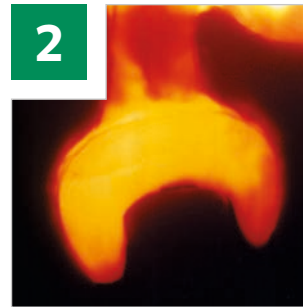

3 Open-jaw spanners in oil



4 Resistant to bending thanks to the double-T profile



5 Snug-fitting, skin-friendly surfaces thanks to STAHLWILLE's rounded finish

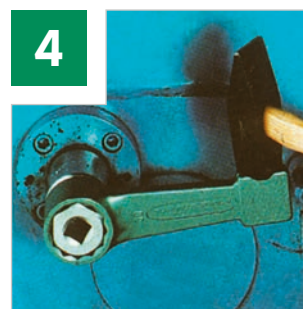

6 STAHLWILLE No 8 striking face double hex box-spanners are tougher, thinner and higher.

Spanners

10 Double open ended spanners

DIN 3110, ISO 10102 (metric sizes), Chrome Alloy Steel, chrome plated.

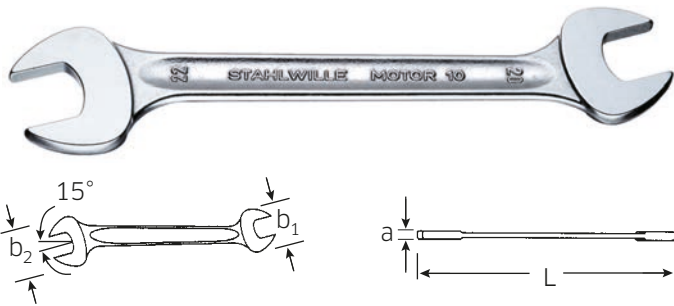

Code	Size mm	L mm	b ₁ mm	b ₂ mm	a mm	Weight g	Box
40030405	4 x 5	100	12.5	14	3.4	11	10
40035507	5.5 x 7	120	14.8	17	3.7	19	10
40030607	6 x 7	120	15.5	17	3.7	17	10
40030708	7 x 8	140	17	18	4.0	25	10
40030809	8 x 9	140	18	21	4.0	21	10
40030810	8 x 10	140	18	23	4.5	33	10
40031011	10 x 11	155	23	26	4.8	40	10
40031012	10 x 12	170	23	28	5.3	51	10
40031013	10 x 13	170	23	30	5.3	57	10
40031113	11 x 13	170	26	30	5.3	55	10
40031213	12 x 13	170	28	30	5.3	64	10
40031214	12 x 14	170	28	32	5.3	63	10
40031314	13 x 14	190	30	32	5.3	70	10
40031315	13 x 15	190	30	35	5.3	73	10
40031317	13 x 17	205	30	38	5.8	92	10
40031415	14 x 15	190	32	35	5.3	81	10
40031417	14 x 17	205	32	38	5.8	99	10
40031617	16 x 17	205	36	38	5.8	100	10
40031618	16 x 18	220	36	40	6.7	125	10
40031719	17 x 19	220	38	42	6.7	131	10
40031819	18 x 19	220	40	42.5	6.7	147	10
40031821	18 x 21	235	40	47	7.3	170	10
40031922	19 x 22	235	42	49	7.3	179	10
40032022	20 x 22	235	45	49	7.3	185	10
40032123	21 x 23	250	47	51	7.8	225	5
40032124	21 x 24	250	47	53	7.8	215	5
40032224	22 x 24	250	49	53	7.8	232	5
40032426	24 x 26	270	53	57.5	8.3	293	5
40032427	24 x 27	280	53	60	8.3	299	5
40032528	25 x 28	285	55	62	8.3	309	5
40032730	27 x 30	300	60	66	9.4	412	5
40032732	27 x 32	300	60	70	9.4	418	5
40033032	30 x 32	300	66	70	9.4	451	5
40033034	30 x 34	300	66	75	9.4	480	5
40033236	32 x 36	325	70	80	10	546	5
40033436	34 x 36	325	75	80	10	619	1
40033641	36 x 41	375	80	88	11	800	1
40034146	41 x 46	425	88	94.5	12	1030	1

10a Double open ended spanners

Code	Size	L mm	b ₁ mm	b ₂ mm	a mm	Weight g	Box
40431620	1/4 x 5/16	140	16	18	4	21	10
40432024	5/16 x 3/8	140	18	23	4.5	34	10
40432428	3/8 x 7/16	155	23	26	4.8	48	10
40432832	7/16 x 1/2	170	26	30	5.3	58	10
40433234	1/2 x 9/16	190	30	32	5.3	73	10
40433436	9/16 x 5/8	205	32	36	5.8	96	10
40433538	19/32 x 11/16	205	35	40	5.8	105	10
40433638	5/8 x 11/16	205	36	40	5.8	101	10
40433640	5/8 x 3/4	220	36	42	6.7	135	10
40433840	11/16 x 3/4	220	40	42	6.7	135	10
40433842	11/16 x 13/16	235	40	47	7.3	167	10
40434044	3/4 x 7/8	235	42	49	7.3	177	10
40434142	25/32 x 13/16	235	45	47	7.3	190	10
40434446	7/8 x 15/16	250	49	53	7.8	235	10
40434648	15/16 x 1	270	53	55	8.3	303	5
40435258	1 1/8 x 1 5/16	300	64	75	9.4	502	5

10, 10a Sets: Double open ended spanners, in roll-up wallet

Roll-up wallet made of extremely tough textile with Velcro fastener.



Code	No	Content mm/"	Weight g
96400304	10/5 NEW	8 x 9; 10 x 11; 12 x 13; 14 x 15; 17 x 19	490
96400305	10/8	6 x 7; 8 x 9; 10 x 11; 12 x 13; 14 x 15; 16 x 17; 18 x 19; 20 x 22	745
96400314	10/9 ¹⁾	6 x 7; 8 x 9; 10 x 11; 12 x 13; 14 x 15; 16 x 17; 18 x 19; 20 x 22; 21 x 24	918
96400307	10/10	6 x 7; 8 x 9; 10 x 11; 12 x 13; 14 x 15; 16 x 17; 18 x 19; 20 x 22; 24 x 27; 30 x 32	1540
96400306	10/12	6 x 7; 8 x 9; 10 x 11; 12 x 13; 14 x 15; 16 x 17; 18 x 19; 20 x 22; 21 x 23; 24 x 27; 25 x 28; 30 x 32	2125
96404306	10a/7	1/4 x 5/16; 3/8 x 7/16; 1/2 x 9/16; 5/8 x 3/4; 11/16 x 13/16; 7/8 x 15/16; 1 1/8 x 1 5/16	1242
96404307	10a/11	1/4 x 5/16; 3/8 x 7/16; 1/2 x 9/16; 9/16 x 5/8; 19/32 x 11/16; 5/8 x 3/4; 11/16 x 13/16; 3/4 x 7/8; 25/32 x 13/16; 7/8 x 15/16; 1 1/8 x 1 5/16	1870

¹⁾ packed in carton

ES 10/10, 5.5x7-22x24 mm



175 x 350 x 60 mm, 10 pieces

Code	Weight g
96838130	1100
No 10	sizes 5.5 x 7; 8 x 10; 10 x 12; 11 x 13; 12 x 14; 14 x 17; 17 x 19; 18 x 21; 19 x 22; 22 x 24 mm
83812033	Empty tray 106

Made in Germany

ES 10/10, 6x7-30x32 mm



175 x 350 x 70 mm, 10 pieces

Code	Δ	g
96838126		1515
No 10	sizes 6 x 7; 8 x 9; 10 x 11; 12 x 13; 14 x 15; 16 x 17; 18 x 19; 20 x 22; 24 x 27; 30 x 32 mm	
83812022	Empty tray	112

TCS 10/10, 6x7-30x32 mm



TCS



350 x 350 x 30 mm, 10 pieces

Code	Δ	g
96838182		1550
No 10	sizes 6 x 7; 8 x 9; 10 x 11; 12 x 13; 14 x 15; 16 x 17; 18 x 19; 20 x 22; 24 x 27; 30 x 32 mm	

TCS 10/10, 6x7-30x32 mm MF

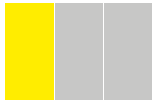

TCS



175 x 350 x 75 mm, 10 pieces

Code	Δ	g
96830353		1437
No 10	sizes 6 x 7; 8 x 9; 10 x 11; 12 x 13; 14 x 15; 16 x 17; 18 x 21; 19 x 22; 24 x 27; 30 x 32 mm	

TCS 10/10, 6x7-24x27 mm



TCS



175 x 350 x 66 mm, 10 pieces

Code	Δ	g
96838187		1287
No 10	sizes 6 x 7; 8 x 9; 10 x 11; 12 x 13; 14 x 15; 16 x 17; 18 x 19; 20 x 22; 21 x 24; 24 x 27 mm	

TCS 10/10, 6x7-24x27 mm MF

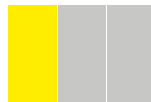

TCS



175 x 350 x 70 mm, 10 pieces

Code	Δ	g
96830358		1320
No 10	sizes 6 x 7; 8 x 9; 10 x 11; 12 x 13; 14 x 15; 16 x 17; 18 x 19; 20 x 22; 21 x 24; 24 x 27 mm	

TCS 10/11, 6x7-34x36 mm



TCS



175 x 350 x 82 mm, 11 pieces

Code	Δ	g
96830167		2056
No 10	sizes 6 x 7; 8 x 9; 10 x 11; 12 x 13; 14 x 15; 16 x 17; 18 x 21; 19 x 22; 24 x 27; 30 x 32; 34 x 36 mm	

TCS 10+13+24/30



TCS



530 x 350 x 75 mm, 30 pieces

Code	Δ	g
96830605		3724
No 10	sizes 6 x 7; 8 x 9; 10 x 11; 12 x 13; 14 x 15; 16 x 17; 18 x 19; 20 x 22; 21 x 24 mm	
No 13	sizes 6; 7; 8; 9; 10; 11; 12; 13; 14; 15; 16; 17; 18; 19; 21; 22; 24; 27; 30; 32 mm	
No 24	size 10 x 11 mm	

TCS 10a/9

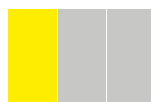

TCS



175 x 350 x 70 mm, 9 pieces

Code	Δ	g
96838779		1555
No 10a	sizes 1/4 x 5/16; 3/8 x 7/16; 1/2 x 9/16; 19/32 x 11/16; 5/8 x 3/4; 3/4 x 7/8; 25/32 x 13/16; 15/16 x 1; 1 1/8 x 1 5/16"	

Spanners

12 Small double open ended spanners ELECTRIC

Chrome Alloy Steel, chrome plated.

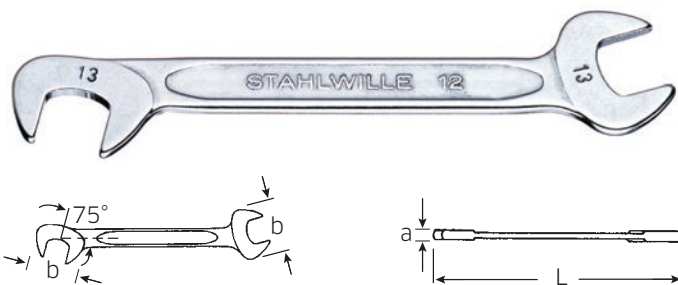

Code	Ø mm	L mm	b mm	a mm	Δ g	📦
4006 3232	3.2	70	10.5	2	5	10
4006 3535	3.5	70	10.5	2	5	10
4006 0404	4	70	10.5	2	5	10
4006 4545	4.5	70	10.5	2	5	10
4006 0505	5	78	12.6	2	7	10
4006 5555	5.5	78	12.6	2	7	10
4006 0606	6	78	12.6	2	6	10
4006 0707	7	91	14.7	2	9	10
4006 0808	8	96	16.8	3	16	10
4006 0909	9	103	18.9	3	19	10
4006 1010	10	105	21	3	22	10
4006 1111	11	116	24.2	3	27	10
4006 1212	12	116	24.2	3	27	10
4006 1313	13	131	28.3	3	37	10
4006 1414	14	131	28.3	3	36	10

12a Small double open ended spanners ELECTRIC

Code	Ø"	L mm	b mm	a mm	Δ g	📦
4046 1010	5/32	70	10.5	2	5	10
4046 1212	3/16	70	10.5	2	5	10
4046 1313	13/64	78	12.6	2	7	10
4046 1414	7/32	78	12.6	2	6	10
4046 1515	15/64	78	12.6	2	6	10
4046 1616	1/4	91	14.7	2	9	10
4046 1818	9/32	91	14.7	2	9	10
4046 2020	5/16	96	16.8	3	16	10
4046 2222	11/32	103	18.9	3	19	10
4046 2424	3/8	105	21	3	22	10
4046 2828	7/16	116	24.2	3	28	10
4046 3232	1/2	131	28.3	3	37	10
4046 3434	9/16	131	28.3	3	36	10

12, 12a Sets: Small double open ended spanners ELECTRIC, in roll-up wallet

Roll-up wallet made of extremely tough textile with Velcro fastener.



Code	No	Content mm/"	Δ g
96 40 06 53	12/10	4; 4.5; 5; 5.5; 6; 7; 8; 9; 10; 11	161
96 40 06 51	12/15	3.2; 3.5; 4; 4.5; 5; 5.5; 6; 7; 8; 9; 10; 11; 12; 13; 14	296
96 40 46 54	12a/13	5/32; 3/16; 13/64; 7/32; 15/64; 1/4; 9/32; 5/16; 11/32; 3/8; 7/16; 1/2; 9/16	270

13 Combination spanners OPEN-BOX



DIN 3113 form A/ISO 7738 form A (metric sizes), Chrome Alloy Steel, chrome plated.

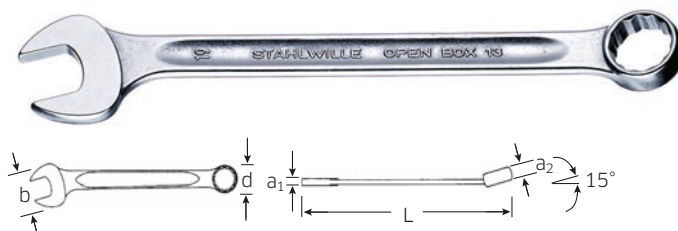

Code	Ø mm	L mm	b mm	d mm	a ₁ mm	a ₂ mm	Δ g	📦
4008 5500	5.5	100	14.8	9.2	3.5	5.8	13	10
4008 0606	6	105	15.5	9.9	3.6	6	15	10
4008 0707	7	110	17	11.3	3.9	6	20	10
4008 0808	8	115	18	12.4	4.2	7	21	10
4008 0909	9	120	21	13.4	4.5	7	27	10
4008 1010	10	125	23	14.8	4.8	7	35	10
4008 1111	11	135	26	16.4	4.8	8	43	10
4008 1212	12	140	28	17.8	5.3	8.5	46	10
4008 1313	13	160	30	19.1	5.3	8.5	57	10
4008 1414	14	165	32	20.6	5.3	8.5	68	10
4008 1515	15	170	35	21.9	5.3	8.5	73	10
4008 1616	16	180	37	23.2	5.8	10	89	10
4008 1717	17	190	38	24.6	5.8	10	99	10
4008 1818	18	200	40	26	6.7	11.5	126	10
4008 1919	19	230	42	27.5	6.7	11.5	142	10
4008 2020	20	230	45	29	7	13	176	10
4008 2121	21	260	47	30.3	7.3	13	216	10
4008 2222	22	260	49	31.8	7.3	13	220	10
4008 2323	23	280	53	33.5	7.8	14	251	5
4008 2424	24	280	53	34.9	7.8	14	254	5
4008 2525	25	300	55	36.3	8.4	14.5	281	5
4008 2626	26	300	57.5	37.8	8.4	14.5	315	5
4008 2727	27	300	60	39.2	8.4	14.5	345	5
4008 2828	28	320	62	40.6	8.4	14.5	368	5
4008 2929	29	330	64	41.9	8.9	16	420	5
4008 3030	30	330	66	43.2	8.9	16	404	5
4008 3232	32	360	70	45.8	9.4	16.5	484	5
4008 3434	34	450	75	48	9.4	17	683	1
4008 3636	36	460	80	50.8	10	18	787	1
4008 3838	38	480	87	53.6	11	19	915	1
4008 4141	41	480	88	57.8	11	19	1055	1
4008 4646	46	500	94.5	65.2	13	20	1352	1
4008 5050	50	530	103	73	14	21	1700	1
4008 5555	55	560	114	81	15	22	2193	1
4008 6060	60	590	125	89.8	16	24	2825	1

STAHLWILLE »AS-Drive«

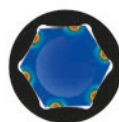

The rings of STAHLWILLE combination spanners and double ended ring spanners are equipped with the AS-Drive® profile: this permits high transmission of forces to the lands of nuts and bolts without damaging them. No longer will you have to worry about stripping the corners off nuts and bolts.

*Anti-Slip-Drive

13a Combination spanners OPEN-BOX

Code	⌀ "	L mm	b mm	d mm	a ₁ mm	a ₂ mm	⊕ g	
40 48 12 12	3/16	95	14	9.8	3	3.2	10	5
40 48 13 13	13/64	95	14	9.8	3	3.2	10	5
40 48 14 14	7/32	95	14	9.8	3	3.2	10	5
40 48 15 15	15/64	95	14	9.8	3	3.2	9	5
40 48 16 16	1/4	105	15.5	10.2	3.6	6	14	10
40 48 18 18	9/32	110	17	11.3	3.9	6	17	10
40 48 20 20	5/16	115	18	12.4	4.2	7	20	10
40 48 22 22	11/32	120	21	13.4	4.5	7	26	10
40 48 24 24	3/8	125	23	14.3	4.8	7	32	10
40 48 28 28	7/16	135	26	16.4	4.8	8	41	10
40 48 32 32	1/2	160	30	18.8	5.3	8.5	57	10
40 48 34 34	9/16	165	32	20.6	5.3	8.5	68	10
40 48 35 35	19/32	170	35	21.9	5.3	8.5	74	10
40 48 36 36	5/8	180	37	23.2	5.8	10	88	10
40 48 38 38	11/16	200	40	25.3	6.7	11.5	116	10
40 48 40 40	3/4	230	42	27.5	6.7	11.5	144	10
40 48 41 41	25/32	235	45	29	7	13	175	5
40 48 42 42	13/16	260	47	30	7.3	13	204	5
40 48 44 44	7/8	260	49	31.8	7.3	13	217	5
40 48 46 46	15/16	280	53	34.9	7.8	14	255	5
40 48 48 48	1	300	55	37.2	8.4	14.5	286	5
40 48 50 50	1 1/16	300	60	39.2	8.4	14.5	327	5
40 48 52 52	1 1/8	330	64	41.4	8.9	16	380	5
40 48 54 54	1 3/16	332	66	43.2	8.9	16.5	398	1
40 48 56 56	1 1/4	360	70	45.8	9.4	16.5	504	5
40 48 58 58	1 5/16	450	74	47	9.6	17	617	1
40 48 60 60	1 3/8	460	80	49.3	10	18	796	1
40 48 62 62	1 7/16	461	80	51.4	10	18	770	1
40 48 64 64	1 1/2	480	87	53.6	11	19	961	1
40 48 66 66	1 5/8	480	88	58	11	19	1021	1
40 48 69 69	1 13/16	500	94.5	65.3	13	20	1343	1
40 48 70 70	1 7/8	530	103	68.4	14	21	1779	1
40 48 72 72	2	530	103	74	14	21	1817	1

13, 13a Sets: Combination spanners OPEN-BOX



Code	No	Content mm/"	⊕ g
96 40 08 13	13/6	7; 8; 10; 13; 17; 19	430
96 40 08 01	13/9	9; 10; 11; 12; 13; 14; 17; 19; 22	758
96 40 08 08	13/10KT ¹⁾	8; 9; 10; 11; 12; 13; 14; 15; 17; 19	746
96 40 08 02	13/11	8; 9; 10; 11; 12; 13; 14; 15; 17; 19; 22	915
96 40 08 03	13/15	6; 7; 8; 9; 10; 11; 12; 13; 17; 19; 22; 24; 27; 30; 32	2236
96 40 08 16	13/16 ²⁾	7; 8; 9; 10; 11; 12; 13; 14; 15; 16; 17; 18; 19; 21; 22; 24	1620
96 40 08 04	13/17	6; 7; 8; 9; 10; 11; 12; 13; 14; 15; 16; 17; 18; 19; 20; 21; 22	1480
96 40 08 05	13/26 ²⁾	6; 7; 8; 9; 10; 11; 12; 13; 14; 15; 16; 17; 18; 19; 20; 21; 22; 23; 24; 25; 26; 27; 28; 29; 30; 32	4705
96 40 48 03	13a/8 ²⁾	7/16; 1/2; 9/16; 5/8; 11/16; 3/4; 13/16; 7/8	959
96 40 48 12	13a/10KT ¹⁾	1/4; 5/16; 11/32; 3/8; 7/16; 1/2; 9/16; 5/8; 11/16; 3/4	750
96 40 48 04	13a/20 ²⁾	1/4; 9/32; 5/16; 11/32; 3/8; 7/16; 1/2; 9/16; 19/32; 5/8; 11/16; 3/4; 25/32; 13/16; 7/8; 15/16; 1; 1 1/16; 1 1/8; 1 1/4	3210

Standard packing: Roll-up wallet made of extremely tough textile with Velcro fastener.

¹⁾ carton with clear view cover

²⁾ packed in carton

ES 13/10, 6-15 mm

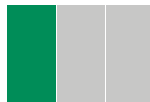

175 x 350 x 40 mm, 10 pieces

Code	⊕ g
96 83 81 27	525
No 13	sizes 6; 7; 8; 9; 10; 11; 12; 13; 14; 15 mm
83 81 20 23	Empty tray 105

ES 13/8, 16-24 mm



175 x 350 x 54 mm, 8 pieces

Code	⊕ g
96 83 81 28	1440
No 13	sizes 16; 17; 18; 19; 20; 21; 22; 24 mm
83 81 20 24	Empty tray 112

ES 13/5, 27-32 mm



530 x 350 x 30 mm, 5 pieces

Code	⊕ g
96 83 81 04	2280
No 13	sizes 27; 28; 29; 30; 32 mm
83 81 20 40	Empty tray 287

TCS 13/18, 6-24 mm

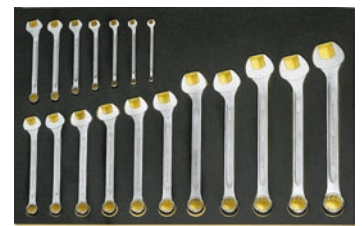

530 x 350 x 35 mm, 18 pieces

Code	⊕ g
96 83 81 83	1850
No 13	sizes 6; 7; 8; 9; 10; 11; 12; 13; 14; 15; 16; 17; 18; 19; 20; 21; 22; 24 mm

Spanners

2

TCS 13/17, 6-24 mm



TCS

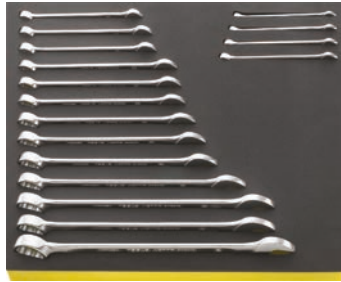

350 x 350 x 60 mm, 17 pieces

Code

96830164

ΔΔ
g

1615



No 13

sizes 6; 7; 8; 9; 10; 11; 12; 13; 14; 15;
16; 17; 18; 19; 21; 22; 24 mm

TCS 13/17, 6-24 mm MF



TCS



350 x 350 x 60 mm, 17 pieces

Code

96830351

ΔΔ
g

1552



No 13

sizes 6; 7; 8; 9; 10; 11; 12; 13; 14; 15;
16; 17; 18; 19; 21; 22; 24 mm

TCS 13/21, 6-34 mm



TCS



530 x 350 x 75 mm, 21 pieces

Code

96830174

ΔΔ
g

3571



No 13

sizes 6; 7; 8; 9; 10; 11; 12; 13; 14; 15;
16; 17; 18; 19; 21; 22; 24; 27; 30; 32;
34 mm

TCS 13/25, 5.5-34 mm



TCS



530 x 350 x 80 mm, 25 pieces

Code

96832096

ΔΔ
g

4550



No 13

sizes 5,5; 6; 7; 8; 9; 10; 11; 12; 13; 14;
15; 16; 17; 18; 19; 20; 21; 22; 23; 24;
27; 29; 30; 32; 34 mm

TCS 12+13+14/29



TCS



530 x 350 x 80 mm, 29 pieces

Code

96830193

ΔΔ
g

3752



No 12

sizes 5,5; 12; 14 mm (2x)



No 13

sizes 7; 11 mm (2x);
sizes 6; 8; 9; 10; 12; 13; 14; 15; 16; 17;
18; 19; 20; 22; 24; 30; 32; 36 mm (1x)



No 14

size 17 mm

TCS 13a/19



TCS



350 x 350 x 55 mm, 19 pieces

Code

96838778

ΔΔ
g

2000



No 13a

sizes 3/16; 7/32; 1/4; 9/32; 5/16; 11/32; 3/8;
7/16; 1/2; 9/16; 19/32; 5/8; 11/16; 3/4; 25/32;
13/16; 7/8; 15/16; 1"



TCS 13a/23



TCS



530 x 350 x 35 mm, 23 pieces

Code	Δ g
96 83 08 85	2726

No 13a	sizes 3/16; 13/64; 7/32; 15/64; 1/4; 9/32; 5/16; 11/32; 3/8; 7/16; 1/2; 9/16; 19/32; 5/8; 11/16; 3/4; 25/32; 13/16; 7/8; 15/16; 1; 1 1/16; 1 1/8"
---------------	---

130a Combination spanners

AS DRIVE HPQ

Fed. Spec. GGG-W-636 E, HPQ® high performance steel, chrome plated.

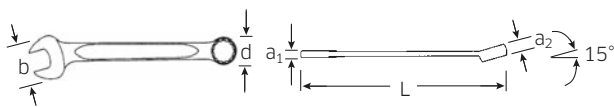

Code	Δ "	L mm	b mm	d mm	a ₁ mm	a ₂ mm	Δ g	
40 57 16 16	1/4	105	14.2	9.8	3.6	6	13	10
40 57 18 18	9/32	110	15.5	10.9	4.1	6	16	10
40 57 20 20	5/16	115	17	12	4.5	7	20	10
40 57 22 22	11/32	120	19	13.1	4.9	7	25	10
40 57 24 24	3/8	125	20.5	14.1	5.2	7	32	10
40 57 28 28	7/16	135	23	16.2	6	8	42	10
40 57 32 32	1/2	150	27	18.2	6.5	8.5	61	10
40 57 34 34	9/16	165	30.5	20.6	7	8.5	78	10

130aSP Spline drive combination spanners

HPQ

MS-33787, MIL-W-8982, HPQ® high performance steel, chrome plated.

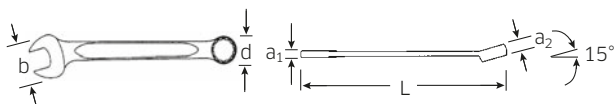

Code	Spline size	Δ "	L mm	b mm	d mm	a ₁ mm	a ₂ mm	Δ g	
40 58 16 16	8	1/4	105	14.2	10	3.6	5.6	13	5
40 58 20 20	10	5/16	115	17	12.2	4.5	6.4	21	5
40 58 24 24	12	3/8	125	20.5	14.8	5.2	7	31	5
40 58 28 28	14	7/16	135	23	16.5	6	8	43	5
40 58 32 32	16	1/2	150	27	18.7	6.5	8.5	59	5
40 58 34 34	18	9/16	165	30.5	20.8	7	8.5	84	5

14 Combination spanners OPEN-BOX, long

AS DRIVE

DIN 3113 form B/ ISO 7738 form B, Chrome Alloy Steel, chrome plated.

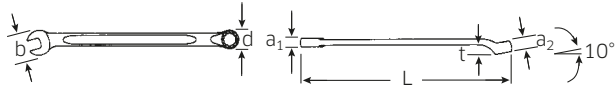

Code	Δ mm	L mm	b mm	d mm	a ₁ mm	a ₂ mm	t mm	Δ g	
40 10 06 06	6	125	14	9.5	4.5	6	7	18	10
40 10 07 07	7	135	16	10.8	5	7	8	25	10
40 10 08 08	8	145	17.5	12.1	5	7	8	28	10
40 10 09 09	9	155	19	13.3	5.5	8	9	34	10
40 10 10 10	10	165	21	14.6	5.5	8	9	43	10
40 10 11 11	11	180	23.5	15.9	6	9	10	55	10
40 10 12 12	12	180	25.5	17.3	6	9	10	61	10
40 10 13 13	13	195	27.5	18.6	6.5	10	11	83	10
40 10 14 14	14	210	29.5	20.1	6.5	10	11	88	10
40 10 15 15	15	215	31	21.4	7	11	13	109	10
40 10 16 16	16	230	33	22.7	7	11	14	108	10
40 10 17 17	17	240	35	24.1	7.5	12	15	151	10
40 10 18 18	18	255	37	25.5	7.5	12	16	151	10
40 10 19 19	19	265	39.5	27	8	13	18	190	10
40 10 20 20	20	280	41.5	28.5	8	13	19	219	10
40 10 21 21	21	280	43	29.8	8.5	13	19	244	10
40 10 22 22	22	300	45	31.3	8.5	14	20	268	10
40 10 24 24	24	330	50	34.3	9.5	14	22	363	5
40 10 27 27	27	385	56	38.6	10.5	16	24	502	5
40 10 30 30	30	415	63	42.6	12	18	26	645	5
40 10 32 32	32	430	67	45.2	12	18	27	666	5
40 10 34 34	34	460	72	48	13	18	27	900	1
40 10 36 36	36	480	74	50.8	13	19	28	951	1
40 10 41 41	41	560	84	57.8	14	20	32	1322	1

14 Sets: Combination spanners OPEN-BOX, long



Code	No	Content mm	Δ g
96 40 10 08	14/6¹⁾	10; 13; 17; 19; 22; 24	1175
96 40 10 09	14/9²⁾	10; 11; 13; 17; 19; 22; 24; 27; 30	2395
96 40 10 07	14/10 KT¹⁾	8; 10; 11; 12; 13; 14; 16; 17; 18; 19	1235
96 40 10 06	14/11	8; 9; 10; 11; 12; 13; 14; 15; 17; 19; 22	1131
96 40 10 04	14/15	6; 7; 8; 9; 10; 11; 12; 13; 17; 19; 22; 24; 27; 30; 32	3370
96 40 10 10	14/15N²⁾	10; 11; 12; 13; 14; 15; 16; 17; 18; 19; 21; 22; 24; 27; 30	3165
96 40 10 05	14/17	6; 7; 8; 9; 10; 11; 12; 13; 14; 15; 16; 17; 18; 19; 20; 21; 22	1874

Standard packing: Roll-up wallet made of extremely tough textile with Velcro fastener.

¹⁾ packed in plastic with transparent cover

²⁾ packed in carton

Spanners

ES 14/10, 6-15 mm



175 x 350 x 39 mm, 10 pieces

Code	g
96838105	700
No 14	sizes 6; 7; 8; 9; 10; 11; 12; 13; 14; 15 mm
83812034 Empty tray	110

ES 14/8, 16-24 mm



175 x 350 x 51 mm, 8 pieces

Code	g
96838106	1820
No 14	sizes 16; 17; 18; 19; 20; 21; 22; 24 mm
83812035 Empty tray	112

TCS 14/5, 17-21 mm

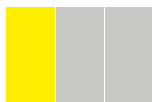

TCS



175 x 350 x 30 mm, 5 pieces

Code	g
96838188	1065
No 14	sizes 17; 18; 19; 20; 21 mm

TCS 14/8, 8-16 mm

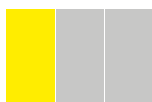

TCS



175 x 350 x 30 mm, 8 pieces

Code	g
96838189	660
No 14	sizes 8; 10; 11; 12; 13; 14; 15; 16 mm

TCS 14/18, 6-24 mm



TCS



350 x 350 x 60 mm, 18 pieces

Code	g
96838750	2600
No 14	sizes 6; 7; 8; 9; 10; 11; 12; 13; 14; 15; 16; 17; 18; 19; 20; 21; 22; 24 mm

TCS 14/21, 6-36 mm



TCS



530 x 350 x 75 mm, 21 pieces

Code	g
96838771	5100
No 14	sizes 6; 7; 8; 9; 10; 11; 12; 13; 14; 15; 16; 17; 18; 19; 21; 22; 24; 27; 30; 32; 36 mm

Tool Control System

The safety inlay system

- Designed to fit our Tool Trolleys and Tool Boxes
- With yellow signal cut-outs to show whether all tools are in their places

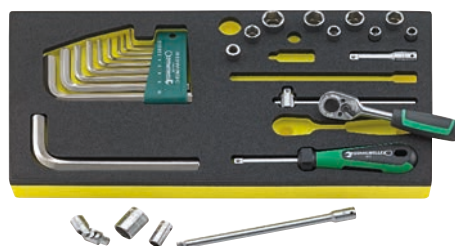

TCS

4014 Combination spanners

Chrome-Vanadium, chrome plated.



Code	mm	L mm	b mm	d mm	a ₁ mm	a ₂ mm	t mm	g	Box
40 14 65 65	65	710	133	98	22	33	49.5	4500	1
40 14 70 70	70	760	143	105	24	35	53.5	5500	1
40 14 75 75	75	810	153	110	26	38	57.5	6500	1
40 14 80 80	80	860	163	119	28	41	63.5	8000	1

16 Combination spanners OPEN-BOX

ISO 3318, Chrome Alloy Steel, chrome plated.



Code	mm	L mm	b mm	d mm	a ₁ mm	a ₂ mm	g	Box
40 09 32 32	3.2	75	10	6.6	3	3.2	6	10
40 09 35 35	3.5	75	10	6.6	3	3.2	6	10
40 09 40 40	4	85	12.5	7.8	3	3.2	9	10
40 09 45 45	4.5	85	12.5	7.8	3	3.2	8	10
40 09 50 50	5	95	14	9.8	3	3.2	11	10

16/5 Set: Combination spanners OPEN-BOX; 3.2-5 mm, in textile bag



Code	Content mm	g
96 40 09 02	3.2; 3.5; 4; 4.5; 5	46

20 Double ended ring spanners



StahlwilleSTABIL®

offset, DIN 838/ISO 10104 (metric sizes), Chrome Alloy Steel, chrome plated.

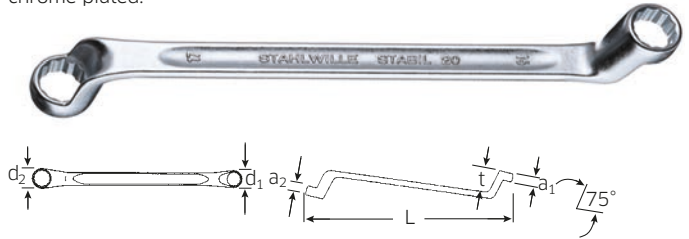

Code	mm	L mm	d ₁ mm	d ₂ mm	a ₁ mm	a ₂ mm	t mm	g	Box
41 04 06 07	6 x 7	165	10.5	11.8	6	7	18	46	10
41 04 08 09	8 x 9	180	13.1	14.5	7	8	20	62	10
41 04 08 10	8 x 10	180	13.1	15.8	7	9	21	61	10
41 04 10 11	10 x 11	200	15.8	17.2	9	9	23	93	10
41 04 10 13	10 x 13	220	15.8	20	9	10	25	122	10
41 04 12 13	12 x 13	220	18.6	20	9	10	25	126	10
41 04 13 17	13 x 17	245	20	25.3	10	12	27	169	10
41 04 14 15	14 x 15	245	21.3	22.6	10	12	27	163	10
41 04 16 17	16 x 17	255	23.9	25.3	11	12	27	181	10
41 04 17 19	17 x 19	270	25.3	28	12	13	29	220	10
41 04 18 19	18 x 19	275	26.6	28	12	13	29	228	10
41 04 18 21	18 x 21	300	26.6	30.7	12	13	31	279	10
41 04 19 22	19 x 22	300	28	32.1	13	14	31	315	10
41 04 20 22	20 x 22	300	29.4	32.1	13	14	31	317	5
41 04 21 23	21 x 23	315	30.7	33.4	13	14	31	312	5
41 04 21 24	21 x 24	330	30.7	34.7	13	14	34	384	5
41 04 22 24	22 x 24	330	32.1	34.7	14	14	34	368	5
41 04 24 26	24 x 26	330	34.7	37.3	14	15	34	427	5
41 04 24 27	24 x 27	330	34.7	38.6	14	15	34	447	5
41 04 25 28	25 x 28	350	36	40	14	15	34	414	5
41 04 27 30	27 x 30	360	38.3	42.6	15	15	37	595	5
41 04 27 32	27 x 32	360	39.3	47.2	15	16	37	596	5
41 04 30 32	30 x 32	365	42.6	45.4	15	16	37	603	5
41 04 30 34	30 x 34	365	42.6	48	15	16	37	660	1
41 04 36 41	36 x 41	440	53	60	17	18	40	1015	1
41 04 46 50	46 x 50	535	65.2	73	19	20	45	1709	1

20a Double ended ring spanners

Code	mm	L mm	d ₁ mm	d ₂ mm	a ₁ mm	a ₂ mm	t mm	g	Box
41 44 16 20	1/4 x 5/16	180	11.8	13.1	7	7	20	61	10
41 44 24 28	3/8 x 7/16	200	15.8	17.2	9	9	23	88	10
41 44 32 34	1/2 x 9/16	220	20	21.3	9	10	25	131	10
41 44 34 36	9/16 x 5/8	245	21.3	25.3	10	12	27	168	10
41 44 35 38	19/32 x 11/16	255	23.9	25.3	11	12	27	177	10
41 44 36 40	5/8 x 3/4	270	23.9	28	12	13	29	235	10
41 44 38 42	11/16 x 13/16	300	25.3	30.7	12	13	31	280	5
41 44 40 44	3/4 x 7/8	300	28	32.1	13	14	31	299	5
41 44 41 42	25/32 x 13/16	300	29.4	32.1	13	14	31	333	5
41 44 44 46	7/8 x 15/16	330	32.1	34.7	14	14	34	363	5
41 44 46 48	15/16 x 1	330	34.7	37.3	14	15	34	419	5
41 44 52 58	1 1/8 x 1 5/16	365	42.6	45.4	15	16	37	581	1

20, 20a Sets: Double ended ring spanners

StahlwilleSTABIL®

offset.

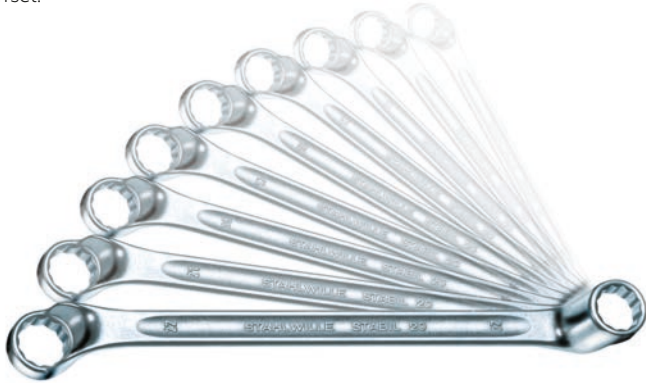

Code	No	Content mm/"	Δ g
96 41 04 08	20/7N	6 x 7; 8 x 9; 10 x 11; 12 x 13; 14 x 15; 16 x 17; 18 x 19;	930
96 41 04 05	20/8	6 x 7; 8 x 9; 10 x 11; 12 x 13; 14 x 15; 16 x 17; 18 x 19; 20 x 22	1220
96 41 04 09	20/9	6 x 7; 8 x 9; 10 x 11; 12 x 13; 14 x 15; 16 x 17; 18 x 19; 20 x 22; 21 x 24	1650
96 41 04 07	20/10	6 x 7; 8 x 9; 10 x 11; 12 x 13; 14 x 15; 16 x 17; 18 x 19; 20 x 22; 24 x 27; 30 x 32	2331
96 41 04 06	20/12	6 x 7; 8 x 9; 10 x 11; 12 x 13; 14 x 15; 16 x 17; 18 x 19; 20 x 22; 21 x 23; 24 x 27; 25 x 28; 30 x 32	3137
96 41 44 02	20a/6	1/4 x 5/16; 3/8 x 7/16; 1/2 x 9/16; 5/8 x 3/4; 11/16 x 13/16; 7/8 x 15/16	1244
96 41 44 05	20a/10	1/4 x 5/16; 3/8 x 7/16; 1/2 x 9/16; 9/16 x 5/8; 19/32 x 11/16; 5/8 x 3/4; 11/16 x 13/16; 3/4 x 7/8; 25/32 x 13/16; 7/8 x 15/16	2260

packed in carton

ES 20/8, 6x7-19x22 mm

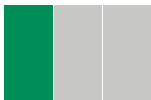

175 x 350 x 30 mm, 8 pieces

Code	Δ g
96 83 81 67	1266
No 20	sizes 6 x 7; 8 x 9; 10 x 11; 12 x 13; 14 x 15; 16 x 17; 18 x 21; 19 x 22 mm
83 81 20 83	103

ES 20/10, 6x7-30x32 mm



530 x 350 x 44 mm, 10 pieces

Code	Δ g
96 83 81 07	2620
No 20	sizes 6 x 7; 8 x 9; 10 x 11; 12 x 13; 14 x 15; 16 x 17; 18 x 19; 20 x 22; 24 x 27; 30 x 32 mm

83 81 20 44	Empty tray	309
-------------	------------	-----

TCS 20/8, 6x7-19x22 mm

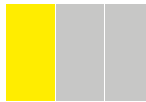

TCS



175 x 350 x 45 mm, 8 pieces

Code	Δ g
96 83 81 92	1300
No 20	sizes 6 x 7; 8 x 9; 10 x 11; 12 x 13; 14 x 15; 16 x 17; 18 x 21; 19 x 22 mm

TCS 20/8, 6x7-19x22 mm MF

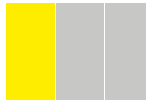

TCS



175 x 350 x 45 mm, 8 pieces

Code	Δ g
96 83 03 56	1323
No 20	sizes 6 x 7; 8 x 9; 10 x 11; 12 x 13; 14 x 15; 16 x 17; 18 x 21; 19 x 22 mm

TCS 20/10, 6x7-30x32 mm



TCS



350 x 350 x 45 mm, 10 pieces

Code	Δ g
96 83 01 66	2450
No 20	sizes 6 x 7; 8 x 9; 10 x 11; 12 x 13; 14 x 15; 16 x 17; 18 x 21; 19 x 22; 24 x 27; 30 x 32 mm

Made in Germany

23 Double ended ring spanners



shallow offset, DIN 897/ISO 10104 (metric sizes),
Chrome Alloy Steel, chrome plated.

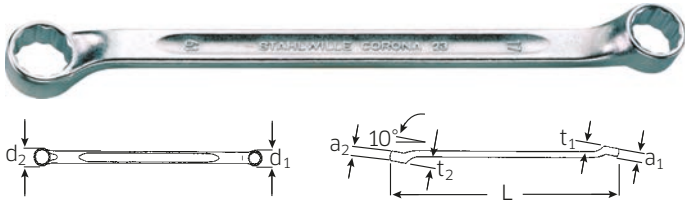

Code	Size mm	L mm	d ₁ mm	d ₂ mm	a ₁ mm	a ₂ mm	t ₁ mm	t ₂ mm	Weight g	Box
41070607	6 x 7	170	9.5	10.8	6	7	7	8	41	10
41070809	8 x 9	179	12.1	13.3	7	8	8	9	49	10
41071011	10 x 11	188	14.6	15.9	8.5	9.5	9	10	66	10
41071213	12 x 13	203	17.3	18.6	9.5	10.5	10	11	78	10
41071415	14 x 15	219	20.1	21.4	10.5	11.5	11	13	109	10
41071617	16 x 17	248	22.7	24.1	11.5	12.5	14	15	144	10
41071719	17 x 19	250	24.1	27	12.5	13.5	15	18	162	10
41071819	18 x 19	251	25.5	27	12.5	13.5	16	18	157	10
41072022	20 x 22	280	28.5	31.3	13.5	14.5	19	20	223	5
41072123	21 x 23	328	29.8	32.9	13.5	14.5	19	22	281	5
41072427	24 x 27	376	34.3	38.6	14.5	16	22	24	426	5
41073032	30 x 32	429	42.6	45.2	18	18	26	27	608	5

23/8 Set: Double ended ring spanners; 6x7-20x22 mm

shallow offset.



Code	Content mm	Weight g
96410704	6 x 7; 8 x 9; 10 x 11; 12 x 13; 14 x 15; 16 x 17; 18 x 19; 20 x 22	870

packed in carton



One like the other:
precisely and flaking
chrome-plated
over nickel.

180a Double ended ring spanners



short, shallow offset, Fed. Spec. GGG-W-636 E,
S.B.A.C. Techn. Spec. T.S. 48 up to size 1/2",
HPQ® high performance steel, chrome plated.

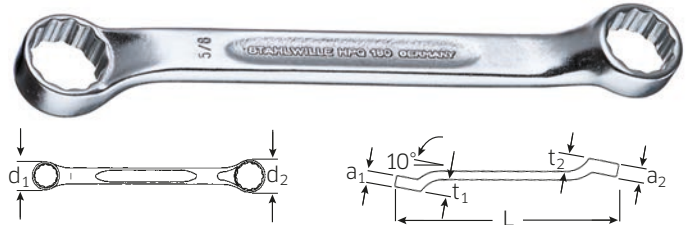

Code	Size "	L mm	d ₁ mm	d ₂ mm	a ₁ mm	a ₂ mm	t ₁ mm	t ₂ mm	Weight g	Box
41601620	1/4 x 5/16	107	10.2	11.8	7	8	7.2	7.4	26	10
41602428	3/8 x 7/16	122	14.6	16.7	6.7	7.8	9	10	42	10
41603234	1/2 x 9/16	141	18.5	20.7	8.7	9.5	11	12	62	10
41603436	5/16 x 3/8	148	20.7	22.6	9.5	10.5	11.5	12.5	87	10

230a Double ended ring spanners



shallow offset, SAE AS 954 (dimensions and test loads);
Fed. Spec. GGG-W-636E, S.B.A.C. Techn. Spec. T.S. 48 up to size 1/2",
HPQ® high performance steel, chrome plated.

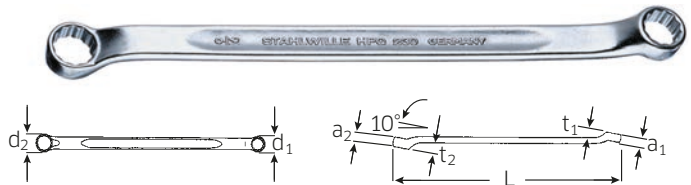

Code	Size "	L mm	d ₁ mm	d ₂ mm	a ₁ mm	a ₂ mm	t ₁ mm	t ₂ mm	Weight g	Box
41611620	1/4 x 5/16	180	10.2	11.9	5.2	6	7.9	8.8	45	10
41612022	5/16 x 11/32	195	11.9	13.5	7	8	8	9	45	10
41612024	5/16 x 3/8	195	11.9	14.6	6	7.9	10.8	12.4	54	10
41612428	3/8 x 7/16	215	14.6	16.7	7.9	8.7	11.4	11.7	74	10
41612832	7/16 x 1/2	225	16.7	19.5	8.7	9.1	11.9	12.6	105	10
41613234	1/2 x 9/16	235	19.5	20.7	9.1	9.5	12.2	12.9	119	10
41613436	9/16 x 5/8	245	20.7	22.6	9.5	11.5	13.8	13.9	122	10
41613640	5/8 x 3/4	274	22.6	27.5	11.1	12	14.8	15.8	156	10
41613840	11/16 x 3/4	275	25.4	27.5	11.1	12	15.2	15.8	158	10
41614244	13/16 x 7/8	301	29.5	31.7	13.5	14.5	19	20	175	5
41614648	15/16 x 1	340	34.1	36.5	14.5	15	22	23	375	5
41614850	1 x 1 1/16	368	36.5	38.6	15	16	23	24	460	5
41615256	1 1/8 x 1 1/4	403	40.8	45	16	18	25	27	620	5

220 Double ended ring spanners



extra long, 15° angled, SAE AS 954-E (test loads) (American sizes), HPQ® high performance steel, chrome plated.

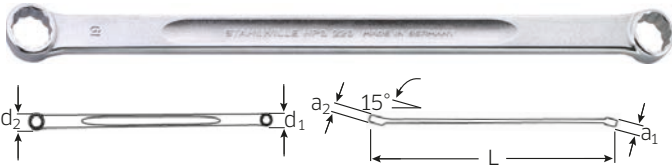

Code	Size mm	L mm	d ₁ mm	d ₂ mm	a ₁ mm	a ₂ mm	Δg g	
41035507	5.5 x 7	185	8.8	11	5.3	5.8	28	5
41030608	6 x 8	205	9.8	12.1	5.6	6	34	5
41030911	9 x 11	250	14.2	16.7	8	8.7	80	5
41031011	10 x 11	250	15.5	16.7	8	8.7	80	5
41031214	12 x 14	290	18.3	20.7	9.5	9.5	162	5
41031314	13 x 14	290	18.7	20.7	9.5	9.5	160	5
41031719	17 x 19	365	25	27.5	11	12	296	5
41031819	18 x 19	365	25.5	27.5	11	12	295	5
41031922	19 x 22	408	27.5	31.5	13	14.3	520	5
41032022	20 x 22	409	28.5	31.5	13	14.3	515	5

220a Double ended ring spanners

Code	Size "	L mm	d ₁ mm	d ₂ mm	a ₁ mm	a ₂ mm	Δg g	
41431416	7/32 x 1/4	184	9	9.9	5.3	5.8	29	5
41431620	1/4 x 5/16	205	9.9	12.2	5.6	6	33	5
41432428	3/8 x 7/16	250	14	16	8	8.7	79	5
41433234	1/2 x 9/16	290	18.5	21	9.5	9.5	160	5
41433640	5/8 x 3/4	363	22.6	27	11	12	298	5
41433840	11/16 x 3/4	365	25	27	11	12	291	5

220aSP Double ended ring spanners



extra long, with spline-drive profile, 15° angled, MS-33787, MIL-W-8982, HPQ® high performance steel, chrome plated.

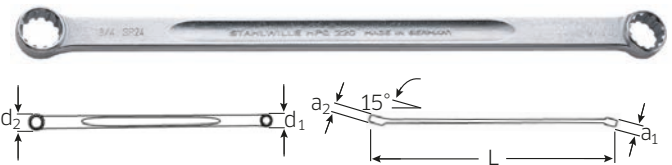

Code	Spline size	Size "	L mm	d ₁ mm	d ₂ mm	a ₁ mm	a ₂ mm	Δg g	
41160709	7x9	7/32 x 9/32	185	9.4	11.5	5.3	5.8	28	5
41160810	8x10	1/4 x 5/16	205	10.4	12.4	5.6	6	33	5
41161214	12x14	3/8 x 7/16	250	14.9	17	8	8.7	79	5
41161618	16x18	1/2 x 9/16	290	19	21	9.5	9.5	161	5
41161820	18x20	9/16 x 5/8	315	21	23	10	11	205	5
41162224	22x24	11/16 x 3/4	365	25	27.5	11	12	310	5
41162630	26x30	13/16 x 15/16	410	29.5	34	13	14.3	496	5
41162832	28x32	7/8 x 1	430	32	36.5	13.5	15	582	5

21 Double ended ring spanners



StahlwilleSTABIL®

straight, DIN 837/ISO 10103, Chrome Alloy Steel, chrome plated

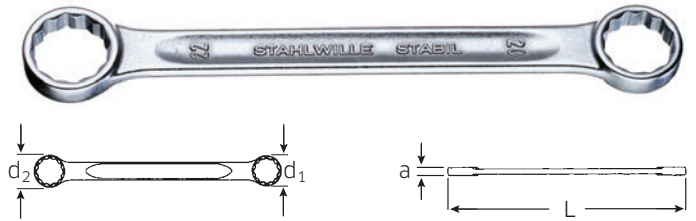

Code	Size mm	L mm	d ₁ mm	d ₂ mm	a mm	Δg g	
41050607	6 x 7	100	9.6	11	4.5	14	10
41050809	8 x 9	115	12.5	14	5.5	19	10
41050810	8 x 10	115	12.5	15.4	6	18	10
41051011	10 x 11	130	15.4	16.6	6	28	10
41051213	12 x 13	150	18.2	19.5	6.5	42	10
41051317	13 x 17	170	19.5	25	8	57	10
41051415	14 x 15	165	21	22.5	7.5	55	10
41051617	16 x 17	170	23.8	25	8	68	10
41051719	17 x 19	185	25	27.6	8	78	10
41051819	18 x 19	185	26.3	27.6	9	84	10
41051821	18 x 21	210	26.3	30.5	9	107	5
41051922	19 x 22	210	27.6	32.4	9	109	5
41052022	20 x 22	210	29	32.4	9	109	5
41052124	21 x 24	235	30.5	34.7	10	128	5
41052427	24 x 27	290	34.7	38.5	11	225	5
41052732	27 x 32	320	38.5	45.5	12	283	5
41053032	30 x 32	325	43	45.5	12	289	5
41053034	30 x 34	325	43	48.5	12	307	5

21 Sets: Double ended ring spanners

StahlwilleSTABIL®



Code	No	Content mm	Δg g
96410503	21/7	8 x 9; 10 x 11; 12 x 13; 14 x 15; 16 x 17; 18 x 19; 20 x 22	397
96410501	21/10	6 x 7; 8 x 9; 10 x 11; 12 x 13; 14 x 15; 16 x 17; 18 x 19; 20 x 22; 24 x 27; 30 x 32	943

packed in carton

21TX Double ended ring spanners

for external TORX® screws, straight, Chrome Alloy Steel, chrome plated.

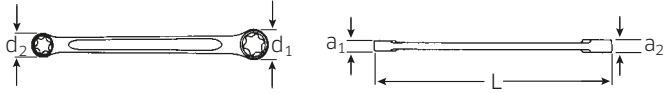

Code	size	L mm	d ₁ mm	d ₂ mm	a ₁ mm	a ₂ mm	△ g	
41 25 06 08	E6 x E8	115.5	9.6	11.6	4.5	5.5	17	10
41 25 10 12	E10 x E12	149.5	13.7	15.7	6.5	7.5	33	10
41 25 14 18	E14 x E18	185	17.8	22.5	8	9.5	71	10
41 25 20 24	E20 x E24	227	24.7	29.2	10.5	12.5	129	10

27 Double ended ring spanners STARTER



ISO 3318, Chrome Alloy Steel, chrome plated.

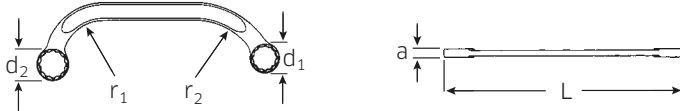

Code	size mm	L mm	d ₁ mm	d ₂ mm	a mm	r ₁ mm	r ₂ mm	△ g	
41 09 10 12	10 x 12	150	16.5	19.5	6.5	35	60	53	10
41 09 11 13	11 x 13	150	16.5	19.5	6.5	35	60	50	10
41 09 14 16	14 x 16	179	21	24.5	7.5	36	64	91	10
41 09 14 17	14 x 17	179	21	24.5	7.5	36	64	89	10
41 09 15 17	15 x 17	184	22.5	25	7.5	38	66	96	10
41 09 16 18	16 x 18	200	25.3	27.5	8.5	47	68	130	5
41 09 19 22	19 x 22	225	28	32	9	48	67	164	5

STAHLWILLE »AS-Drive«

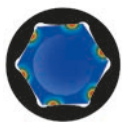

The rings of STAHLWILLE combination spanners and double ended ring spanners are equipped with the AS-Drive* profile: this permits high transmission of forces to the lands of nuts and bolts without damaging them. No longer will you have to worry about stripping the corners off nuts and bolts.

*Anti-Slip-Drive

24 Double ended open ring spanners, angled



hexagon, DIN 3118/ISO 3318 (metric sizes), Chrome Alloy Steel, chrome plated.

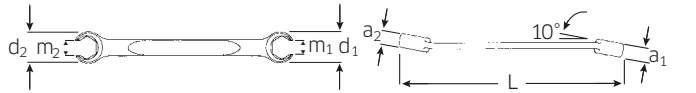

Code	size mm	L mm	d ₁ mm	d ₂ mm	a ₁ mm	a ₂ mm	m ₁ mm	m ₂ mm	△ g	
41 08 08 10	8 x 10	145	17.5	19.5	7	8.5	6.3	7.1	39	10
41 08 09 11	9 x 11	155	18.5	21.5	8.5	9	6.7	8.6	54	10
41 08 10 11	10 x 11	155	19.5	21.5	8.5	9	7.1	8.6	55	10
41 08 10 12	10 x 12	160	19.5	22.5	8.5	9.5	7.1	9	59	10
41 08 11 13	11 x 13	170	21.5	24	9	10	8.6	10	80	10
41 08 12 14	12 x 14	180	24	26	9.5	10.5	9	11	89	10

24a Double ended open ring spanners, angled

Code	size "	L mm	d ₁ mm	d ₂ mm	a ₁ mm	a ₂ mm	m ₁ mm	m ₂ mm	△ g	
41 48 16 20	1/4 x 5/16	105	16.5	18	5.5	7	3.7	5	32	10
41 48 20 24	5/16 x 3/8	145	17.5	19.5	7	8.5	6.3	7.1	39	10
41 48 24 28	3/8 x 7/16	155	19.5	21.5	8.5	9	7.1	8.6	57	10
41 48 32 34	1/2 x 9/16	180	24	26	9.5	10.5	9.5	11	87	10

24 Double ended open ring spanners, angled



bi-hexagon, DIN 3118/ISO 3318 (metric sizes), Chrome Alloy Steel, chrome plated.

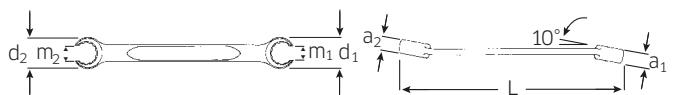

Code	size mm	L mm	d ₁ mm	d ₂ mm	a ₁ mm	a ₂ mm	m ₁ mm	m ₂ mm	△ g	
41 08 14 17	14 x 17	200	26	30	10.5	12	11	14	115	10
41 08 16 19	16 x 19*	220	29	33	12	13	13	15.8	155	5
41 08 17 19	17 x 19	220	30	33	12	13	14	15.8	151	10
41 08 19 22	19 x 22	230	33	37	13	15	15.8	17	192	5
41 08 22 24	22 x 24	245	37	40.5	15	16	17	18	251	5
41 08 24 27	24 x 27	270	40.5	44.5	16	17.5	18	20	310	5
41 08 27 36	27 x 36	300	42	54	16	19	20	27	414	5
41 08 30 32	30 x 32	300	48.5	50.5	20	22	22	24	455	5

* to be discontinued

24a Double ended open ring spanners, angled

Code	size "	L mm	d ₁ mm	d ₂ mm	a ₁ mm	a ₂ mm	m ₁ mm	m ₂ mm	△ g	
41 48 36 40	5/8 x 3/4	218	29	33	12	13	12.7	15.8	148	5
41 48 40 48	3/4 x 1	232	33	40.2	13	16	15.8	19	199	5

ES 24/7, 8x10-19x22 mm



175 x 350 x 30 mm, 7 pieces

Code	Content	Weight
96838171	No 24 sizes 8 x 10; 10 x 11; 11 x 13; 12 x 14; 14 x 17; 17 x 19; 19 x 22 mm	835 g
83812086	Empty tray	103 g

TCS 24/7, 8x10-19x22 mm

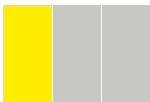

TCS



175 x 350 x 35 mm, 7 pieces

Code	Content	Weight
96838758	No 24 sizes 8 x 10; 10 x 11; 11 x 13; 12 x 14; 14 x 17; 17 x 19; 19 x 22 mm	780 g

240 Ratchet wrenches FastRatch

patent, specially suitable for union nuts. Using a single wrench, it is possible to tighten/loosen both metric and imperial nuts and bolts. Made of hardened and tempered stainless steel.

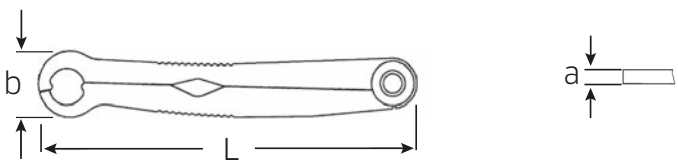

Code	Size	L	b	a	Weight	Box
41100808	8 5/16	121.4	16	4	60 g	1
41101010	10 3/8	133.3	20	4	70 g	1
41101111	11 7/16	140.4	23	5	103 g	1
41101212	12 15/32	146.3	25	5	100 g	1
41101313	13 1/2	168.4	26.8	6	154 g	1
41101414	14 9/16	174.6	29.6	6	180 g	1
41101616	16 5/8	191.3	32.8	7	270 g	1
41101717	17 21/32	201.7	34.3	7	292 g	1
41101818	18 11/16	212.8	36.2	7	310 g	1
41101919	19 3/4	238.5	38.5	7	367 g	1

240 Sets: Ratchet wrenches FastRatch

Roll-up wallet made of extremely tough textile with Velcro fastener.



Code	No	Content	Weight
96411003	240/4	8 mm - 5/16"; 10 mm - 3/8"; 11 mm - 7/16"; 14 mm - 9/16"	510 g
96411005	240/5	10 mm - 3/8"; 11 mm - 7/16"; 14 mm - 9/16"; 17 mm - 21/32"; 19 mm - 3/4"	1022 g
96411006	240/6	8 mm - 5/16"; 10 mm - 3/8"; 13 mm - 1/2"; 14 mm - 9/16"; 17 mm - 21/32"; 19 mm - 3/4"	1094 g

TCS 240/6

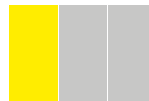

TCS



175 x 350 x 35 mm, 6 pieces

Code	Content	Weight
96838774	No 240 sizes 10; 11; 13; 14; 17; 19 mm	1163 g

17 Combination ratcheting spanners OPEN-RATCH

reversible, bi-hexagon, 72 teeth, for work in confined spaces, tight ratchet angle of only 5°, ring end offset by 15°, Chrome Alloy Steel, chrome plated.

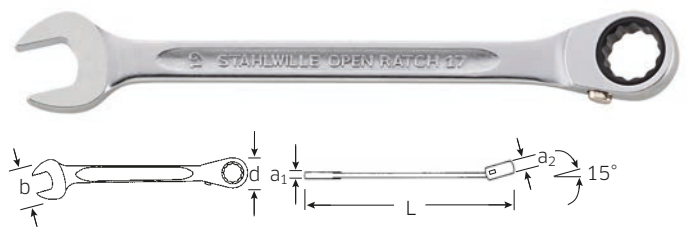

Code	Size	L	b	d	a1	a2	Weight	Box
41170808	8	144	17.0	18.0	4.7	7.4	38 g	5
41170909	9	150	18.8	19.5	5.3	7.4	49 g	5
41171010	10	158	21.7	21.0	5.7	8.4	67 g	5
41171111	11	165	23.0	22.0	6.1	8.4	68 g	5
41171212	12	173	25.2	23.5	6.4	8.4	84 g	5
41171313	13	182	26.5	25.0	6.6	8.4	89 g	5
41171414	14	190	29.5	26.5	7.3	8.4	110 g	5
41171515	15	202	31.3	28.0	7.5	8.4	128 g	5
41171616	16	215	33.4	29.0	7.7	10.0	153 g	5
41171717	17	229	36.3	30.5	7.9	10.0	177 g	5
41171818	18	240	38.0	32.0	8.4	11.5	198 g	5
41171919	19	252	39.0	34.0	8.7	11.5	224 g	5

17 Sets: Combination ratcheting spanners OPEN-RATCH, in roll-up wallet

Roll-up wallet made of extremely tough textile with Velcro fastener.



Code	No	Content mm	Δ g
96 41 17 05	17/5	8; 10; 13; 17; 19	732
96 41 17 12	17/12	8; 9; 10; 11; 12; 13; 14; 15; 16; 17; 18; 19	1665

TCS 17/12



175 x 350 x 45 mm, 12 pieces

Code	Δ g
96 83 06 49	1460

No 17 sizes 8; 9; 10; 11; 12; 13; 14; 15; 16; 17; 18; 19 mm

25 Ratchet ring spanners



with bi-hexagon, straight, 22 teeth, chrome plated.

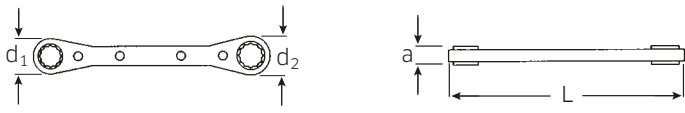

Code	mm	L mm	d ₁ mm	d ₂ mm	a mm	Δ g	
41 13 07 08	7 x 8	109	15	17	9	55	1
41 13 09 10	9 x 10	139	20	23	9	80	1
41 13 10 11	10 x 11	170	26	30	12	144	1
41 13 12 13	12 x 13	170	26	30	12	135	1
41 13 14 15	14 x 15	170	26	30	12	126	1
41 13 16 18	16 x 18	205	33	36	12	196	1
41 13 17 19	17 x 19	205	33	36	12	188	1

25aR Ratchet ring spanners

as No 25, but made of solid steel, Fed. Spec. GGG-W-001405.



Code	mm	L mm	d ₁ mm	d ₂ mm	a mm	Δ g	
41 56 16 20	1/4 x 5/16	109	15	17	9	65	1
41 56 20 22	5/16 x 11/32	109	15	17	9	60	1
41 56 24 28	3/8 x 7/16	139	20	23	9	90	1
41 56 32 34	1/2 x 9/16	174	26	30	12	164	1
41 56 36 38	5/8 x 11/16	205	33	36	12	257	1
41 56 40 44	3/4 x 7/8	235	36	40	13	296	1
41 56 42 46	13/16 x 15/16	235	36	40	12	281	1

25, 25a Sets: Ratchet ring spanners, in roll-up wallet

Roll-up wallet made of extremely tough textile with Velcro fastener.



Code	No	Content mm/"	Δ g
96 41 13 02	25/4	9 x 10; 12 x 13; 14 x 15; 17 x 19	556
96 41 13 01	25/7	7 x 8; 9 x 10; 10 x 11; 12 x 13; 14 x 15; 16 x 18; 17 x 19	1150
96 41 56 02	25a/4N	3/8 x 7/16; 1/2 x 9/16; 5/8 x 11/16; 3/4 x 7/8	1000
96 41 56 01	25a/7N	1/4 x 5/16; 5/16 x 11/32; 3/8 x 7/16; 1/2 x 9/16; 5/8 x 11/16; 3/4 x 7/8; 13/16 x 15/16	1271

ES 25/7, 7x8-17x19 mm



175 x 350 x 30 mm, 7 pieces

Code	Δ g
96 83 81 08	1040

No 25 sizes 7 x 8; 9 x 10; 10 x 11; 12 x 13; 14 x 15; 16 x 18; 17 x 19 mm

83 81 20 38	Empty tray	111
-------------	------------	-----

TCS 25/7



TCS



175 x 350 x 30 mm, 7 pieces

Code

Δ
g

96838751

984



No 25

sizes 7 x 8; 9 x 10; 10 x 11; 12 x 13;
14 x 15; 16 x 18; 17 x 19 mm

25aSP Spline drive ratchet ring spanners

straight, 22 teeth, chrome plated.



Code	Spline size	$\frac{O}{\text{mm}}$	L mm	d ₁ mm	d ₂ mm	a mm	Δ g	
41570810	8 x 10	1/4 x 5/16	109	15	17	9	59	1
41571214	12 x 14	3/8 x 7/16	139	20	23	9	84	1
41571618	16 x 18	1/2 x 9/16	174	26	30	12	153	1
41572022	20 x 22	5/8 x 11/16	205	33	36	12	250	1
41572428	24 x 28	3/4 x 7/8	235	36	40	13	279	1

25B Ratcheting bit holder

for hexagon BITS, magnetic location, reversible heads angled, chrome plated.

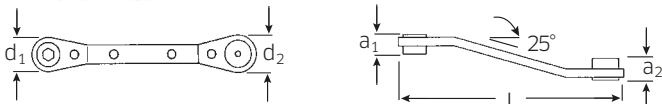

Code	inside $\frac{O}{\text{mm}}$	L mm	d ₁ mm	d ₂ mm	a ₁ mm	a ₂ mm	Δ g	
41541620	1/4 x 5/16	138	20	23	15	17	105	1

26a Ratchet ring spanners

AS DRIVE

reversible, with bi-hexagon, angled, 22 teeth, chrome plated.

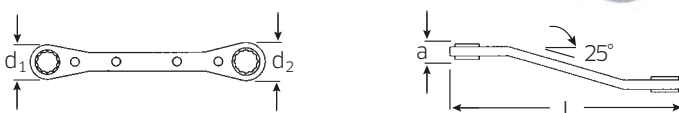

Code	$\frac{O}{\text{mm}}$	L mm	d ₁ mm	d ₂ mm	a mm	Δ g	
41551620	1/4 x 5/16	109	15	17	9	55	1
41552428	3/8 x 7/16	139	20	23	9	80	1
41553234	1/2 x 9/16	170	26	30	12	140	1

29

Double ended flexi-joint spanner FLEXI

AS DRIVE

hexagon, Chrome Alloy Steel, chrome plated.

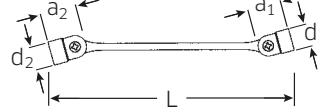

Code	$\frac{O}{\text{mm}}$	L mm	d ₁ mm	d ₂ mm	a ₁ mm	a ₂ mm	Δ g	
43010607	6 x 7	180	9.5	11	23	23	51	10

29

Double ended flexi-joint spanners FLEXI

AS DRIVE

bi-hexagon, Chrome Alloy Steel, chrome plated.

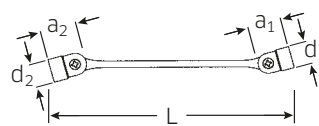

Code	$\frac{O}{\text{mm}}$	L mm	d ₁ mm	d ₂ mm	a ₁ mm	a ₂ mm	Δ g	
43010809	8 x 9	201	11.9	13.4	26	27.5	81	10
43011011	10 x 11	202	14.7	15.9	30.5	32	102	10
43011013	10 x 13	230.5	14.7	18.4	30	33.5	137	10
43011213	12 x 13	228	17.2	18.4	33	33.5	153	10
43011415	14 x 15	227	19.7	20.9	35	37	197	10
43011617	16 x 17	247	22.2	23.7	38.5	39	234	10
43011618	16 x 18	249	22.2	24.7	38.5	40	267	10
43011719	17 x 19	250	23.7	26.3	39	41	277	5
43011819	18 x 19	246.5	24.7	26.3	40	41	294	5
43012022	20 x 22	287.5	27.3	29.8	45.5	48	430	5
43012123	21 x 23	286.5	28.6	31.1	46.5	50	447	5
43012427	24 x 27	349.5	32.4	36.1	50.5	60.5	716	5

29a

Double ended flexi-joint spanners FLEXI

Code	$\frac{O}{\text{mm}}$	L mm	d ₁ mm	d ₂ mm	a ₁ mm	a ₂ mm	Δ g	
43412428	3/8 x 7/16	202	14	16	30.5	32	98	5
43413234	1/2 x 9/16	227	18.1	20	35	37	195	5
43413638	5/8 x 11/16	249.5	22.1	24	39	40	269	5

29/7

Set: Double ended flexi-joint spanners FLEXI; 8x9-20x22 mm



Code	Content mm	Δ g
96430101	8 x 9; 10 x 11; 12 x 13; 14 x 15; 16 x 17; 18 x 19; 20 x 22	1503

Standard packing: carton.

ES 29/6, 8x9-18x19 mm

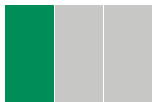

175 x 350 x 30 mm, 6 pieces

Code Δ g
96838109 1185

No 29 sizes 8 x 9; 10 x 11; 12 x 13; 14 x 15; 16 x 17; 18 x 19 mm

83812041 Empty tray 105

TCS 29/6, 8x9-18x19 mm



175 x 350 x 35 mm, 6 pieces

Code Δ g
96838764 1079

No 29 sizes 8 x 9; 10 x 11; 12 x 13; 14 x 15; 16 x 17; 18 x 19 mm

TCS 29/7, 8x9-20x22 mm



175 x 350 x 40 mm, 7 pieces

Code Δ g
96830195 1520

No 29 sizes 8 x 9; 10 x 11; 12 x 13; 14 x 15; 16 x 17; 18 x 19; 20 x 22 mm

Tool Control System

The safety inlay system

- Designed to fit our Tool Trolleys and Tool Boxes
- With yellow signal cut-outs to show whether all tools are in their places

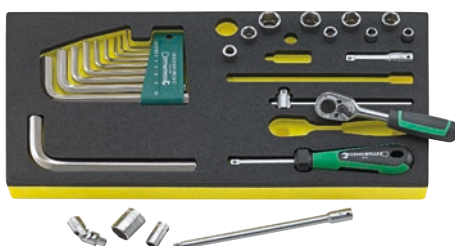

5 Heavy duty ring spanners

without tubular handle, Chrome Alloy Steel, chrome plated.

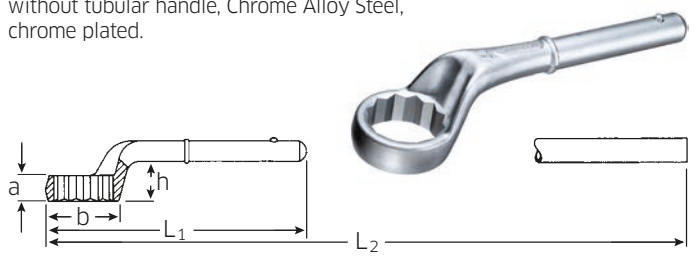

Code	\varnothing mm	L ₁ mm	L ₂ mm	b mm	a mm	h mm	Δ g	handle	
42020024	24	180	555	38	17	29.5	381	5 1/2 - 1	1
42020027	27	190	560	41	17	31.5	421	1	1
42020030	30	200	565	47	18	33.5	525	1	1
42020032	32	235	730	49	18	34	712	2	1
42020036	36	245	735	54	20	35.5	816	2	1
42020038	38	250	740	56	21	37.5	810	2	1
42020041	41	265	750	62	22	39.5	910	2	1
42020042	42	265	750	62	22	39.5	919	2	1
42020046	46	280	910	69	23	40	1192	3	1
42020050	50	290	920	76	25.5	42.5	1426	3	1
42020055	55	300	925	81	28	45.5	1541	3	1
42020060	60	345	1050	90	30.5	49	2260	4	1
42020065	65	355	1060	98	33	53	2603	4	1
42020070	70	365	1065	105	35.5	55	2882	4	1
42020075	75	375	1070	110	38	57.6	3058	4	1
42020080	80	385	1075	125	40.5	59	3889	4	1
42020085	85	385	1075	125	40.5	59	3648	4	1
42020090	90	410	1100	140	45	63	5238	4	1
42020095	95	410	1100	140	45	63	4630	4	1
42020100	100	412	1100	143	45	63	4895	4	1

No 5a available on request
 L₂ = length with handle No 5 1/2

5 1/2 Tubular handles

for heavy duty ring spanners No 5.



Code	size	L mm	d mm	\varnothing mm	\varnothing mm	Δ g	
48030001	1	460	19	24-30	1-1 3/16	605	1
48030002	2	610	22	32-42	1 1/4-1 11/16	1562	1
48030003	3	760	25	46-55	1 3/4-2 1/4	2820	1
48030004	4	860	30	60-100	2 3/8-3 7/8	3705	1



8 Striking face ring spanners

StahlwilleSTABIL®

Chrome Alloy Steel, green painted.

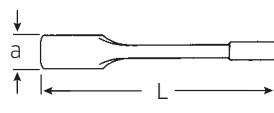
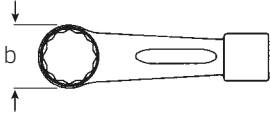

Code	Ø mm	L mm	b mm	a mm	ΔΔ g	
42010032	32	195	47	24	661	1
42010036	36	195	52.4	26	684	1
42010041	41	200	59	29	896	1
42010046	46	250	65	32	1218	1
42010050	50	280	70	35	1555	1
42010055	55	300	76	38	2087	1
42010060	60	300	82.5	42	2394	1
42010065	65	325	90.5	45	3209	1
42010070	70	355	97	48	3649	1
42010075	75	360	103.5	51	4428	1
42010080	80	440	110	57	5895	1
42010085	85	440	117	57	6033	1
42010090	90	445	124	60	6885	1
42010095	95	450	131	67	7875	1
42010100	100	455	137	72	10224	1
42010105	105	460	146	73	10202	1
42010110	110	500	156	82	14492	1
42010115	115	505	162	82	14376	1
42010120	120	510	174	82	15308	1

Additional spanner opening to DIN 7444 on request.



STAHLWILLE Striking face ring spanners
No 8 with bi-hexagon are stronger, thinner
and higher.

4205 Striking face ring spanners

DIN 7444, special steel, grey.



Code	Ø mm	L mm	b mm	a mm	ΔΔ g	
42050024	24	160	42.5	15	200	1
42050026	26	160	42.5	15	200	1
42050027	27	180	46	16	260	1
42050028	28	180	47	15.5	275	1
42050030	30	190	51.5	16.5	365	1
42050032	32	195	53	16.5	353	1
42050033	33	195	53	16.5	350	1
42050036	36	205	60	19.5	505	1
42050037	37	205	60	19.5	500	1
42050038	38	205	60	19.5	500	1
42050041	41	225	66	20.5	715	1
42050042	42	225	66	20.5	671	1
42050046	46	240	75	22.5	915	1
42050047	47	240	75	22.5	975	1
42050048	48	240	75	22.5	920	1
42050050	50	250	80	23.5	1120	1
42050052	52	250	80	23.5	1075	1
42050055	55	270	87.5	25	1375	1
42050056	56	270	87.5	25	1320	1
42050060	60	270	93.5	26	1565	1
42050064	64	290	101	29	2300	1
42050065	65	290	101	29	2100	1
42050070	70	320	109.5	33	3000	1
42050075	75	325	114.5	34	2780	1
42050080	80	345	126	35	4100	1
42050085	85	360	129	37	3835	1
42050090	90	400	152	41.5	5180	1
42050095	95	400	152	41.5	4900	1
42050100	100	400	152	41.5	6560	1
42050105	105	435	172	47.5	6300	1
42050110	110	435	172	47.5	7960	1
42050115	115	435	172	47.5	7495	1
42050120	120	480	182	54	9900	1
42050130	130	520	202	58	12640	1
42050135	135	520	202	58	12120	1
42050145	145	580	228	64	18250	1
42050160	160	580	228	64	18800	1
42050165	165	650	265	70	28500	1
42050170	170	650	265	70	27500	1
42050175	175	650	265	70	27500	1
42050180	180	650	265	70	26340	1
42050210	210	750	320	80	41000	1

Made in
Germany

4205a Striking face ring spanners

Code	mm	L mm	b mm	a mm	g	
42 45 00 56	1 1/4	190	52	17	350	1
42 45 00 58	1 5/16	190	52	17	350	1
42 45 00 64	1 1/2	205	58	18	500	1
42 45 00 66	1 5/8	230	66	20	700	1
42 45 00 67	1 11/16	230	66	20	700	1
42 45 00 69	1 13/16	240	74	22	975	1
42 45 00 70	1 7/8	240	74	22	975	1
42 45 00 72	2	255	80	24	1075	1
42 45 00 73	2 1/16	255	80	24	1075	1
42 45 00 75	2 3/16	270	86	25	1320	1
42 45 00 76	2 1/4	270	86	25	1340	1
42 45 00 78	2 3/8	280	93	26	1600	1
42 45 00 79	2 7/16	280	93	26	1600	1
42 45 00 81	2 9/16	300	102	30	2300	1
42 45 00 82	2 5/8	300	102	30	2300	1
42 45 00 84	2 3/4	330	110	33	2900	1
42 45 00 85	2 13/16	330	110	33	2900	1
42 45 00 87	2 15/16	330	110	33	2900	1

Additional spanner opening on request.

4204 Striking face open ended spanners

DIN 133, Special Tool Steel, grey finish.

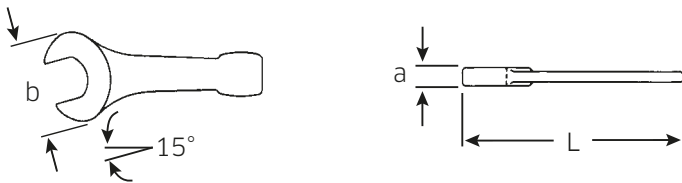

Code	mm	L mm	b mm	a mm	g	
42 04 00 27	27	180	56	16	321	1
42 04 00 30	30	190	62	17	451	1
42 04 00 32	32	190	62	17	424	1
42 04 00 36	36	215	76	17.5	698	1
42 04 00 41	41	235	86	18.5	923	1
42 04 00 46	46	255	98	20	1245	1
42 04 00 50	50	275	105	21	1445	1
42 04 00 55	55	300	116	23	2057	1
42 04 00 60	60	320	128	24.5	2559	1
42 04 00 65	65	342	138	27	3285	1
42 04 00 70	70	375	154	30	4573	1
42 04 00 75	75	375	154	30	4163	1
42 04 00 80	80	408	174	34	6059	1
42 04 00 85	85	408	174	34	5871	1
42 04 00 90	90	445	194	38	7600	1
42 04 00 95	95	445	194	38	7600	1
42 04 01 00	100	485	215	44	11500	1
42 04 01 05	105	485	215	44	11200	1

4004 Single-end spanners

DIN 894, Special Tool Steel, grey finish.

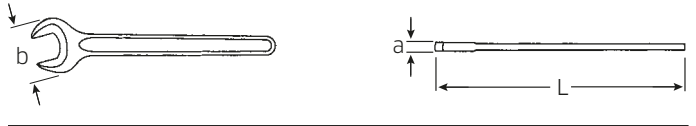

Code	mm	L mm	b mm	a mm	g	
40 04 02 40	24	215	50	8.9	147	1
40 04 02 70	27	238	56	9.8	193	1
40 04 03 00	30	261	62	10.8	268	1
40 04 03 20	32	273	66	11.8	315	1
40 04 03 60	36	300	74	12.8	421	1
40 04 04 10	41	335	83.5	12.8	555	1
40 04 04 60	46	369	93	14.8	770	1
40 04 05 00	50	412	102	17	1003	1
40 04 05 50	55	457	112	18	1267	1
40 04 06 00	60	492	122	18	1650	1
40 04 06 50	65	528	132	19	1900	1
40 04 07 00	70	572	142	20	2425	1
40 04 07 50	75	608	152	21	2758	1
40 04 08 00	80	645	162	22	2963	1
40 04 08 50	85	690	173	23	3717	1
40 04 09 00	90	690	173	23	3570	1
40 04 09 50	95	847	195	25	5943	1
40 04 10 00	100	847	195	25	5500	1
40 04 10 50	105	1000	217	28	8400	1
40 04 11 00	110	1000	217	28	9000	1
40 04 11 50	115	1000	225	28	8500	1
40 04 12 00	120	1000	225	28	8500	1
40 04 12 50	125	1000	225	28	7934	1
40 04 13 00	130	1000	225	28	8500	1
40 04 13 50	135	1000	225	28	8000	1

4025 Single-end spanners, adjustable

right-handed, DIN 3117/ISO 6787, B shape, jaw offset 22°, Chrome Vanadium, chrome plated.

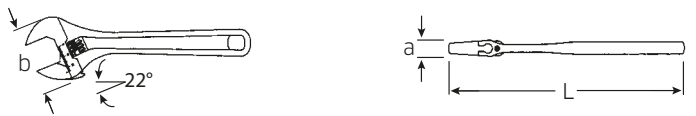

Code	size	max. mm	L mm	b mm	a mm	g	
40 25 00 04	4	13	114	33	9.5	53	5
40 25 00 06	6	20	159	48	12	123	5
40 25 00 08	8	24	206	60	13.5	241	5
40 25 00 10	10	29	257	71	16	410	5
40 25 00 12	12	34	309	83	19	708	5
40 25 00 15	15	43	384	103	25	1287	1
40 25 00 18	18	53	460	120	30	2105	1

4026 Single-end spanners, adjustable

left-handed, DIN 3117/ISO 6787, A shape, jaw offset 15°, Chrome-Vanadium, gunmetal finish.

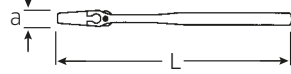
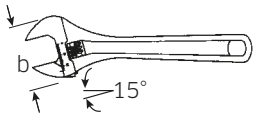

Code	size	max. mm	L mm	b mm	a mm	g	
40 26 00 04	4	13	114	33	9.5	50	5
40 26 00 06	6	20	159	48	12	138	5
40 26 00 08	8	24	206	60	13.5	247	5
40 26 00 10	10	29	257	71	16	397	5
40 26 00 12	12	34	309	83	19	699	5
40 26 00 15	15	43	384	103	25	1324	1
40 26 00 18	18	53	460	120	30	2076	1

TCS 4026/3

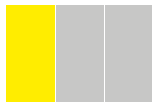

TCS



175 x 350 x 30 mm, 3 pieces

Code	g
96 83 87 65	1402



No 4026

sizes 8; 10; 12

10750 Box spanners

DIN 896 Type B, made of seamlessly drawn precision steel tubing, recessed at both ends, Chrome Alloy Steel, surface polished and chrome plated.

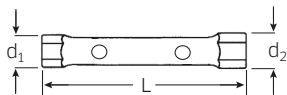

Code	mm	L mm	d ₁ mm	d ₂ mm	g	
43 33 06 07	6 x 7	110	10.5	11.5	26	10
43 33 08 09	8 x 9	110	13	14.5	38	10
43 33 10 11	10 x 11	125	16	17	50	10
43 33 12 13	12 x 13	145	19	20.5	78	10
43 33 14 15	14 x 15	145	21.5	22.5	78	10
43 33 16 17	16 x 17	155	24	26	127	10
43 33 17 19	17 x 19	160	26	28.5	199	10
43 33 18 19	18 x 19	160	27.5	28.5	199	10
43 33 20 22	20 x 22	170	29.5	32	232	5
43 33 21 23	21 x 23	170	30.5	33	251	5
43 33 24 26	24 x 26	190	34.5	37	300	5
43 33 24 27	24 x 27	190	34.5	38.5	301	5
43 33 30 32	30 x 32	205	42	45	382	5
43 33 32 36	32 x 36	225	45	50	535	2
43 33 36 41	36 x 41	225	50	56	648	2
43 33 41 46	41 x 46	245	56	62	755	2
43 33 46 50	46 x 50	245	62	68	878	2
43 33 55 60	55 x 60	245	70	76	1178	2

10750 Sets: Box spanners



Code	No	Content mm	g
96 43 12 02	10750/7	8 x 9; 10 x 11; 12 x 13; 14 x 15; 16 x 17; 18 x 19; 20 x 22	803
96 43 12 05	10750/11	6 x 7; 8 x 9; 10 x 11; 12 x 13; 14 x 15; 16 x 17; 18 x 19; 20 x 22; 21 x 23; 24 x 27; 30 x 32	1850

ES 10750/10, 6x7-20x22 mm



175 x 350 x 30 mm, 10 pieces

Code	g
96 83 81 68	1132
No 10750	sizes 6 x 7; 8 x 9; 10 x 11; 12 x 13; 14 x 15; 16 x 17; 18 x 19; 20 x 22 mm
No 10750 1/2	sizes 6; 7
83 81 20 84	Empty tray 103

TCS 10750/10, 6x7-20x22 mm

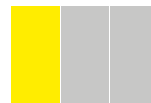

TCS



175 x 350 x 40 mm, 10 pieces

Code	g
96 83 87 56	1130
No 10750	sizes 6 x 7; 8 x 9; 10 x 11; 12 x 13; 14 x 15; 16 x 17; 18 x 19; 20 x 22 mm
No 10750 1/2	sizes 6; 7

10750 1/2 Tommy bars

for No 10750, stepped.



Code	size	for No 10750 mm	Length mm	g	
48 01 00 06	6	6 x 7-14 x 15	180	57	1
48 01 00 07	7	16 x 17-24 x 27	320	338	1
48 01 00 08	8	30 x 32-55 x 60	630	1400	1





3 | SOCKETS, SOCKET SETS

1/4"-DRIVE
→ PAGE 102



3/8"-DRIVE
→ PAGE 117



1/2"-DRIVE
→ PAGE 129



3/4"-DRIVE
→ PAGE 145



1"-DRIVE
→ PAGE 148



CROW-RING-, CROW-FOOT SPANNERS, ADAPTORS
→ PAGE 149



EMPTY BOXES AND TRAYS
→ PAGE 152





Provide guaranteed safety and efficiency. **STAHLWILLE sets of socket spanners and inserts**

The professionals in industry and the trades are under pressure to work quickly, accurately and economically. Which is why they make heavy demands on their tools. Due to the numerous technical innovations incorporated in them, STAHLWILLE ratchets and sockets make a valuable contribution to the prevention of both mistakes and injuries.

By using ratchets, adaptors and inserts made by STAHLWILLE, professional technicians are quite simply "making sure". It does not matter whether it is a full set of tools or individual components - users can be sure they will get top-of-the-range quality every time. This is guaranteed by adherence to the closest tolerances during production and stringently applied quality assurance measures in accordance with DIN EN ISO 9001. The legendary reliability and precision of these tools is enhanced by a large number of user-friendly features.

- Non-slip, ergonomically manufactured 2-component handles facilitate strain-free working.
- Slim-design sockets enable access to awkward places.
- The QuickRelease system ensures full control over the joint between the ratchet, the adaptors and the sockets.
- STAHLWILLE tool cases are particularly resilient thanks to the robust ABS plastic used. They are shaped for safe stacking and the integrated handles make transport easy. Convenient feature: on the inside of the cover is a list showing the contents of the case.
- Sculpted chemical-resistant cut-outs in special PE foam inlays prevent tools rattling and sliding around.



Light, robust, stackable: STAHLWILLE plastic cases. The inside of the cover shows the contents of the case.

**1**

Ergonomically designed 2-component handle made of impact-resistant, skydrol resistant plastic.

2

All metal parts are made of high-grade steel (Chrome Alloy Steel, chrome plated).

3

Firm seating and yet easy release of sockets and adaptors.

4

Wear parts can be easily replaced using sets of spares for sockets.

5

Ergonomic pawl to switch from clockwise to anti-clockwise.



Safety advantage 1

STAHLWILLE QuickRelease system

The problem: imagine what happens if a tool falls into an inaccessible place during repair or overhaul work.

The consequences: arduous, costly search and recovery, possibly involving disassembly of an aeroengine or machine.

The solution: the safety lock built into the QuickRelease system prevents damage to workpieces and guarantees secure, rapid connection of all individual components to form a single combined unit. Nothing can get lost because it is not possible to inadvertently release a tool. To release a tool, it is first necessary to press the release button deliberately. Even if you have oily or greasy hands, attaching and separating the individual components is so simple it noticeably smoothes your workflows.

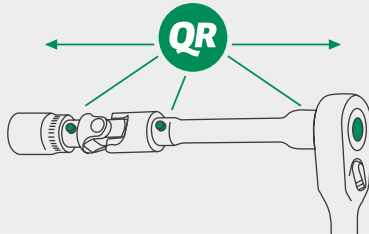

Safety advantage 2

STAHLWILLE AS-Drive

The problem: removing heavily corroded or thermally set fasteners requires the application of considerable force. The socket slips off the head of the fastener.

The consequences: uncontrolled movements cause injuries and damage to both the workpiece and the tools.

The solution: STAHLWILLE sockets are equipped with the AS-Drive* profile. This permits high transmission of forces to the lands of nuts and bolts without damaging them. The risk of injury is minimised and the corners of the fastener heads and nuts are no longer damaged.

*AS-Drive = Anti-Slip-Drive

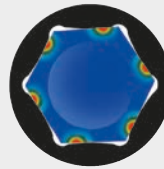

Safety advantage 3

STAHLWILLE HPQ®-inserts

The problem: although there is hardly enough room to move, you still have to apply considerable torque to loosen a stubborn threaded fasteners.

The consequences: many of the sockets available are useless simply because their wall thickness makes them impracticable in awkward places.

The solution: STAHLWILLE HPQ®-sockets are manufactured from selected tough steel alloys. These sockets will not slip off the head of the fastener, nor will they stretch when subjected to heavy loads. Their extremely thin walls and unbelievably high load capacity are simply exemplary. HPQ®-sockets are free of cadmium and are therefore suitable for use on titanium alloy parts and titanium fasteners as used e.g. in the aerospace industry, where safety is a crucial factor. They meet these aerospace standards: E DIN EN 3709, E DIN EN 3710, SAE AS 954-E, S.B.A.C. AS 40605/40606, MS-33787, MIL-W-8982.

* = High Performance Quality



Safety advantage 4

STAHLWILLE fine-tooth ratchets

STAHLWILLE offers a wide selection of efficient fine-tooth ratchets. Whether it is with the ergonomic 2-component handle or the slim-line steel version for working spaces where every centimetre counts.

80 teeth and perfectly balanced precision mechanics ensure excellent finger-tip control and loading capacity. The tight ratchet angle of only 4.5° enables efficient working anywhere. In addition, the screwless construction, compliant with FOD requirements, makes these models the preferred choice for use in safety relevant applications, such as aerospace.



1. 415QR N 1/4"
2. 435QR N 3/8"
3. 512QR N 1/2"

1. 415SG-QR N 1/4"
2. 435SG-QR N 3/8"
3. 512SG-QR N 1/2"

Sockets, Socket Sets

6.3
1/4"

DIN
3120

ISO
1174-1

3

40D

Sockets



metric sizes: DIN 3124/ISO 2725-1, E DIN EN 3709, ASME B 107.5M, American sizes: ASME B 107.1, Fed. Spec. GGG-W-641, SAE AS 954-E (test loads), HPQ® high performance steel, chrome plated.

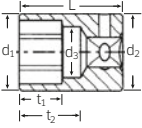

Code	Ø mm	d ₁ mm	d ₂ mm	d ₃ mm	L mm	t ₁ mm	t ₂ mm	△ g	
01030005	5	7.9	10.7	4	23	4.5	15	9	10
01030055	5.5	8.5	10.7	4.5	23	6	15	9	10
01030006	6	9.2	10.7	5	23	6	15	9	10
01030007	7	10.7	10.7	6	23	6.5	13.4	10	10
01030008	8	11.6	11.6	7	23	8	13.1	11	10
01030009	9	12.8	12.8	8	23	8	12.8	13	10
01030010	10	14.3	14.3	9	23	8	14.9	17	10
01030011	11	15.5	15.5	10	23	9	14.6	19	10
01030012	12	16.5	16.5	11	23	9.5	14.3	23	10
01030013	13	17.8	17.8	12	23	9.5	14	25	10
01030014	14	18.8	18.8	13	24	10	14.7	32	10

40aD

Sockets

Code	Ø "	d ₁ mm	d ₂ mm	d ₃ mm	L mm	t ₁ mm	t ₂ mm	△ g	
01530010	5/32	6.7	10.7	3.2	23	3.5	15	7	10
01530012	3/16	7.6	10.7	4	23	4.5	15	9	10
01530014	7/32	8.6	10.7	5	23	6	15	9	10
01530016	1/4	9.4	10.7	5.5	23	6	15	9	10
01530018	9/32	10.7	10.7	6.6	23	6.5	13.2	10	10
01530020	5/16	11.6	11.6	7	23	8	13.1	11	10
01530022	11/32	12.7	12.7	8.1	23	8	13.3	13	10
01530024	3/8	13.7	13.7	8.3	23	8	13.3	16	10
01530028	7/16	15.8	15.8	10	23	9	14.6	21	10
01530032	1/2	17.3	17.3	11.5	23	9.5	14.1	27	10
01530034	9/16	18.8	18.8	13.1	24	10	14.7	31	10

40aD/10CL

Set: Sockets with clip strip



Content:
3/16; 7/32; 1/4; 9/32; 5/16; 11/32; 3/8; 7/16; 1/2; 9/16"
1 clip strip No 40CL-2



Code	△ g
96015310	206

40

Sockets



metric sizes: DIN 3124/ISO 2725-1, ASME B 107.5M, E DIN EN 3709 (test loads), American sizes: ASME B 107.1, Fed. Spec. GGG-W-641, SAE AS 954-E (test loads), HPQ® high performance steel, chrome plated.

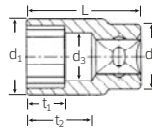

Code	Ø mm	d ₁ mm	d ₂ mm	d ₃ mm	L mm	t ₁ mm	t ₂ mm	△ g	
01010003	3	5.6	10.7	2.5	23	2	15	7	10
01010032	3.2	5.6	10.7	2.5	23	2	15	8	10
01010035	3.5	6	10.7	2.5	23	2.5	15	8	10
01010004	4	6.7	10.7	3.2	23	3.5	15	9	10
01010045	4.5	7.3	10.7	3.7	23	4	15	9	10
01010005	5	7.9	10.7	4	23	4.5	15	8	10
01010055	5.5	8.5	10.7	4.5	23	6	15	9	10
01010006	6	9.2	10.7	5	23	6	15	9	10
01010007	7	10.7	10.7	6	23	6.5	13.4	10	10
01010008	8	11.6	11.6	7	23	8	13.1	11	10
01010009	9	12.8	12.8	8	23	8	12.8	14	10
01010010	10	14.3	14.3	9	23	8	14.9	17	10
01010011	11	15.5	15.5	10	23	9	14.6	19	10
01010012	12	16.5	16.5	11	23	9.5	14.3	24	10
01010013	13	17.8	17.8	12	23	9.5	14	26	10
01010014	14	18.8	18.8	13	24	10	14.7	32	10

40a

Sockets

Code	Ø "	d ₁ mm	d ₂ mm	d ₃ mm	L mm	t ₁ mm	t ₂ mm	△ g	
01410008	1/8	5.6	10.7	2.5	23	2	15	7	10
01410010	5/32	6.7	10.7	3.2	23	3.5	15	9	10
01410012	3/16	7.6	10.7	4	23	4.5	15	9	10
01410014	7/32	8.6	10.7	5	23	6	15	9	10
01410016	1/4	9.4	10.7	5.5	23	6	15	9	10
01410018	9/32	10.7	10.7	6.6	23	6.5	13.2	10	10
01410020	5/16	11.6	11.6	7	23	8	13.1	12	10
01410022	11/32	12.7	12.7	8.1	23	8	13.3	14	10
01410024	3/8	13.7	13.7	8.3	23	8	13.3	16	10
01410028	7/16	15.8	15.8	10	23	9	14.6	21	10
01410032	1/2	17.3	17.3	11.5	23	9.5	14.1	27	10
01410034	9/16	18.8	18.8	13.1	24	10	14.7	31	10

STAHLWILLE »AS-Drive«

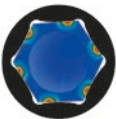

STAHLWILLE sockets are equipped with the AS-Drive® profile: this permits high transmission of forces to the lands of nuts and bolts without damaging them. No longer will you have to worry about stripping the corners off nuts and bolts.

*Anti-Slip-Drive

40DL Sockets



extra deep, metric sizes: E DIN EN 3710, E DIN EN 3709, DIN 3124/ISO 2725-1, ASME B 107.5M, American sizes: ASME B 107.1, Fed. Spec. GGG-W-641, SAE AS 954-E, HPQ® high performance steel, chrome plated.

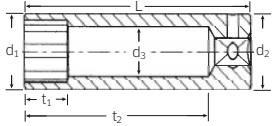

Code		d ₁ mm	d ₂ mm	d ₃ mm	L mm	t ₁ mm	t ₂ mm	$\Delta\Delta$ g	
01240005	5	7.9	10.7	4	50	4.5	42	15	5
01240055	5.5	8.5	10.7	4.5	50	6	42	16	5
01240006	6	9.2	10.7	5	50	6	42	18	5
01240007	7	10.7	10.7	6	50	6.5	40.9	21	5
01240008	8	11.6	11.6	7	50	8	40.1	23	5
01240009	9	12.8	12.8	8	50	8	39.8	30	5
01240010	10	14.3	14.3	9	50	9	41.9	35	5
01240011	11	15.5	15.5	10	50	10.5	41.6	40	5
01240012	12	16.5	16.5	11	50	12	41.3	47	5
01240013	13	17.8	17.8	12	50	12	41	50	5
01240014	14	18.8	18.8	13	50	15	40.7	57	5

40aDL Sockets

Code		d ₁ mm	d ₂ mm	d ₃ mm	L mm	t ₁ mm	t ₂ mm	$\Delta\Delta$ g	
01640010	5/32	6.7	10.7	3.2	50	4.5	42	13	5
01640012	3/16	7.6	10.7	4	50	4.5	42	15	5
01640014	7/32	8.6	10.7	5	50	6	42	16	5
01640016	1/4	9.4	10.7	5.2	50	6	42	19	5
01640018	9/32	10.7	10.7	6.5	50	8	40.2	20	5
01640020	5/16	11.6	11.6	7	50	8	40.1	24	5
01640022	11/32	12.7	12.7	8.1	50	9	39.7	26	5
01640024	3/8	13.7	13.7	8.3	50	9	39.7	33	5
01640028	7/16	15.8	15.8	10	50	10.5	41.6	42	5
01640032	1/2	17.3	17.3	11.5	50	12	41.1	44	5
01640034	9/16	18.8	18.8	13.1	50	15	40.7	55	5

STAHLWILLE HPQ® sockets



STAHLWILLE HPQ® sockets are manufactured from selected tough steel alloys. The result: they are extremely durable. HPQ® sockets are free of cadmium and are therefore suitable for use on titanium alloy parts and titanium fasteners as used e.g. in the aerospace industry, where safety is a crucial factor.

*High Performance Quality

40aDL/7 Set: Sockets



extra deep
Content: 3/16; 1/4; 5/16; 3/8; 7/16; 1/2; 9/16"



Code	$\Delta\Delta$ g
96016401	241

packed in carton

40aDL/10CL Set: Sockets with clip strip



Content: 3/16; 7/32; 1/4; 9/32; 5/16; 11/32; 3/8; 7/16; 1/2; 9/16"
1 clip strip No 40CL-2



Code	$\Delta\Delta$ g
96016410	350

40aDV Sockets



SAE AS 954, S.B.A.C. AS 40605/40606, HPQ® high performance steel, chrome plated.

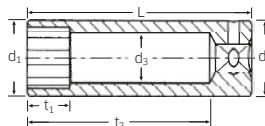

Code		d ₁ mm	d ₂ mm	d ₃ mm	L mm	t ₁ mm	t ₂ mm	$\Delta\Delta$ g	
01650014	7/32	8.6	10.7	5	31.8	6	23.8	12	10
01650016	1/4	9.4	10.7	5.2	31.8	6	23.8	13	10
01650018	9/32	10.7	10.7	6.6	31.8	6.5	22	13	10
01650020	5/16	11.6	11.6	7	31.8	8	21.9	15	10

6.3
1/4"

DIN
3120

ISO
1174-1

3

Sockets, Socket Sets

6.3
1/4"

DIN
3120

ISO
1174-1

3

40L Sockets



extra deep, DIN 3124/ISO 2725-1, ASME B 107.5M, E DIN EN 3710, E DIN EN 3709 (test loads), HPQ® high performance steel, chrome plated.

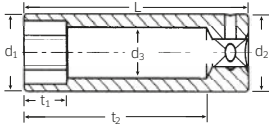

Code	mm	d ₁ mm	d ₂ mm	d ₃ mm	L mm	t ₁ mm	t ₂ mm	Δg	g	
01020032 NEW	3.2	5.6	10.7	2.5	50	2	37.5	11.5	10	
01020004	4	6.7	10.7	3.2	50	3.5	42	14	10	
01020045	4.5	7.3	10.7	3.7	50	4	42	15	10	
01020005	5	7.9	10.7	4	50	4.5	42	16	10	
01020055	5.5	8.5	10.7	4.5	50	6	42	17	10	
01020006	6	9.2	10.7	5	50	6	42	18	10	
01020007	7	10.7	10.7	6	50	6.5	40.9	24	10	
01020008	8	11.6	11.6	7	50	8	40.1	27	10	
01020009	9	12.8	12.8	8	50	8	39.8	31	10	
01020010	10	14.3	14.3	9	50	9	41.9	38	10	
01020011	11	15.5	15.5	10	50	10.5	41.6	43	10	
01020012	12	16.5	16.5	11	50	12	41.3	49	10	
01020013	13	17.8	17.8	12	50	12	41	56	10	

402 UNIFLEX sockets



American sizes: SAE AS 954, ASME B 107.1, HPQ® high performance steel, chrome plated.

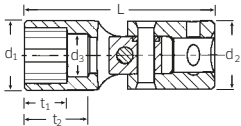

Code	mm	d ₁ mm	d ₂ mm	d ₃ mm	L mm	t ₁ mm	t ₂ mm	Δg	g	
01140006	6	9.2	12.7	5	32	5.5	10	16	5	
01140007	7	10.4	12.7	6	33.5	6	11.5	16	5	
01140008	8	11.6	12.7	6.7	35	8	13	17	5	
01140009	9	13	12.7	8	36	8	12	20	5	
01140010	10	14.2	12.7	9	38	12	14	21	5	

402a UNIFLEX sockets

Code	mm	d ₁ mm	d ₂ mm	d ₃ mm	L mm	t ₁ mm	t ₂ mm	Δg	g	
01540014	7/32	8.6	12.7	4.8	32	5.5	10	17	5	
01540016	1/4	9.6	12.7	5.2	32	5.5	10	16	5	
01540018	9/32	11	12.7	6.4	32	6.5	10	19	5	
01540020	5/16	11.6	12.7	6.7	35	8	13	17	5	
01540022	11/32	12.7	12.7	8	35	7.5	11.5	19	5	
01540024	3/8	13.6	12.7	9	38	8.6	13.1	20	5	
01540028	7/16	15.7	12.7	10.5	39.5	10.7	15	23	5	
01540032	1/2	17.3	12.7	12	41.5	11.1	16.5	27	5	

402a/5 Set: UNIFLEX sockets



Content: 1/4; 5/16; 3/8; 7/16; 1/2"



Code	Δg	g
96015401		101

402aK UNIFLEX sockets



short version, HPQ® high performance steel, chrome plated.

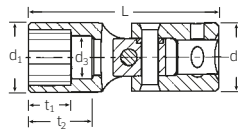

Code	"	d ₁ mm	d ₂ mm	d ₃ mm	L mm	t ₁ mm	t ₂ mm	Δg	g	
01541024	3/8	13.6	12.7	6.7	34	9.1	12.0	19	5	
01541034	9/16	19	12.7	13.1	37.5	10.3	11.8	25	5	

40TX Sockets



for external TORX® screws, HPQ® high performance steel, chrome plated.

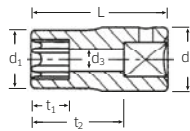

Code	size	mm	d ₁ mm	d ₂ mm	d ₃ mm	L mm	t ₁ mm	t ₂ mm	Δg	g	
01270004	E4	3.8	5.6	10.7	2	23	4.5	15	8	10	
01270005	E5	4.7	6.7	10.7	2.8	23	5	15	7	10	
01270006	E6	5.7	8	10.7	3.6	23	5.5	15	10	10	
01270007	E7	6.2	9.6	10.7	3.8	23	6.5	15	10	10	
01270008	E8	7.5	10.5	11.6	4.3	23	7	15	10	10	
01270010	E10	9.4	12.7	12.7	5.6	23	9	15	17	10	

40aSP Sockets spline-drive

HPQ

MS-33787, MIL-W-8982, HPQ® high performance steel, chrome plated.



Code	Spline size	"	d ₁ mm	d ₂ mm	d ₃ mm	L mm	t ₁ mm	t ₂ mm	g	
01011007	7	7/32	8.6	10.7	5	22.2	6	14.2	7	1
01011008	8	1/4	9.5	10.7	5.6	22.2	7	14.2	10	1
01011009	9	9/32	11.2	11.2	6.6	22.2	8	12.4	10	1
01011010	10	5/16	11.6	11.6	7.1	22.2	8	12.2	12	1
01011012	12	3/8	13.8	13.8	8.6	23	8.7	12.6	18	1
01011014	14	7/16	15.7	15.7	10.4	25	10.7	14.1	24	1

40aLSP Sockets spline-drive

HPQ

extra deep bolt clearance, MS-33787, MIL-W-8982, HPQ® high performance steel, chrome plated.

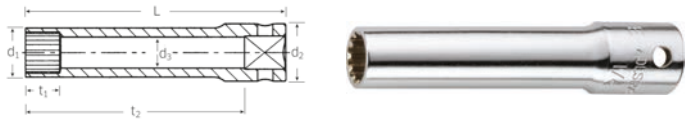

Code	Spline size	"	d ₁ mm	d ₂ mm	d ₃ mm	L mm	t ₁ mm	t ₂ mm	g	
01021007	7	7/32	8.6	10.7	5	50.8	6	42.8	18	1
01021008	8	1/4	9.5	10.7	5.6	50.8	8	42.8	24	1
01021010	10	5/16	11.6	11.6	7.1	50.8	8	40.8	27	1

402aSP UNIFLEX sockets spline-drive

HPQ

MS-33787, MIL-W-8982, HPQ® high performance steel, chrome plated.



Code	Spline size	"	d ₁ mm	d ₂ mm	d ₃ mm	L mm	t ₁ mm	t ₂ mm	g	
01542016	8	1/4	9.5	12.7	5.6	32	6.4	9.8	16	5
01542020	10	5/16	11.6	12.7	7.1	35	8	13	18	5

41K Screwdriver sockets

for slotted screws, blades to DIN 5264, Chrome Alloy Steel, chrome plated.



Code	"	L ₁ mm	L ₂ mm	d mm	a mm	b mm	g	
01280006	0.6x3.5	28	16	11.6	0.6	3.5	9	5
01280008	0.8x4	28	16	11.6	0.8	4	10	5
01280010	1x5.5	28	16	11.6	1	5.5	11	5
01280012	1.2x8	28	16	11.6	1.2	8	12	5

44 INHEx sockets

for socket head screws, DIN 7422, Chrome Alloy Steel, chrome plated.

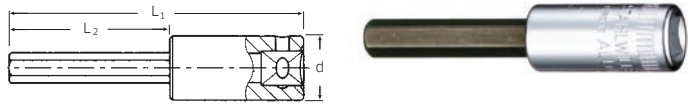

Code	"	L ₁ mm	L ₂ mm	d mm	g	
01050003	3	55	30	10.7	14	5
01050004	4	55	30	10.7	16	5
01050005	5	55	30	10.7	20	5
01050006	6	55	30	11.6	26	5

44a INHEx sockets

Code	"	L ₁ mm	L ₂ mm	d mm	g	
01450004	1/16	55	30	10.7	11	5
01450005	5/64	55	30	10.7	12	5
01450006	3/32	55	30	10.7	14	5
01450007	7/64	55	30	10.7	17	5
01450008	1/8	55	30	10.7	12	5
01450009	9/64	55	30	10.7	13	5
01450010	5/32	55	30	10.7	14	5
01450012	3/16	55	30	10.7	17	5
01450014	7/32	55	30	10.7	19	5
01450016	1/4	55	30	11.6	24	5

44K INHEx sockets

for socket head screws, Chrome Alloy Steel, chrome plated.



Code	"	L ₁ mm	L ₂ mm	d mm	g	
01120003	3	28	16	11.6	10	5
01120004	4	28	16	11.6	10	5
01120005	5	28	16	11.6	10	5
01120006	6	28	16	11.6	10	5
01120008	8	28	16	11.6	15	5

6.3
1/4"

DIN
3120

ISO
1174-1

3

Sockets, Socket Sets

6.3
1/4"

DIN
3120

ISO
1174-1

3

44KTX Screwdriver sockets

for inside TORX® screws, Chrome Alloy Steel, chrome plated.

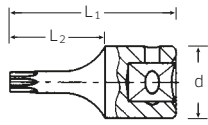

Code	size	mm	L ₁ mm	L ₂ mm	d mm	△△ g	
01 35 00 08	T8	2.3	28	16	11.6	10	5
01 35 00 09	T9	2.5	28	16	11.6	10	5
01 35 00 10	T10	2.7	28	16	11.6	10	5
01 35 00 15	T15	3.3	28	16	11.6	10	5
01 35 00 20	T20	3.8	28	16	11.6	11	5
01 35 00 25	T25	4.4	28	16	11.6	11	5
01 35 00 27	T27	5.0	28	16	11.6	11	5
01 35 00 30	T30	5.5	28	16	11.6	11	5
01 35 00 40	T40	6.6	28	16	11.6	12	5

44KTXB Screwdriver sockets

with hollow point, for inside TORX® screws (TORX® TAMPER RESISTANT), Chrome Alloy Steel, chrome plated.

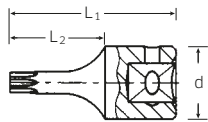

Code	size	mm	L ₁ mm	L ₂ mm	d mm	△△ g	
01 35 10 08	T8	2.3	28	16	11.6	10	5
01 35 10 09	T9	2.5	28	16	11.6	10	5
01 35 10 10	T10	2.7	28	16	11.6	10	5
01 35 10 15	T15	3.3	28	16	11.6	10	5
01 35 10 20	T20	3.8	28	16	11.6	10	5
01 35 10 25	T25	4.4	28	16	11.6	11	5
01 35 10 27	T27	5.0	28	16	11.6	10	5
01 35 10 30	T30	5.5	28	16	11.6	11	5
01 35 10 40	T40	6.6	28	16	11.6	12	5

44P Screwdriver sockets

for recessed head screws Phillips-Recess®, tips to DIN 5260, Chrome Alloy Steel, chrome plated.

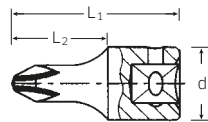

Code	PH size	L ₁ mm	L ₂ mm	d mm	△△ g	
01 29 00 01	1	28	16	11.6	12	5
01 29 00 02	2	28	16	11.6	11	5
01 29 00 03	3	28	16	11.6	12	5
01 29 00 04	4	28	16	11.6	14	5

44PZ Screwdriver sockets

for POZIDRIV/SUPADRIV® screws, Chrome Alloy Steel, chrome plated.

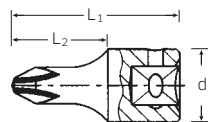

Code	PZ size	L ₁ mm	L ₂ mm	d mm	△△ g	
01 30 00 01	1	28	16	11.6	10	5
01 30 00 02	2	28	16	11.6	11	5

40CL Clip strips

for socket retention, with 9 or 10 retaining clips. Supplied without sockets.



Code	size	L mm	△△ g	
80 40 00 01	1	200	36	5
80 40 00 02	2	300	52	5

Drive tools and accessories

1/4" □, finish: Chrome Alloy Steel, chrome plated.

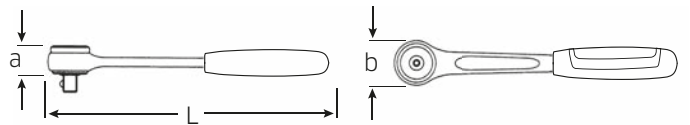

411 Ratchet, fine tooth

reversible, 60 teeth, with 2-component handle, for use in confined spaces, re-engages after movement of 6°, DIN 3122/ISO 3315.



Code	L mm	b mm	a mm	△△ g	
11 23 10 11	118	24	19.5	96	1

415 Ratchet

reversible, 22 teeth, with 2-component handle, DIN 3122/ISO 3315.



Code	L mm	b mm	a mm	△△ g	
11 11 10 10	117	22	13	80	5

415QR QuickRelease ratchet

QR

reversible, 22 teeth, with QuickRelease safety lock and 2-component handle, DIN 3122/ISO 3315, registered design.



Code	L mm	b mm	a mm	△△ g	
11 11 00 20	117	22	13	79	1

415QR N QuickRelease ratchet, fine tooth

QR F2D

reversible, 80 teeth, with QuickRelease safety lock and 2-component handle, for use in confined spaces, re-engages after movement of 4.5°, construction without screws prevents foreign object damage, DIN 3122/ISO 3315, registered design.



Code	L mm	b mm	a mm	△△ g	
11 11 10 20	117	22.6	10.7	79	1

415SG-QR N QuickRelease ratchet, fine tooth NEW



reversible, 80 teeth, with QuickRelease safety lock and steel handle, for use in confined spaces, re-engages after movement of 4.5°, construction without screws prevents foreign object damage, DIN 3122/ISO 3315, registered design

Code	L mm	b mm	a mm	 g	
11 11 1030	117	22.6	10.7	90	1

415QRL N QuickRelease ratchet, fine tooth NEW



long, reversible, 80 teeth, with QuickRelease safety lock and 2-component handle, for use in confined spaces, re-engages after movement of 4.5°, construction without screws prevents foreign object damage, DIN 3122/ISO 3315, registered design.

Code	L mm	b mm	a mm	 g	
11 11 1040	153	22.6	10.7	96	1

415B Bit ratchet

reversible, 22 teeth, with 2-component handle and inside hexagon, 1/4", DIN 3126/ISO 1173 D 6.3 for BITS Screwdriver sockets 1/4".



Internal hex drive with a collar-thrust spring. Bits are easy to insert, lock securely in position and can be removed just as easily; even hex bits with a wide groove (Type E, DIN 3126/ISO 1173).

Code	L mm	b mm	a mm	 g	
11 13 1011	117	22	12	76	5

415SGB N Bit ratchet, fine tooth NEW



reversible, 80 teeth, with steel handle and inside hexagon, 1/4", DIN 3126/ISO 1173 D 6.3 for Bits Screwdriver sockets 1/4". Internal hex drive with a collar-thrust spring. Bits are easy to insert, lock securely in position and can be removed just as easily; even hex bits with a wide groove (Type E, DIN 3126/ISO 1173), for use in confined spaces, re-engages after movement of 4.5°, construction without screws prevents foreign object damage.

Code	L mm	b mm	a mm	 g	
11 13 2020	117	22.6	10.7	85	1

416QR QuickRelease fine-tooth flexible-joint ratchet NEW



reversible, 80 teeth, with QuickRelease safety lock and 2-component handle, handle may be raised or lowered by approx. 90°. Lockable in following positions: straight, 30° up, 60° up, 30° down. Release the lock by pressing the button in the handle, for use in confined spaces, re-engages after movement of 4.5°, construction without screws prevents foreign object damage, DIN 3122/ISO3315, registered design.

Code	L mm	b mm	a mm	 g	
11 26 1010	170	22.5	12	170	1

415QR N/7 Set of wrenches NEW



in sturdy, stackable ABS plastic case, 7 pieces

Content :

- 1 ratchet No 415QR N
- 3 extension No 405QR/2 (54 mm), No 405QR/4 (102 mm), No 405QR/6 (150 mm)
- 1 universal joint No 407QR
- 1 drive handle No 400QR
- 1 T-handle No 404QR

Code	 g	
96 01 40 10	758	1

4110 Spare parts set for ratchets No 411, 416

Content:

- 1 pinion; 1 pawl; 1 switching disk; 1 spring; 3 screws

Code	 g	
19 20 00 01	47	1

4150 Spare parts set for ratchets No 415, 415SK, 415SG

Content:

- 1 pinion; 1 pawl; 1 lever with pin; 1 ball; 2 compression springs; 2 screws M 1.7 x 8; 1 cover plate

Code	 g	
19 01 00 00	26	1

4150QR Spare parts set for ratchets No 415QR, 415QRL, 415SG-QR



Content:

- 1 pinion; 1 pawl; 2 levers with pin; 1 ball; 2 compression springs; 2 screws M 1.7 x 8; 2 cover plates

Code	 g	
19 01 10 20	24	1

4150QR N Spare parts set for ratchet No 415QR N, 415QRL N, 415SG-QR N



Content:

- 1 pinion; 1 locking disc; 1 lever; 1 pin; 1 ball; 1 compression spring; 2 circlips; 1 cover plate

Code	 g	
19 01 20 20	21	1

4150B Spare parts set for ratchets No 415B, 415SGB

Content:

- 1 pinion; 1 pawl; 1 lever with pin; 1 ball; 2 compression springs; 2 screws M 1.7 x 8; 1 cover plate

Code	 g	
19 01 00 11	20	1

Sockets, Socket Sets

6.3
1/4"

DIN
3120

ISO
1174-1

400 Drive handle

DIN 3122/ISO 3315.



Code	L mm	g	g	g
11 05 00 10	150	70	5	

400QR QuickRelease drive handle

QR

DIN 3122/ISO 3315,
with QuickRelease safety lock,
patent.



Code	L mm	g	g	g
11 05 10 10	150	80	1	

400 Drall Drive handle

with 3/4" square drive in end of
handle, DIN 3122/ISO 3315.



Code	L mm	g	g	g
11 05 00 11	150	106	5	

401 Drive handle

flexible shaft (right hand rotation only), maximum torque 5 N-m.



Code	L mm	g	g	g
11 05 30 02	240	130	5	

403 Flexible handle

DIN 3122/ISO 3315, with 2-component handle.



Code	L mm	g	g	g
11 06 10 10	154.5	70	1	

404 Sliding T-handle

DIN 3122/ISO 3315.



Code	L mm	g	g	g
11 07 00 00	116	38	5	

404QR QuickRelease sliding T-handle

QR

with QuickRelease safety locks,
patent.



Code	L mm	g	g	g
11 07 10 00	116	52	1	

413QR QuickRelease speeder brace

NEW

QR

with steel handle,
for greater axial power transmission, detachable palm head, working
radius 70 mm, with QuickRelease safety lock, patent.



Code	L mm	g	g	g
11 10 00 05	440	352	1	

405 Extensions

DIN 3123/ISO 3316.

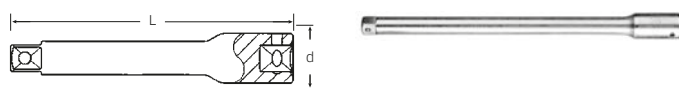

Code	size	L mm	d mm	g	g
11 01 00 01	2	54	11.6	29	5
11 01 00 06	4	100	11.6	46	5
11 01 00 02	6	150	11.6	65	5
11 01 00 10	10	254	11.6	115	1
11 01 00 14	14	356	11.6	155	1

405W Extensions with wobble-drive

swivel angle 8° each side, max. torque 40 N-m.

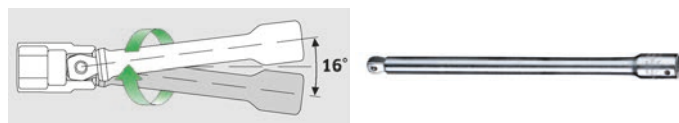

Code	size	L mm	d mm	g	g
11 01 00 11	2	54	11.6	28	1
11 01 00 16	4	100	11.6	45	1
11 01 00 12	6	150	11.6	55	1
11 01 00 20	10	254	11.6	110	1
11 01 00 24	14	356	11.6	155	1

405QR QuickRelease extensions

QR

patent, DIN 3123/ISO 3316.



Code	size	L mm	d mm	g	g
11 01 10 01	2	54	11.6	28	1
11 01 10 06	4	102	11.6	49	1
11 01 10 02	6	150	11.6	65	1
11 01 10 13	13	330	11.6	145	1
11 01 10 05	14	356	11.6	150	1

406 Extension, flexible

(right hand rotation only)
maximum torque 5 N·m.



Code	L mm	d mm	g	
11 04 0000	152	11.6	61	5

407 Universal joint

DIN 3123/ISO 3316.



Code	L mm	d mm	g	
11 02 0000	37	12.8	23	5

407QR QuickRelease universal joint

QR

with QuickRelease safety lock, patent.

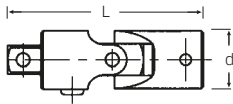

Code	L mm	d mm	g	
11 02 1000	45	13	35	1

5513 Set of adaptors

NEW

No 409, 1/4" socket x 3/8" plug
No 431, 3/8" socket x 1/4" plug
No 432, 3/8" socket x 1/2" plug
No 513, 1/2" socket x 3/8" plug
No 514, 1/2" socket x 3/4" plug



Code	g	
96 12 10 03	648	1

409 Adaptor

HPQ

1/4" socket x 3/8" plug (6.3 x 10),
DIN 3123/ISO 3316, HPQ® high performance steel.



Code	L mm	d mm	g	
11 03 0002	25	12.8	18	5

409M/432M/ 514M/3 Set adaptors, 3 pieces

1/4" socket x 3/8" plug,
3/8" socket x 1/2" plug,
1/2" socket x 3/4" plug.



Code	g	
96 12 10 02	120	1

409M Adaptor

1/4" socket x 3/8" plug (6.3 x 10).



Code	L mm	∅ mm	g	
11 03 00 10	13	28	14	1

410 Adaptor

HPQ

1/4" socket x 1/2" plug (6.3 x 12.5),
HPQ® high performance steel.



Code	L mm	d mm	g	
11 03 00 03	28	16.5	36	5

412 Bit holder

HPQ

1/4" inside hexagon, DIN 3126/ISO 1173 D 6.3.
Internal hex drive with a collar-thrust spring.
Bits are easy to insert, lock securely in position and can be removed just as easily; even hex bits with a wide groove (Type E, DIN 3126/ISO 1173).
HPQ® high performance steel.



Code	L mm	d mm	g	
11 18 00 10	25	11.6	15	5

412-1 Bit holder

HPQ

1/4" inside hexagon, DIN 3126/ISO 1173 D 6.3
Outer 10 mm for use in tools with 10 mm
internal hex drive or internal double hexagon
(e.g. "FLEXI" double-ended flexi-joint spanners, T-handle universal joint spanners, box spanners, ratchet ring spanners etc.).
Internal hex drive with a collar-thrust spring.
Bits are easy to insert, lock securely in position and can be removed just as easily; even hex bits with a wide groove (Type E, DIN 3126/ISO 1173).
HPQ® high performance steel.



Code	Außen ∅	L mm	d mm	g	
11 18 00 20	10 mm	20	11.6	11	5

417/1 Locking adaptor

with hexagon key wrench
No 10760aCV 3/32".



Code	L mm	d mm	g	
96 11 27 01	42	13	23	1

6.3
1/4"

DIN
3120

ISO
1174-1

3

Sockets, Socket Sets

6.3
1/4"

DIN
3120

ISO
1174-1

4008 Ratcheting BIT holder

- Easy change of direction (anticlockwise, clockwise and fixed) by simply twisting the locking ring
- Ergonomically designed, non-slip 2-component handle for optimum force transmission
- Storage compartment for 6 bits in the handle; push button to open (Size 1)
- For BITS screwdriver inserts with external hex 1/4" DIN 3126/ISO 1173 Type C 6.3
- 1/4" sockets can be used with Adaptor No 3115/1 (external hex and square drive 1/4")
- Easy bit change thanks to internal hex. drive with magnet
- Knurled spin section for faster screw advance
- Heavy-duty mechanism with 48 teeth (7.5° working angle)

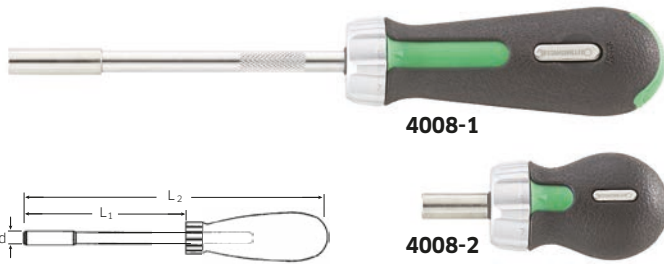

Code	size	inside O	"	L ₁ mm	L ₂ mm	d mm	g	g	g
18 12 0001	1	D 6.3	1/4	127	250	10	248	1	1
18 12 0002	2	D 6.3	1/4	25	95	10	137	1	1

inside O DIN 3126/ISO 1173

4008/27/1R Ratcheting BIT holder set

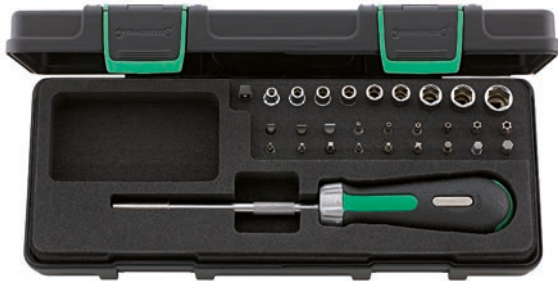

29 pieces

Content:

- 1 Ratcheting bit holder No 4008-1
- 3 Bits ⊕ 1221; 1222; 1223
- 3 Bits ⊕ PZ 1221; PZ 1222; PZ 1223
- 6 Bits ⊕ 1440 T10; 1441 T15; 1442 T20; 1443 T25; 1445 T30; 1446 T40
- 3 Bits ⊕ 1301; 1302; 1303
- 3 Bits ⊖ 1163 0.6 x 4.5; 1165 0.8 x 5.5; 1166/1 1.2 x 6.5 mm
- 1 Square drive extension No 3115/1 with 1/4" outer hex. and outer square drives for attaching 1/4" □ sockets
- 9 Sockets No 40. 1/4" □ sizes 4; 5; 5.5; 6; 7; 8; 10; 11; 13 mm

Code	g	g
96 18 2203	642	1

Tools for Hi-Lok bolts

40aD/8/1H Socket set

for Hi-Lok bolts.

Content:

- 5 sockets with bi-hexagon No 40aD: sizes 7/32; 1/4; 5/16; 11/32; 3/8"
- 3 offset screwdrivers No 10759a: 1/16; 5/64; 3/32"
- 1 ratchet No 415SGH



Code	g	g
96 01 63 03	638	1

415SGH N Hi-Lok-ratchet, fine tooth

FSD



reversible, 80 teeth, patent, axially drilled pinion, locking facility for sockets. For use on Hi-Lok bolts in the aerospace industry, for use in confined spaces, re-engages after movement of 4.5°, construction without screws prevents foreign object damage.

Code	L mm	b mm	a mm	g	g
11 11 00 10	117	22.6	10.7	90	5

414H Hi-Lok extensions

with lock-on facility as on ratchet No 415SGH, patent.



Code	size	L mm	d mm	g	g
11 24 00 11	2	54	13	34	1
11 24 00 12	4	102	13	49	1
11 24 00 13	6	152	13	66	1

10759 Offset screwdrivers

with hexagon end for ratchet

No 415SGH, patent.

Round shaft on screwdriver enables locking of ball retainer.



Code	size	mm	L mm	g	g
43 06 20 02	1	2	50	5	5
43 06 40 02	2	2	100	8	5

10759a Offset screwdrivers

Code	size	"	L mm	g	g
43 56 00 04	1	1/16	50	5	5
43 56 40 04	2	1/16	100	8	5
43 56 00 05	1	5/64	50	5	5
43 56 40 05	2	5/64	100	8	5
43 56 00 06	1	3/32	50	5	5
43 56 40 06	2	3/32	100	8	5

40/20/4QR SCI Socket set 1/4" □

in softcase with foam inlay,
24 pieces
Content:

- 10 sockets with hexagon No 40:
sizes 5; 5.5; 6; 7; 8; 9; 10; 11; 12;
13 mm
- 2 bits ⊕ 1221: size 1; 1222: size 2
- 3 bits ● 1301: 4 mm; 1302: 5 mm;
1303: 6 mm
- 5 bits ● 1414: T10; 1415: T15;
1416: T20; 1417: T25; 1419: T30
- 1 ratchet No 415QR N
- 2 extensions No 405QR/2 (54 mm), No 405QR/6 (150 mm)
- 1 bit-holder No 412



Code	ΔΔ g
96010127	565

40/9/4 Socket set 1/4" □

in sturdy, stackable ABS plastic case,
13 pieces
Content:

- 9 sockets with hexagon No 40:
sizes 4; 5; 5.5; 6; 7; 8; 10; 11;
13 mm
- 1 ratchet No 415
- 2 extensions
No 405/2 (54 mm),
No 405/6 (150 mm)
- 1 universal joint No 407

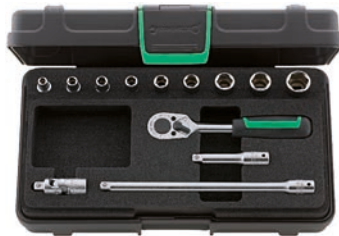

Code	ΔΔ g
96011119	717

40D/9/4 Socket set 1/4" □

in sturdy, stackable ABS plastic case,
13 pieces
Content:

- 9 sockets with bi-hexagon No 40D:
sizes 4; 5; 5.5; 6; 7; 8; 10; 11;
13 mm
- 1 ratchet No 415
- 2 extensions
No 405/2 (54 mm),
No 405/6 (150 mm)
- 1 universal joint No 407

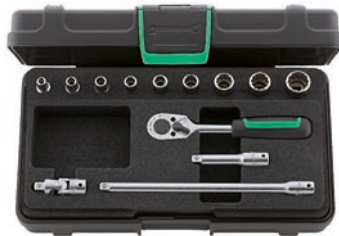

Code	ΔΔ g
96011304	749

40/13/6 Socket set 1/4" □

in sturdy, stackable ABS plastic case,
19 pieces
Content:

- 13 sockets with hexagon No 40:
sizes 3.5; 4; 4.5; 5; 5.5; 6; 7; 8; 9;
10; 11; 12; 13 mm
- 1 ratchet No 415
- 2 extensions No 405/2 (54 mm),
No 405/6 (150 mm)
- 1 universal joint No 407
- 1 drive handle No 400
- 1 T-handle No 404



Code	ΔΔ g
96011124	924

40/13/6QR Socket set 1/4" □

QR

in sturdy, stackable ABS plastic case,
19 pieces

- Content:
- 13 sockets with hexagon No 40:
sizes 3.5; 4; 4.5; 5; 5.5; 6; 7; 8; 9;
10; 11; 12; 13 mm
 - 1 ratchet No 415QR N
 - 2 extensions No 405QR/2 (54 mm),
No 405QR/6 (150 mm)
 - 1 universal joint No 407QR
 - 1 drive handle No 400QR
 - 1 T-handle No 404QR



Code	ΔΔ g
96011180	978

40/44/17/5 Socket set 1/4" □

in sturdy, stackable ABS plastic case,
22 pieces
Content:

- 13 sockets with hexagon No 40:
sizes 3.5; 4; 4.5; 5; 5.5; 6; 7; 8; 9;
10; 11; 12; 13 mm
- 4 INHEX sockets No 44:
sizes 3; 4; 5; 6 mm
- 1 ratchet No 415
- 1 extension No 405/6 (150 mm)
- 1 universal joint No 407
- 1 drive handle No 400
- 1 T-handle No 404



Code	ΔΔ g
96011113	968

40/44/17/5QR Socket set 1/4" □

QR

in sturdy, stackable ABS plastic case,
22 pieces

- Content:
- 13 sockets with hexagon No 40:
sizes 3.5; 4; 4.5; 5; 5.5; 6; 7; 8; 9;
10; 11; 12; 13 mm
 - 4 INHEX sockets No 44:
sizes 3; 4; 5; 6 mm
 - 1 ratchet No 415QR
 - 1 extension No 405/6QR (150 mm)
 - 1 universal joint No 407QR
 - 1 drive handle No 400QR
 - 1 T-handle No 404QR



Code	ΔΔ g
96011181	981

6.3
1/4"

DIN
3120

ISO
1174-1

3

Sockets, Socket Sets

6.3
1/4"

DIN
3120

ISO
1174-1

3

40/23/7 Socket set 1/4"

in sturdy, stackable ABS plastic case,
30 pieces

Content:

- 12 sockets with hexagon No 40:
sizes 4; 4.5; 5; 5.5; 6; 7; 8; 9; 10;
11; 12; 13 mm
- 4 INHEX sockets No 44:
sizes 3; 4; 5; 6 mm
- 3 bits ⊕ 1221: size 1; 1222: size 2; 1223: size 3
- 4 bits ⊖ 1162: 0.6 x 3.5 mm, 1164: 0.8 x 4 mm; 1166: 1 x 5.5 mm;
1168: 1.6 x 8 mm
- 1 ratchet No 415
- 2 extensions No 405/2 (54 mm), No 405/6 (150 mm)
- 1 universal joint No 407
- 1 drive handle No 400
- 1 T-handle No 404
- 1 bit-holder No 412



Code	⊕ ⊖ g
9601 1134	1287

40D/23/7 Socket set 1/4"

in sturdy, stackable ABS plastic case,
30 pieces

Content:

- 2 sockets with hexagon No 40:
sizes 4; 4.5 mm
- 10 sockets with bi-hexagon No 40D:
sizes 5; 5.5; 6; 7; 8; 9; 10; 11; 12;
13 mm
- 4 INHEX sockets No 44: sizes 3; 4; 5; 6 mm
- 3 bits ⊕ No 1221: size 1; No 1222: size 2; No 1223: size 3
- 4 bits ⊖ 1162: 0.6 x 3.5 mm; 1164: 0.8 x 4 mm; 1166: 1.0 x 5.5 mm;
1168: 1.6 x 8 mm
- 1 ratchet No 415
- 2 extensions No 405/2 (54 mm), No 405/6 (150 mm)
- 1 universal joint No 407
- 1 drive handle No 400
- 1 T-handle No 404
- 1 bit-holder No 412



Code	⊕ ⊖ g
9601 1305	1212

40/23/6 Socket set 1/4"

in sturdy, stackable ABS plastic case,
29 pieces

Content:

- 11 sockets with hexagon No 40:
sizes 5; 5.5; 6; 7; 8; 9; 10; 11; 12;
13; 14 mm
- 3 screwdriver sockets ⊖ No 41K:
sizes 0.6 x 3.5; 1.0 x 5.5;
1.2 x 8 mm,
- 5 INHEX sockets No 44K:
sizes 3; 4; 5; 6; 8 mm
- 4 screwdriver sockets ⊕ No 44P: sizes 1; 2; 3; 4
- 1 ratchet No 415
- 2 extensions No 405/2 (54 mm), No 405/6 (150 mm)
- 1 universal joint No 407
- 1 drive handle No 400
- 1 T-handle No 404



Code	⊕ ⊖ g
9601 1136	1064

40/23/6QR Socket set 1/4"

NEW

QR

in sturdy, stackable ABS plastic case,
29 pieces

Content:

- 11 sockets with hexagon No 40:
sizes 5; 5.5; 6; 7; 8; 9; 10; 11; 12;
13; 14 mm
- 3 screwdriver sockets ⊖ No 41K:
sizes 0.6 x 3.5; 1.0 x 5.5; 1.2 x 8 mm,
- 5 INHEX sockets No 44K:
sizes 3; 4; 5; 6; 8 mm
- 4 screwdriver sockets ⊕ No 44P: sizes 1; 2; 3; 4
- 1 ratchet No 415QR N
- 2 extensions No 405QR/2 (54 mm), No 405QR/6 (150 mm)
- 1 universal joint No 407QR
- 1 drive handle No 400QR
- 1 T-handle No 404QR



Code	⊕ ⊖ g
9601 1137	998

40D/23/6 Socket set 1/4"

in sturdy, stackable ABS plastic case,
29 pieces

Content:

- 11 sockets with bi-hexagon No 40D:
sizes 5; 5.5; 6; 7; 8; 9; 10; 11; 12;
13; 14 mm
- 3 screwdriver sockets ⊖ No 41K:
sizes 0.6 x 3.5; 1.0 x 5.5;
1.2 x 8 mm
- 5 INHEX sockets No 44K:
sizes 3; 4; 5; 6; 8 mm
- 4 screwdriver sockets ⊕ No 44P: sizes 1; 2; 3; 4
- 1 ratchet No 415
- 2 extensions No 405/2 (54 mm), No 405/6 (150 mm)
- 1 universal joint No 407
- 1 drive handle No 400
- 1 T-handle No 404



Code	⊕ ⊖ g
9601 1306	1017

40/24/6 Socket set 1/4"

in sturdy, stackable ABS plastic case,
30 pieces

Content:

- 12 sockets with hexagon No 40:
sizes 4; 5; 5.5; 6; 7; 8; 9; 10; 11;
12; 13; 14 mm
- 3 screwdriver sockets ⊖ No 41K:
0.6 x 3.5; 1.0 x 5.5; 1.2 x 8 mm
- 5 INHEX sockets No 44K:
sizes 3; 4; 5; 6; 8 mm
- 2 screwdriver sockets ⊕ No 44P: sizes 1; 2
- 2 screwdriver sockets ⊕ No 44PZ: sizes 1; 2
- 1 ratchet No 415
- 2 extensions No 405/2 (54 mm), No 405/6 (150 mm)
- 1 universal joint No 407
- 1 drive handle No 400
- 1 T-handle No 404



Code	⊕ ⊖ g
9601 1138	1058

40/24/6QR Socket set 1/4"

QR

in sturdy, stackable ABS plastic case, 30 pieces

Content:

- 12 sockets with hexagon No 40: sizes 4; 5; 5.5; 6; 7; 8; 9; 10; 11; 12; 13; 14 mm
- 3 screwdriver sockets \ominus No 41K: 0.6 x 3.5; 1.0 x 5.5; 1.2 x 8 mm
- 5 INHEX sockets No 44K: sizes 3; 4; 5; 6; 8 mm
- 2 screwdriver sockets \oplus No 44P: sizes 1; 2
- 2 screwdriver sockets \oplus No 44PZ: sizes 1; 2
- 1 ratchet No 415QR N
- 2 extensions No 405QR/2 (54 mm), No 405QR/6 (150 mm)
- 1 universal joint No 407QR
- 1 drive handle No 400QR
- 1 T-handle No 404QR



Code	⚙ g
96011182	1093

40/52/27/11 Socket set 1/4; 1/2"

in sturdy, stackable ABS plastic case, 38 pieces

Content:

- 9 sockets with hexagon No 40: sizes 4; 5; 5.5; 6; 7; 8; 9; 10; 11 mm
- 10 sockets with hexagon No 52: sizes 13; 16; 17; 18; 19; 21; 22; 24; 27; 30 mm
- 3 INHEX sockets No 44: sizes 3; 4; 5 mm
- 5 INHEX sockets No 54: sizes 6; 8; 10; 12; 14 mm
- 2 ratchets No 415, No 512
- 4 extensions No 405/2 (54 mm), No 509/5 (130 mm), No 405/6 (150 mm), No 509/10 (255 mm)
- 2 universal joints No 407, No 510
- 1 drive handle No 400
- 2 T-handles No 404, No 506



Code	⚙ g
96011160	5145

40ma/25/8 Socket set 1/4"

in sturdy, stackable ABS plastic case, 33 pieces

Content:

- 25 sockets with hexagon
 - No 40: sizes 3.2; 3.5; 4; 4.5; 5; 5.5; 6; 7; 8; 9; 10; 11; 12; 13; 14 mm
 - No 40a: sizes 3/16; 7/32; 1/4; 9/32; 5/16; 11/32; 3/8; 7/16; 1/2; 9/16"
- 1 ratchet No 415
- 2 extensions No 405/2 (54 mm), No 405/6 (150 mm)
- 1 extension, flexible No 406 (152 mm)
- 1 universal joint No 407
- 1 drive handle No 400
- 1 flexible handle No 403
- 1 T-handle No 404



Code	⚙ g
96011162	1484

40ma/25/8QR Socket set 1/4"

NEW

QR

in sturdy, stackable ABS plastic case, 33 pieces

Content:

- 25 sockets with hexagon
 - No 40: sizes 3.2; 3.5; 4; 4.5; 5; 5.5; 6; 7; 8; 9; 10; 11; 12; 13; 14 mm
 - No 40a: sizes 3/16; 7/32; 1/4; 9/32; 5/16; 11/32; 3/8; 7/16; 1/2; 9/16"
- 1 ratchet No 415QR N
- 2 extensions No 405QR/2 (54 mm), No 405QR/6 (150 mm)
- 1 extension, flexible No 406QR (152 mm)
- 1 universal joint No 407QR
- 1 drive handle No 400QR
- 1 flexible handle No 403
- 1 T-handle No 404QR



Code	⚙ g
96010107	1484

40/45/36/12 Socket set 1/4; 3/8"

in sturdy, stackable ABS plastic case, 48 pieces

Content:

- 8 sockets with hexagon No 40: sizes 4; 4.5; 5; 5.5; 6; 7; 8; 9 mm
- 12 sockets with bi-hexagon No 45: sizes 10; 11; 12; 13; 14; 15; 16; 17; 18; 19; 21; 22 mm
- 1 socket with bi-hexagon, long, with rubber insert No 4600: size 16 mm - 5/8"
- 3 bits \oplus 1221: size 1; 1222: size 2; 1223: size 3
- 1 bit \oplus PZ1222: size 2
- 6 bits \ominus 1160: 0.5 x 3 mm; 1162: 0.6 x 3.5 mm; 1164: 0.8 x 4 mm; 1166: 1.0 x 5.5 mm; 1166/1: 1.2 x 6.5 mm; 1168: 1.6 x 8 mm
- 5 bits \bullet 1300: 3 mm; 1301: 4 mm; 1302: 5 mm; 1303: 6 mm; 1304: 8 mm
- 2 ratchets No 415, No 435
- 3 extensions No 427/3 (76 mm), No 405/6 (150 mm), No 427/10 (240 mm)
- 2 universal joints No 407, No 428
- 1 drive handle No 400
- 1 T-handle No 425
- 2 bit-holder No 412, No 442
- 1 adaptor No 431



Code	⚙ g
96012047	2963



6.3
1/4"

DIN
3120

ISO
1174-1

3

Sockets, Socket Sets

6.3
1/4"

DIN
3120

ISO
1174-1

86TX Socket set TORX® 1/4; 1/2"

in sturdy, stackable ABS plastic case,
63 pieces

Content:

- 9 sockets with hexagon No 40:
sizes 4; 5; 5.5; 6; 7; 8; 9; 10;
11 mm
- 10 sockets with hexagon No 52:
sizes 13; 16; 17; 18; 19; 21; 22;
24; 27; 30 mm
- 5 sockets for external TORX® screws No 40TX:
sizes E4; E5; E6; E7; E8
- 7 sockets for external TORX® screws No 50TX:
sizes E10; E12; E14; E16; E18; E20; E24
- 3 INHEX sockets No 44: sizes 3; 4; 5 mm
- 5 INHEX sockets No 54: sizes 6; 8; 10; 12; 14 mm
- 6 screwdriver sockets for internal TORX® screws No 44KTX:
sizes T8; T9; T10; T15; T20; T25
- 7 screwdriver sockets for internal TORX® screws No 54TX:
sizes T27; T30; T40; T45; T50; T55; T60
- 2 ratchets No 415, No 512
- 4 extensions No 405/2 (54 mm), No 509/5 (130 mm),
No 405/6 (150 mm), No 509/10 (255 mm)
- 2 universal joints No 407, No 510
- 1 drive handle No 400



Code	g
9601 3702	6734

88TX Socket set TORX® 1/4"

in sturdy, stackable ABS plastic case,
36 pieces

Content:

- 10 sockets with hexagon No 40:
sizes 5; 5.5; 6; 7; 8; 9; 10; 11; 12;
13 mm
- 6 sockets for external TORX®
screws No 40TX: sizes E4; E5; E6;
E7; E8; E10
- 5 INHEX sockets No 44K: sizes 3; 4; 5; 6; 8 mm
- 9 screwdriver sockets for internal TORX® screws No 44KTX:
sizes T8; T9; T10; T15; T20; T25; T27; T30; T40
- 1 ratchet No 415
- 2 extensions No 405/2 (54 mm), No 405/6 (150 mm)
- 1 universal joint No 407
- 1 drive handle No 400
- 1 T-handle No 404

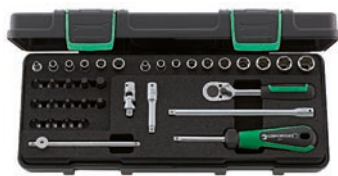

Code	g
9881 9801	1287

 Made in
Germany

89TX Socket set TORX® 1/4; 3/8; 1/2"

in sturdy, stackable ABS plastic case,
35 pieces

Content:

- 3 sockets for external TORX®
screws No 40TX:
sizes E4; E5; E6
- 2 screwdriver sockets for internal
TORX® screws No 44KTX:
sizes T8; T9
- 4 sockets for external TORX® screws No 45TX:
sizes E7; E8; E10; E12
- 5 screwdriver sockets for internal TORX® screws No 49TX:
sizes T10; T15; T20; T25; T27
- 6 sockets for external TORX® screws No 50TX:
sizes E11; E14; E16; E18; E20; E24
- 6 screwdriver sockets for internal TORX® screws No 54TX:
sizes T30; T40; T45; T50; T55; T60
- 7 bits  1440: T10; 1441: T15; 1442: T20; 1443: T25; 1444: T27;
1445: T30; 1446: T40
- 1 bit-holder No 442
- 1 TORX® controller: sizes E6; E7; E8; E10; E12; E14; E16; T10; T15; T20;
T25; T27; T30; T40; T45; T47; T50; T55; T60

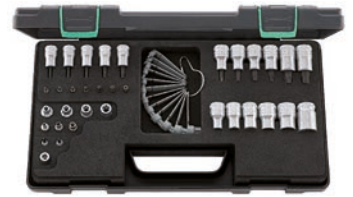

Code	g
9881 1908	2568

40TX/44KTX/15/6 Socket set TORX® 1/4"

in sturdy, stackable ABS plastic case,
21 pieces

Content:

- 6 sockets for external TORX®
screws No 40TX:
sizes E4; E5; E6; E7; E8; E10
- 9 screwdriver sockets for internal
TORX® screws No 44KTX:
sizes T8; T9; T10; T15; T20; T25;
T27; T30; T40
- 1 ratchet No 415
- 2 extensions No 405/2 (54 mm), No 405/6 (150 mm)
- 1 universal joint No 407
- 1 drive handle No 400
- 1 T-handle No 404



Code	g
9601 3701	896

40a/9/4 Socket set 1/4"

in sturdy, stackable ABS plastic case,
13 pieces

Content:

- 9 sockets with hexagon No 40a:
sizes 3/16; 7/32; 1/4; 9/32; 5/16; 11/32;
3/8; 7/16; 1/2"
- 1 ratchet No 415
- 2 extensions
No 405/2 (54 mm),
No 405/6 (150 mm)
- 1 universal joint No 407

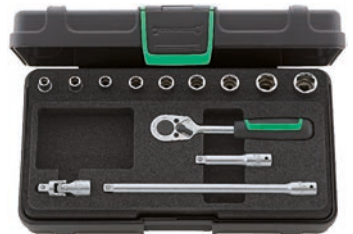

Code	g
9601 5107	817

40aD/9/4 Socket set 1/4"

in sturdy, stackable ABS plastic case, 13 pieces

Content:

- 9 sockets with bi-hexagon
 - No 40aD: sizes 3/16; 7/32; 1/4; 9/32; 5/16; 11/32; 3/8; 7/16; 1/2"
- 1 ratchet No 415
- 2 extensions
 - No 405/2 (54 mm),
 - No 405/6 (150 mm)
- 1 universal joint No 407

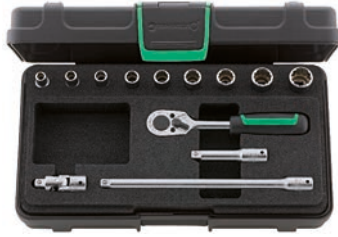

Code	Δ g
96016302	727

40aD/12/7QR Socket set 1/4"



in sturdy, stackable ABS plastic case, 19 pieces

Content:

- 1 socket with hexagon No 40a: size 1/8"
- 11 sockets with bi-hexagon
 - No 40aD: sizes 5/32; 3/16; 7/32; 1/4; 9/32; 5/16; 11/32; 3/8; 7/16; 1/2; 9/16"
- 1 ratchet No 415SG-QR N
- 3 extensions No 405/2QR (2x) (54 mm), No 405/6QR (150 mm)
- 1 universal joint No 407QR
- 1 drive handle No 400QR
- 1 bit-holder No 412



Code	Δ g
96015208	917

40aD/30/7QR Socket set 1/4"



in sturdy, stackable ABS plastic case, 37 pieces

Content:

- 1 socket with hexagon No 40a: size 1/8"
- 11 sockets with bi-hexagon
 - No 40aD: sizes 5/32; 3/16; 7/32; 1/4; 9/32; 5/16; 11/32; 3/8; 7/16; 1/2; 9/16"
- 11 sockets with bi-hexagon, long, No 40aDL: sizes 5/32; 3/16; 7/32; 1/4; 9/32; 5/16; 11/32; 3/8; 7/16; 1/2; 9/16"
- 7 UNIFLEX sockets with bi-hexagon No 402a: sizes 1/4; 9/32; 5/16; 11/32; 3/8; 7/16; 1/2"
- 1 ratchet No 415SG-QR N
- 3 extensions No 405/2QR (2x) (54 mm), No 405/6QR (150 mm)
- 1 universal joint No 407QR
- 1 drive handle No 400QR
- 1 bit-holder No 412

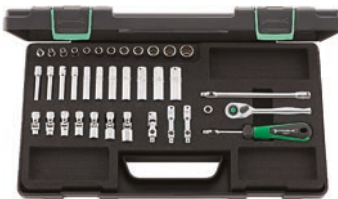

Code	Δ g
96015205	2168

ES 1/4" + 10760CV



175 x 350 x 41 mm, 27 pieces

Code	Δ g
96838110	1035
No 40	1/4" ○ sizes 5.5; 6; 7; 8; 9; 10; 11; 12; 13; 14 mm
No 400	1/4" ■ 150 mm
No 404	1/4" ■ 116 mm
No 405/2	1/4" ■ ○ 54 mm
No 405/6	1/4" ■ ○ 150 mm
No 407	1/4" ■ ○ 38 mm
No 412	1/4" ○ ○
No 415	1/4" ■
No 10760CV	sizes 1.5; 2; 2.5; 3; 4; 5; 6; 8; 10; 12 mm
83812028 Empty tray	107

TCS 1/4" + 10760CV

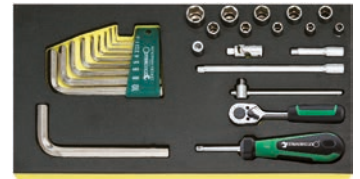
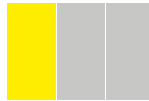

175 x 350 x 43 mm, 27 pieces

Code	Δ g
96838176	987
No 40	1/4" ○ sizes 5.5; 6; 7; 8; 9; 10; 11; 12; 13; 14 mm
No 400	1/4" ■ 150 mm
No 404	1/4" ■ 116 mm
No 405/2	1/4" ■ ○ 54 mm
No 405/6	1/4" ■ ○ 150 mm
No 407	1/4" ■ ○ 38 mm
No 412	1/4" ○ ○
No 415	1/4" ■
No 10760CV	sizes 1.5; 2; 2.5; 3; 4; 5; 6; 8; 10; 12 mm

6.3
1/4"

DIN
3120

ISO
1174-1

3

Sockets, Socket Sets

6.3
1/4"

DIN
3120

ISO
1174-1

3

TCS 40/41/44/8



TCS

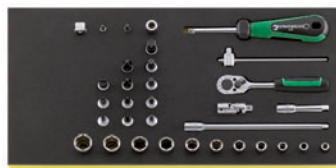

175 x 350 x 45 mm, 33 pieces

Code		g
96 83 02 17		715
No 40	1/4" sizes 5; 5.5; 6; 7; 8; 9; 10; 11; 12; 13; 14 mm	
No 41K	1/4" 0.6 x 3.5; 1.0 x 5.5; 1.2 x 8 mm	
No 44K	1/4" 3; 4; 5; 6; 8 mm	
No 44P	1/4" sizes 1; 2; 3; 4	
No PZ1221 No PZ1222	1/4" size 1 1/4" size 2	
No 400	1/4" 150 mm	
No 404	1/4" 116 mm	
No 405/2	1/4" 54 mm	
No 405/6	1/4" 150 mm	
No 407	1/4" 38 mm	
No 409	3/8" 1/4"	
No 412	1/4"	
No 415	1/4"	

TCS 40/35/9



TCS



175 x 350 x 40 mm, 44 pieces

Code		g
96 83 06 01		1045
No 40	1/4" sizes 5; 5.5; 6; 7; 8; 9; 10; 11; 12; 13; 14 mm	
No 40L	1/4" sizes 4; 4.5; 5; 5.5; 6; 7; 8; 9; 10; 11; 12; 13 mm	
No 41K	1/4" 0.6 x 3.5; 1.0 x 5.5; 1.2 x 8 mm	
No 44K	1/4" 3; 4; 5; 6; 8 mm	
No 44P	1/4" sizes 1; 2; 3; 4	
No 400	1/4" 150 mm	
No 404	1/4" 116 mm	
No 405/2 No 405/4	1/4" 54 mm 1/4" 100 mm	
No 405/6	1/4" 150 mm	
No 407	1/4" 38 mm	
No 412	1/4"	
No 415	1/4"	
No 409	3/8" 1/4"	



45 Sockets



metric sizes: DIN 3124/ISO 2725-1, ASME B 107.5M, E DIN EN 3709,
American sizes: ASME B 107.1, Fed. Spec. GGG-W-641,
SAE AS 954-E (test loads), HPQ® high performance steel, chrome plated.

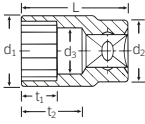

Code	Ø	d ₁	d ₂	d ₃	L	t ₁	t ₂	g	g
	mm	mm	mm	mm	mm	mm	mm		
02010007	7	10.5	16.5	6	24	6	12.5	19	10
02010008	8	11.7	16.5	7	25	7	13.5	19	10
02010009	9	13	16.5	8	25	7	13.5	19	10
02010010	10	14.3	16.5	9	27	8.5	15.5	20	10
02010011	11	15.6	16.5	10	27	8.5	13.7	21	10
02010012	12	16.9	17.5	11	28	9.5	14.4	24	10
02010013	13	18	17.5	12	30	11.5	16.1	30	10
02010014	14	19.4	17.5	13	30	11.5	15.8	28	10
02010015	15	20.6	19	14	31	12.5	19.2	40	10
02010016	16	21.7	19	15	31	13.5	18.9	33	10
02010017	17	23	19	16	31	12.5	18.6	44	10
02010018	18	24.2	19	17	32	13.5	19.3	39	5
02010019	19	25.2	19	18	32	13.5	19	39	5
02010020	20	26.2	20	19	34	15.5	20.7	51	5
02010021	21	27.7	21	20	34	15.5	20.5	53	5
02010022	22	28.7	21	21	35	17	21.2	61	5
02010024	24	31.5	24	21	35	18	21.2	92	5

45a Sockets

Code	Ø	d ₁	d ₂	d ₃	L	t ₁	t ₂	g	g
	"	mm	mm	mm	mm	mm	mm		
02410016	1/4	9.7	16.5	5.2	24	6	12.5	18	10
02410020	5/16	11.7	16.5	7	25	7	13.5	19	10
02410022	11/32	12.5	16.5	8.1	25	7	13.5	19	10
02410024	3/8	13.7	16.5	8.4	27	8.5	15.5	20	10
02410028	7/16	15.7	16.5	10	28	9.5	15.1	20	10
02410032	1/2	18	17.5	11.5	30	11.5	16.5	24	10
02410034	9/16	20.2	19	13.1	31	12.7	16.8	28	10
02410035	19/32	20.6	19	14	31	13	19.2	36	5
02410036	5/8	21.7	19	15	31	13.5	18.9	31	5
02410038	11/16	23.4	19	16.3	32	14.7	19.5	34	5
02410040	3/4	25.2	19	18	32	15.9	19	41	5
02410042	13/16	27.2	20.5	19.4	34	16.5	20.5	52	5
02410044	7/8	28.7	22	21	35	18	21	59	5
02410046	15/16	31.5	24	22.6	35	18.5	20.7	95	5
02410048	1	33	25.5	24.2	35	18.5	20.2	97	5

STAHLWILLE »AS-Drive«



STAHLWILLE sockets are equipped with the AS-Drive* profile: this permits high transmission of forces to the lands of nuts and bolts without damaging them. No longer will you have to worry about stripping the corners off nuts and bolts.

*Anti-Slip-Drive

456 Sockets



DIN 3124/ISO 2725-1, ASME B 107.5M, E DIN EN 3709 (test loads),
HPQ® high performance steel, chrome plated.

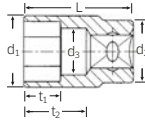

Code	Ø	d ₁	d ₂	d ₃	L	t ₁	t ₂	g	g
	mm	mm	mm	mm	mm	mm	mm		
02110007	7	10.5	16.5	6	24	6	12.5	19	10
02110008	8	11.7	16.5	7	25	7	13.5	19	10
02110009	9	13	16.5	8	25	7	13.5	20	10
02110010	10	14.3	16.5	9	27	8.5	15.5	20	10
02110011	11	15.6	16.5	10	27	8.5	13.7	21	10
02110012	12	16.9	17.5	11	28	9.5	14.4	24	10
02110013	13	18	17.5	12	30	11.5	16.1	25	10
02110014	14	19.4	17.5	13	30	11.5	15.8	29	10
02110015	15	20.6	19	14	31	12.5	19.2	30	10
02110016	16	21.7	19	15	31	13.5	18.9	34	10
02110017	17	23	19	16	31	12.5	18.6	45	10
02110018	18	24.2	19	17	32	13.5	19.3	42	10
02110019	19	25.2	19.6	18	32	13.5	19	43	10
02110020	20	26.2	20.5	19	34	15.5	20.7	53	10
02110021	21	27.7	21.8	20	34	15.5	20.5	59	10
02110022	22	28.7	21	21	35	17	21.2	59	10

460a Sockets



SAE AS 954-E, S.B.A.C. AS 40610/40611, ASME B 107.1,
HPQ® high performance steel, chrome plated.

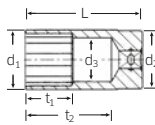

Code	Ø	d ₁	d ₂	d ₃	L	t ₁	t ₂	g	g
	"	mm	mm	mm	mm	mm	mm		
02620016	1/4	9.9	16.5	5.2	32	7	20.5	21	5
02620020	5/16	11.5	16.5	7	32	8.5	20.5	22	5
02620024	3/8	13.7	16.5	8.5	38	9	26.5	29	5
02620028	7/16	15.7	16.5	10	38	11	24.5	33	5
02620032	1/2	17.5	17.8	11.5	44	12	30	44	5

STAHLWILLE HPQ® sockets



STAHLWILLE HPQ® sockets are manufactured from selected tough steel alloys. The result: they are extremely durable. HPQ® sockets are free of cadmium and are therefore suitable for use on titanium alloy parts and titanium fasteners as used e.g. in the aerospace industry, where safety is a crucial factor.

*High Performance Quality

Sockets, Socket Sets

10
3/8"

DIN
3120

ISO
1174-1

46 Sockets



extra deep, metric sizes: DIN 3124/ISO 2725-1, E DIN EN 3710, E DIN EN 3709, ASME B 107.5M, American sizes: ASME B 107.1, Fed. Spec. GGG-W-641, SAE AS 954-E, HPQ® high performance steel, chrome plated.

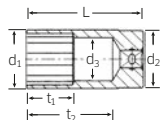

Code	mm/"	d ₁ mm	d ₂ mm	d ₃ mm	L mm	t ₁ mm	t ₂ mm	g	
02020008	8	11.7	16.5	7	54	9	42.5	36	10
02020010	10	14.3	16.5	9	54	20	42.5	41	10
02020011	11	15.6	16.5	10	54	20	40.7	51	10
02020012	12	16.9	17.5	11	54	20	40.4	57	10
02020013	13	18	17.5	12	54	20	40.1	61	10
02020014	14	19.4	17.5	13	60	25	45.8	75	10
02020015	15	20.6	19	14	60	25	48.2	85	10
02020016	16	21.7	19.5	15	60	25	47.9	81	10
02020017	17	23	21	16	65	30	52.6	97	10
02020018	18	24.2	22	17	65	30	52.3	121	10
02020019	19	25.2	23	18	65	30	52	112	10
02020208	20.8-13/16 ¹⁾	27.2	25	-	65	18	-	151	10
02020021	21	27.7	25.5	20	65	30	51.5	137	5
02020022	22	28.7	26.5	21	65	30	51.2	178	5

¹⁾ with rubber insert for spark plugs

46a Sockets

Code	mm/"	d ₁ mm	d ₂ mm	d ₃ mm	L mm	t ₁ mm	t ₂ mm	g	
02420016	1/4	9.7	16.5	5.2	54	9	42.5	33	5
02420020	5/16	11.7	16.5	7	54	9	42.5	35	5
02420022	11/32	12.5	16.5	8.1	54	9	42.5	37	5
02420024	3/8	13.7	16.5	8.4	54	20	42.5	45	5
02420028	7/16	15.7	16.5	10	54	20	40.7	53	5
02420032	1/2	18	17.5	11.5	54	20	40.2	64	5
02420034	9/16	20.2	19	13.1	60	25	45.8	66	5
02420035	19/32	20.6	19	14	60	25	48.2	84	5
02420036	5/8	21.7	19.5	15	60	25	47.9	81	5
02420038	11/16	23.4	21.5	16.3	65	30	52.5	114	5
02420040	3/4	25.2	23	18	65	30	52	137	5
02420042	13/16	27.2	25	19.4	65	30	51.6	130	5
02420044	7/8	28.7	26.5	21	65	30	51.2	184	5
02420046	15/16	31.5	29	22.6	65	30	50.7	195	5
02420048	1	33	31	24.2	65	30	50.2	205	5

5100 Rubber insert

for size 20.8 mm (No 46; 51; 51S).

Code	g	
09010001	6	5



3466 Spark plug socket



extra deep, with magnet, HPQ® high performance steel, chrome plated.

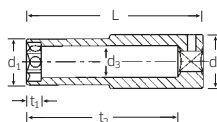

Code	mm/"	d ₁ mm	d ₂ mm	d ₃ mm	L mm	t ₁ mm	t ₂ mm	g	
02140036	16-5/8	21.8	25.5	15	85	7	72.9	180	5

4600 Spark plug socket



extra deep, with rubber insert, HPQ® high performance steel, chrome plated.

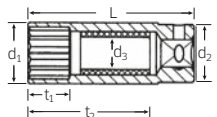

Code	mm/"	d ₁ mm	d ₂ mm	L mm	t ₁ mm	t ₂ mm	g	
02120036	16-5/8	21.7	19.5	60	15	47.8	88	10

4606 Spark plug socket



extra deep, with rubber insert, HPQ® high performance steel, chrome plated.

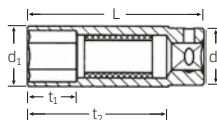

Code	mm/"	d ₁ mm	d ₂ mm	L mm	t ₁ mm	t ₂ mm	g	
02130018	18-11/16	24.2	22	65	18	52.8	132	10

Assembly of spark plugs on motorcycles, mopeds

47 UNIFLEX sockets



SAE AS 954-E (American sizes), HPQ® high performance steel, chrome plated.

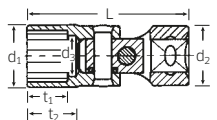

Code	mm	d ₁ mm	d ₂ mm	d ₃ mm	L mm	t ₁ mm	t ₂ mm	g	
02040010	10	14.3	17.5	9	45.5	7	12	51	1
02040011	11	15.6	17.5	10	47.5	11	14	55	1
02040012	12	16.9	17.5	11	48	11	14.5	54	1
02040013	13	18.3	17.5	12	48	12	14.5	53	1
02040014	14	19.4	17.5	13	48.5	13	14.5	55	1
02040015	15	20.6	17.5	14	48.5	13	14.5	56	1
02040016	16	21.8	17.5	15	51.5	14	17	58	1
02040017	17	23	17.5	16	53.5	15	18.5	63	1
02040018	18	24.2	17.5	17	54.5	16	18.5	61	1
02040019	19	25.5	17.5	18	57	16	21	68	1

47a UNIFLEX sockets

Code	"	d ₁ mm	d ₂ mm	d ₃ mm	L mm	t ₁ mm	t ₂ mm	Δg	g	
02 44 00 20	5/16	11.7	17.5	7	45.5	7	12.5	50	1	
02 44 00 24	3/8	13.7	17.5	8.5	45.5	7	12	50	1	
02 44 00 28	7/16	15.8	17.5	10	47.5	11	14	50	1	
02 44 00 32	1/2	18.3	17.5	11.5	47.5	11.5	14	57	1	
02 44 00 34	9/16	19.7	17.5	13.1	48.5	13	14.5	55	1	
02 44 00 36	5/8	21.6	17.5	15	51.5	14	17	59	1	
02 44 00 38	11/16	23.5	17.5	16.3	53.5	16	18.5	58	1	
02 44 00 40	3/4	25.5	17.5	18	57	16	21	67	1	

45TX Sockets

HPQ

for external TORX® screws, HPQ® high performance steel, chrome plated.

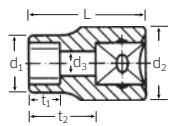

Code	size	mm	d ₁ mm	d ₂ mm	d ₃ mm	L mm	t ₁ mm	t ₂ mm	Δg	g	
02 27 00 05	E5	4.7	7	16.5	2.8	28	5	16.5	23	10	
02 27 00 06	E6	5.7	8	16.5	3.6	28	5.5	16.5	23	10	
02 27 00 07	E7	6.2	9	16.5	3.8	28	6.5	16.5	24	10	
02 27 00 08	E8	7.5	10.5	16.5	4.3	28	7	16.5	22	10	
02 27 00 10	E10	9.4	13	16.5	5.6	28	8	16.5	27	10	
02 27 00 12	E12	11.1	14.9	16.5	7.2	28	9.5	16.5	28	10	
02 27 00 14	E14	12.9	16.5	17.3	8	28	10	16.5	34	10	

45TX/7 Set: Sockets

HPQ

for external TORX® screws.
Content: E5; E6; E7; E8; E10; E12; E14



Code	Δg	g	
96 02 27 02		219	1

packed in carton

47TX UNIFLEX sockets

for external TORX® screws, Chrome Alloy Steel, chrome plated.

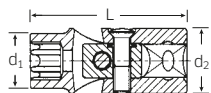

Code	size	mm	d ₁ mm	d ₂ mm	L mm	Δg	g	
02 07 00 08	E8	7.5	11.5	19	43	56	1	
02 07 00 10	E10	9.4	13.8	19	44	61	1	
02 07 00 12	E12	11.1	16	19	46	66	1	
02 07 00 14	E14	12.9	17.8	19	48	75	1	

45aSP Sockets spline-drive

HPQ

MS-33787, MIL-W-8982, HPQ® high performance steel, chrome plated.

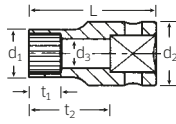

Code	Spline size	"	d ₁ mm	d ₂ mm	d ₃ mm	L mm	t ₁ mm	t ₂ mm	Δg	g	
02 01 10 12	12	3/8	13.7	16.5	8.6	26.5	9	15	24	1	
02 01 10 14	14	7/16	16	17.3	10.4	28	11	14.5	37	1	
02 01 10 16	16	1/2	18	18.3	12.2	28	11.5	14	28	1	

45aPSP Socket spline-drive

HPQ

MS-33787, MIL-W-8982, for disassembling jet engines, series CFM 56, HPQ® high performance steel, gunmetal finish.

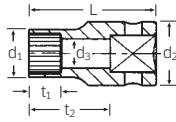

Code	Spline size	"	d ₁ mm	d ₂ mm	d ₃ mm	L mm	t ₁ mm	t ₂ mm	Δg	g	
22 41 00 28	14	7/16	18.8	18.8	10.4	28	11	14.5	36	10	

46aSP Sockets spline-drive

HPQ

extra deep bolt clearance, MS-33787, MIL-W-8982, HPQ® high performance steel, chrome plated.

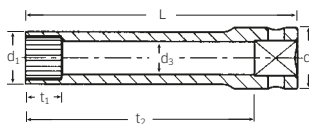

Code	Spline size	"	d ₁ mm	d ₂ mm	d ₃ mm	L mm	t ₁ mm	t ₂ mm	Δg	g	
02 02 10 12	12	3/8	13.7	16.5	8.6	54	9	42.5	52	1	
02 02 10 14	14	7/16	16	17.3	10.4	54	11	42.5	63	1	

45aP Socket

AS DRIVE

HPQ

ASME B 107.1, Fed. Spec. GGG-W-641, SAE AS 954-E (test loads), for disassembling jet engines, series CFM 56, HPQ® high performance steel, gunmetal finish.

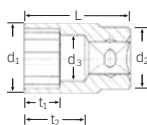

Code	"	d ₁ mm	d ₂ mm	d ₃ mm	L mm	t ₁ mm	t ₂ mm	Δg	g	
02 43 00 20	5/16	11.9	16.5	8.1	25	7	13.5	19	10	

10
3/8"

DIN
3120

ISO
1174-1

3

Sockets, Socket Sets

10
3/8"

DIN
3120

ISO
1174-1

3

49 INHEX sockets

for socket head screws, DIN 7422, Chrome Alloy Steel, chrome plated.

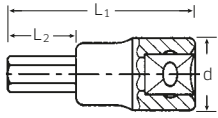

Code	mm	L ₁ mm	L ₂ mm	d mm	g	
02 05 00 03	3	52	20	17.8	38	5
02 05 00 04	4	52	20	17.8	40	5
02 05 00 05	5	52	20	17.8	44	5
02 05 00 06	6	52	20	17.8	46	5
02 05 00 07	7	52	20	17.8	51	5
02 05 00 08	8	52	20	17.8	55	5
02 05 00 10	10	52	20	17.8	62	5

49a INHEX sockets

Code	"	L ₁ mm	L ₂ mm	d mm	g	
02 45 00 08	1/8	52	20	17.8	39	5
02 45 00 09	9/64	52	20	17.8	40	5
02 45 00 10	5/32	52	20	17.8	40	5
02 45 00 12	3/16	52	20	17.8	44	5
02 45 00 14	7/32	52	20	17.8	46	5
02 45 00 16	1/4	52	20	17.8	48	5
02 45 00 20	5/16	52	20	17.8	55	5
02 45 00 24	3/8	52	20	17.8	61	5

2049 INHEX sockets

for socket head screws, extra long, DIN 7422, Chrome Alloy Steel, chrome plated.



Code	mm	L ₁ mm	L ₂ mm	d mm	g	
02 15 10 04	4	100	68	17.8	45	5
02 15 10 05	5	100	68	17.8	50	5
02 15 10 06	6	100	68	17.8	57	5
02 15 12 08	8	120	88	17.8	85	5
02 15 12 10	10	120	88	17.8	106	5

1049/3049 INHEX sockets

for socket head screws, DIN 7422, special lengths, Chrome Alloy Steel, chrome plated.



Code	No	mm	L ₁ mm	L ₂ mm	d mm	g	
02 15 10 07	1049/7	7	100	68	17.8	66	5
02 15 24 08	3049/8	8	24	6.5	19	28	5
02 15 10 09	1049/9 ¹⁾	9	57	25	17.8	62	5

¹⁾ For brake calliper retainers on BMW and MINI.

49TX Screwdriver sockets

for inside TORX® screws, Chrome Alloy Steel, chrome plated.

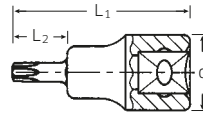

Code	size	mm	L ₁ mm	L ₂ mm	d mm	g	
02 10 00 09	T9	2.5	49	17	17.8	45	5
02 10 00 10	T10	2.7	49	17	17.8	45	5
02 10 00 15	T15	3.3	49	17	17.8	45	5
02 10 00 20	T20	3.8	49	17	17.8	46	5
02 10 00 25	T25	4.4	49	17	17.8	46	5
02 10 00 27	T27	5	49	17	17.8	46	5
02 10 00 30	T30	5.5	49	17	17.8	47	5
02 10 00 40	T40	6.6	49	17	17.8	48	5
02 10 00 45	T45	7.8	49	17	17.8	49	5

49TX/8 Set: Screwdriver sockets

for inside TORX® screws.

Content: T9; T10; T15; T20; T25; T27; T30; T40



Code	g	
96 02 10 01	456	1

packed in carton

49X Screwdriver sockets

for tri-square socket head screws (XZN®), DIN 2324, Chrome Alloy Steel, chrome plated.

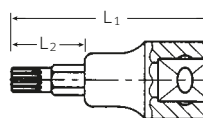

Code	size	L ₁ mm	L ₂ mm	d mm	g	
02 06 00 05	M5	52	20	17.8	45	5
02 06 00 06	M6	52	20	17.8	47	5
02 06 00 08	M8	52	20	17.8	56	5
02 06 00 10	M10	52	20	17.8	63	5

3049X Screwdriver sockets

for tri-square socket head screws (XZN®), extra long, DIN 2324, Chrome Alloy Steel, chrome plated.



Code	size	L ₁ mm	L ₂ mm	d mm	g	
02 26 12 06	NEW M6	120	88	17.8	80	5
02 26 12 08	M8	120	88	17.8	80	5
02 26 12 10	M10	120	88	17.8	106	5

45CL Clip strips

for socket retention, with 9 or 10 retaining clips.
Supplied without sockets.



Code	size	L mm	Δ g	
80 45 0001	1	200	40	5
80 45 0002	2	300	58	5

Drive tools and accessories

3/8" □, finish: Chrome Alloy Steel, chrome plated.

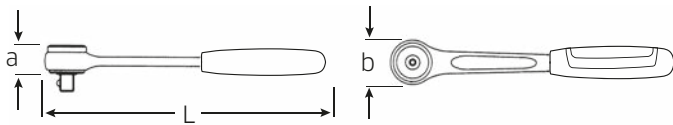

422 Ratchet

fine tooth, reversible, 60 teeth, with 2-component handle, for use in confined spaces, re-engages after movement of 6°, DIN 3122/ISO 3315.



Code	L mm	b mm	a mm	Δ g	
12 23 10 11	194	32	24	236	1

435 Ratchet

reversible, 30 teeth, with 2-component handle, DIN 3122/ISO 3315.



Code	L mm	b mm	a mm	Δ g	
12 11 10 10	193	29	18	245	5

435QR QuickRelease ratchet



reversible, 80 teeth, with QuickRelease safety lock and 2-component handle, DIN 3122/ISO 3315, DBGM.



Code	L mm	b mm	a mm	Δ g	
12 11 00 20	193	29	18	244	1

435QR N QuickRelease ratchet, fine tooth



reversible, 80 teeth, with QuickRelease safety lock and 2-component handle, for use in confined spaces, re-engages after movement of 4.5°, construction without screws prevents foreign object damage, DIN 3122/ISO 3315, registered design.



Code	L mm	b mm	a mm	Δ g	
12 11 10 20	193	30	15	235	1

435SG-QR N QuickRelease ratchet, fine tooth



reversible, 80 teeth, with QuickRelease safety lock and steel handle, for use in confined spaces, re-engages after movement of 4.5°, construction without screws prevents foreign object damage, DIN 3122/ISO 3315, registered design.

Code	L mm	b mm	a mm	Δ g	
12 11 10 30	193	30	15	266	1

445 Ratchet adaptor

reversible, 20 teeth.



Code	L mm	\varnothing mm	Δ g	
12 14 00 00	53	30	135	1

452QR QuickRelease fine-tooth flexible-joint ratchet



reversible, 80 teeth, with QuickRelease safety lock and 2-component handle, handle may be raised or lowered by approx. 90°. Lockable in following positions: straight, 30° up, 60° up, 30° down. Release the lock by pressing the button in the handle, for use in confined spaces, re-engages after movement of 4.5°, construction without screws prevents foreign object damage, DIN 3122/ISO3315, registered design.

Code	L mm	b mm	a mm	Δ g	
12 26 10 10	300	28.2	14.5	350	1

435QR N/6 Set of wrenches



in sturdy, stackable ABS plastic case, 6 pieces
Content:
1 ratchet No 435QR N
3 extensions No 427QR/3 (76 mm),
No 427QR/6 (160 mm),
No 427QR/10 (240 mm)
1 universal joint No 428QR
1 T-handle No 425QR



Code	Δ g
96 02 40 10	1375

7350/5 Spare parts set for ratchets No 422, 452

Content:
1 pinion; 1 pawl; 1 switching disk; 1 spring; 3 screws.

Code	Δ g	
59 25 10 05	85	1

4350 Spare parts set for ratchets No 435, 435SG, 438, 439

Content:
1 pinion; 1 pawl; 1 lever with pin; 1 ball;
2 compression springs; 2 screws

Code	Δ g	
19 02 00 00	50	1

Sockets, Socket Sets

10
3/8"

DIN
3120

ISO
1174-1

4350QR Spare parts set for ratchets No 435QR, 435SG-QR



Content:
1 pinion; 1 pawl; 1 lever with pin; 1 ball; 2 compression springs; 2 screws

Code	Δ g	
19020020	51	1

4350QR N Spare parts set for ratchets No 435QR N, 435SG-QR N



Content:
1 pinion; 1 locking disc; 1 lever; 1 pin; 1 ball; 1 compression spring;
2 circlips; 1 cover plate

Code	Δ g	
19021020	48	1

421 Speeder brace

working radius 85 mm,
DIN 3122/ISO 3315.



Code	L mm	Δ g	
12100010	386.5	385	5

453QR QuickRelease speeder brace



with steel handle,
for greater axial power
transmission, detachable palm head, working radius 85 mm,
DIN 3122/ISO 3315, with QuickRelease safety lock, patent.



Code	L mm	Δ g	
12100005	408	619	1

424 Flexible handle

DIN 3122/ISO 3315,
with 2-component handle.



Code	L mm	Δ g	
12061010	253.5	222	1

425 Sliding T-handle

DIN 3122/ISO 3315.

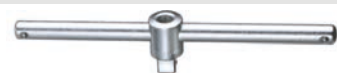

Code	L mm	Δ g	
12070000	165	133	5

425QR QuickRelease sliding T-handle



patent,
with QuickRelease safety lock.



Code	L mm	Δ g	
12071000	165	148	1

427 Extensions

DIN 3123/ISO 3316.

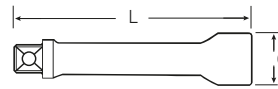

Code	size	L mm	d mm	Δ g	
12010005	1.5	38	17	36	5
12010001	3	76	17	67	5
12010006	5	125	17	104	5
12010002	6	160	17	127	5
12010003	10	240	17	188	5
12010004	18	455	17	345	5

427W Extensions with wobble-drive

swivel angle 15° each side,
max. torque 80 N-m.

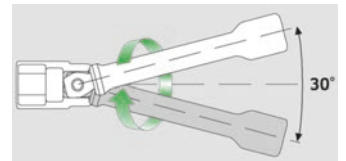

Code	size	L mm	d mm	Δ g	
12010007	3	76	17	67	5
12010008	5	125	17	104	5
12010009	6	160	17	127	5

427QR QuickRelease extensions



patent, DIN 3123/ISO 3316.



Code	size	L mm	d mm	Δ g	
12011001	3	76	17	66	1
12011002	6	160	17	127	1
12011003	10	240	17	185	1

433/1 Locking adaptor

with hexagon key wrench No 10760aCV 1/8".



Code	L mm	d mm	Δ g	
96122701	52	18	57	1

434 Extension, flexible

(right hand rotation only),
maximum torque 7 N-m.



Code	L mm	d mm	Δ g	
12 04 0000	194	17	109	5

1225 Special extension

offset



Code	L mm	d mm	Δ g	
12 25 0001	150	17	128	5

13220 Special extension

for removing Boroscope
plugs, with Boroscope plug locking,
external hexagon size 16 mm.



Code	L mm	Δ g	
12 27 0020	355	362	1

428 Universal joint

DIN 3123/ISO 3316.



Code	L mm	d mm	Δ g	
12 02 0000	46	18.8	55	5

428QR QuickRelease universal joint

QR

patent, DIN 3123/ISO 3316, with QuickRelease safety lock.

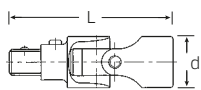

Code	L mm	d mm	Δ g	
12 02 1000	60	19	66	1

5513 Set of adaptors

No 409, 1/4" socket x 3/8" plug
No 431, 3/8" socket x 1/4" plug
No 432, 3/8" socket x 1/2" plug
No 513, 1/2" socket x 3/8" plug
No 514, 1/2" socket x 3/4" plug



Code	Δ g	
96 12 1003	648	1

431 Adaptor

HPQ

3/8" socket x 1/4" plug (10 x 6.3),
maximum torque 62 N-m, DIN 3123/ISO 3316,
HPQ® high performance steel.



Code	L mm	d mm	Δ g	
12 03 0001	28	17.2	26	5

432 Adaptor

HPQ

3/8" socket x 1/2" plug (10 x 12.5),
DIN 3123/ISO 3316, HPQ® high performance steel.



Code	L mm	d mm	Δ g	
12 03 0003	31	17.2	36	5

409M/432M/514M/3 Set adaptors, 3 pieces

1/4" socket x 3/8" plug,
3/8" socket x 1/2" plug,
1/2" socket x 3/4" plug.



Code	Δ g	
96 12 1002	120	1

432M Adaptor

3/8" socket x 1/2" plug
(10 x 12.5).



Code	L mm	\varnothing mm	Δ g	
12 03 00 10	16	32	22	1

442 Bit holder

⊙ 1/4" inside hexagon, DIN 3126/ISO 1173 D 6.3.
Internal hex drive with a collar-thrust spring.
Bits are easy to insert, lock securely in position and
can be removed just as easily; even hex bits with
a wide groove (Type E, DIN 3126/ISO 1173).



Code	L mm	d mm	Δ g	
12 18 00 26	32	16.5	30	5

443 Bit holder

⊙ 5/16" inside hexagon, DIN 3126/ISO 1173 D 8.
Internal hex drive with a collar-thrust spring.
Bits are easy to insert, lock securely in position and
can be removed just as easily; even hex bits with
a wide groove (Type E, DIN 3126/ISO 1173).



Code	L mm	d mm	Δ g	
12 18 00 30	32	16.5	39	5

Sockets, Socket Sets

10
3/8"

DIN
3120

ISO
1174-1

45/11/4 Socket set 3/8"

in sturdy, stackable ABS plastic case,
15 pieces
Content:

- 11 sockets with bi-hexagon No 45:
sizes 8; 10; 11; 12; 13; 14; 15;
16; 17; 18; 19 mm
- 1 ratchet No 435
- 2 extensions
No 427/3 (76 mm),
No 427/10 (240 mm)
- 1 universal joint No 428



Code	⚙ g
96021109	1434

456/11/4 Socket set 3/8"

in sturdy, stackable ABS plastic case,
15 pieces
Content:

- 11 sockets with hexagon No 456:
sizes 8; 10; 11; 12; 13; 14; 15;
16; 17; 18; 19 mm
- 1 ratchet No 435
- 2 extensions
No 427/3 (76 mm),
No 427/10 (240 mm)
- 1 universal joint No 428



Code	⚙ g
96022133	1454

45/14/5i Socket set 3/8"

in sturdy, stackable ABS plastic case,
19 pieces
Content:

- 14 sockets with bi-hexagon No 45:
sizes 8; 9; 10; 11; 12; 13; 14; 15;
16; 17; 18; 19; 21; 22 mm
- 1 ratchet No 435
- 2 extensions
No 427/3 (76 mm),
No 427/10 (240 mm)
- 1 T-handle No 425
- 1 universal joint No 428



Code	⚙ g
96024132	1698

456/14/5i Socket set 3/8"

in sturdy, stackable ABS plastic case,
19 pieces
Content:

- 14 sockets with hexagon No 456:
sizes 8; 9; 10; 11; 12; 13; 14; 15;
16; 17; 18; 19; 21; 22 mm
- 1 ratchet No 435
- 2 extensions
No 427/3 (76 mm),
No 427/10 (240 mm)
- 1 T-handle No 425
- 1 universal joint No 428

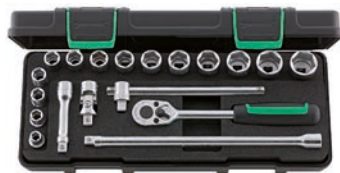

Code	⚙ g
96023132	1704

45/14/5iQR Socket set 3/8"

QR

in sturdy, stackable ABS plastic case,
19 pieces
Content:

- 14 sockets with bi-hexagon No 45:
sizes 8; 9; 10; 11; 12; 13; 14;
15; 16; 17; 18; 19; 21; 22 mm
- 1 ratchet No 435QR N
- 2 extensions No 427QR/3 (76 mm), No 427QR/10 (240 mm)
- 1 T-handle No 425QR
- 1 universal joint No 428QR



Code	⚙ g
96021180	1856

45/13/5 Socket set 3/8"

in sturdy, stackable ABS plastic case,
18 pieces
Content:

- 12 sockets with bi-hexagon No 45:
sizes 8; 9; 10; 11; 12; 13; 14; 15;
16; 17; 18; 19 mm
- 1 socket with bi-hexagon, long,
with rubber insert,
No 4600: size 16 mm - 5/8"
- 1 ratchet No 435
- 2 extensions No 427/3 (76 mm), No 427/10 (240 mm)
- 1 T-handle No 425
- 1 universal joint No 428

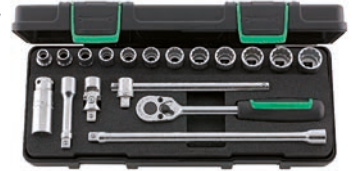

Code	⚙ g
96021234	1771

456/13/5 Socket set 3/8"

in sturdy, stackable ABS plastic case,
18 pieces
Content:

- 12 sockets with hexagon No 456:
sizes 8; 9; 10; 11; 12; 13; 14; 15;
16; 17; 18; 19 mm
- 1 socket with bi-hexagon, long,
with rubber insert, No 4600:
size 16 mm - 5/8"
- 1 ratchet No 435
- 2 extensions No 427/3 (76 mm), No 427/10 (240 mm)
- 1 T-handle No 425
- 1 universal joint No 428

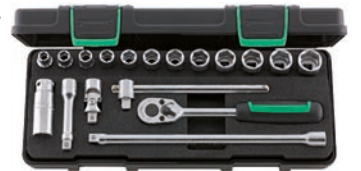

Code	⚙ g
96021202	1802

 Made in
Germany

45/49/19/5 Socket set 3/8" □

in sturdy, stackable ABS plastic case,
24 pieces

Content:

- 11 sockets with bi-hexagon No 45:
sizes 8; 10; 11; 12; 13; 14; 15;
16; 17; 18; 19 mm
- 1 socket with bi-hexagon, long,
with rubber insert No 4600:
size 16 mm - 5/8"
- 7 INHEX sockets No 49: sizes 3; 4; 5; 6; 7; 8; 10 mm
- 1 ratchet No 435
- 2 extensions No 427/3 (76 mm), No 427/10 (240 mm)
- 1 T-handle No 425
- 1 universal joint No 428

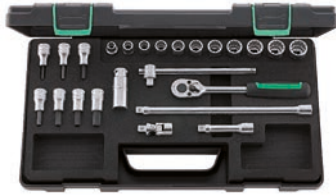

Code	Δ g
9602 1223	2633

456/49/19/5 Socket set 3/8" □

in sturdy, stackable ABS plastic case,
24 pieces

Content:

- 11 sockets with hexagon No 456:
sizes 8; 10; 11; 12; 13; 14; 15;
16; 17; 18; 19 mm
- 1 socket with bi-hexagon, long,
with rubber insert No 4600:
size 16 mm - 5/8"
- 7 INHEX sockets No 49: sizes 3; 4; 5; 6; 7; 8; 10 mm
- 1 ratchet No 435
- 2 extensions No 427/3 (76 mm), No 427/10 (240 mm)
- 1 T-handle No 425
- 1 universal joint No 428

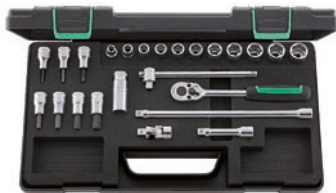

Code	Δ g
9602 1236	2707

40/45/36/12 Socket set 1/4; 3/8" □

in sturdy, stackable ABS plastic case,
48 pieces

Content:

- 8 sockets with hexagon No 40:
sizes 4; 4.5; 5; 5.5; 6; 7; 8; 9 mm
- 12 sockets with bi-hexagon No 45:
sizes 10; 11; 12; 13; 14; 15; 16;
17; 18; 19; 21; 22 mm
- 1 socket with bi-hexagon, long,
with rubber insert No 4600:
size 16 mm - 5/8"
- 3 bits ⊕ 1221: size 1; 1222: size 2; 1223: size 3
- 1 bit ⊕ PZ1222: size 2
- 6 bits ⊖ 1160: 0.5 x 3 mm; 1162: 0.6 x 3.5 mm; 1164: 0.8 x 4 mm;
1166: 1.0 x 5.5 mm; 1166/1: 1.2 x 6.5 mm; 1168: 1.6 x 8 mm
- 5 bits ● 1300: 3 mm; 1301: 4 mm; 1302: 5 mm; 1303: 6 mm;
1304: 8 mm
- 2 ratchets No 415, No 435
- 3 extensions No 427/3 (76 mm), No 405/6 (150 mm),
No 427/10 (240 mm)
- 2 universal joints No 407, No 428
- 1 drive handle No 400
- 1 T-handle No 425
- 2 bit-holder No 412, No 442
- 1 adaptor No 431

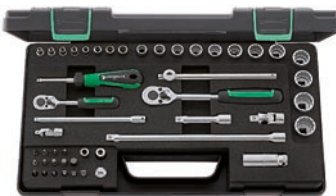

Code	Δ g
9601 2047	2963

89 Socket set 3/8" □

in sturdy, stackable ABS plastic case,
44 pieces

Content:

- 15 sockets with bi-hexagon No 45:
sizes 7; 8; 9; 10; 11; 12; 13; 14;
15; 16; 17; 18; 19; 21; 22 mm
- 2 sockets with bi-hexagon, long,
with rubber insert,
No 4600: size 16 mm - 5/8",
No 46: size 20.8 mm - 13/16"
- 7 INHEX sockets No 49:
sizes 3; 4; 5; 6; 7; 8; 10 mm
- 15 combination spanners No 13:
sizes 7; 8; 9; 10; 11; 12; 13; 14; 15; 16; 17; 18; 19; 21; 22 mm
- 1 ratchet No 435
- 2 extensions No 427/3 (76 mm), No 427/10 (240 mm)
- 1 T-handle No 425
- 1 universal joint No 428



Code	Δ g
9602 3128	5019

45/41/9 Socket set 3/8" □

in sturdy sheet steel case,
50 pieces

Content:

- 11 sockets with bi-hexagon No 45:
sizes 8; 10; 11; 12; 13; 14; 15;
16; 17; 18; 19 mm
- 9 sockets with bi-hexagon, long,
No 46: sizes 10; 11; 12; 13; 14;
15; 17; 18; 19 mm
- 2 sockets with bi-hexagon, long, with rubber insert
No 4600: size 16 mm - 5/8"; No 46: size 20.8 mm - 13/16"
- 10 UNIFLEX sockets with bi-hexagon No 47:
sizes 10; 11; 12; 13; 14; 15; 16; 17; 18; 19 mm
- 5 INHEX sockets No 49: size 4; 5; 6; 8; 10 mm
- 4 bits ⊕ 1231: size 1; 1232: size 2; 1233: size 3; 1234: size 4
- 1 ratchet No 435
- 2 extensions No 427/3 (76 mm), No 427/10 (240 mm)
- 1 flexible handle No 424
- 1 T-handle No 425
- 1 universal joint No 428
- 1 flexible extension No 434
- 1 bit-holder No 443



Code	Δ g
9602 0108	6521

45ma/28/5 Socket set 3/8" □

in sturdy, stackable ABS plastic case,
33 pieces

Content:

- 28 sockets with bi-hexagon
No 45: sizes 7; 8; 9; 10; 11; 12;
13; 14; 15; 16; 17; 18;
19; 20; 21; 22 mm
- No 45a: sizes 1/4; 5/16; 11/32; 3/8;
7/16; 1/2; 9/16; 5/8; 11/16; 3/4;
13/16; 7/8"
- 1 ratchet No 435
- 2 extensions No 427/3 (76 mm), No 427/10 (240 mm)
- 1 T-handle No 425
- 1 universal joint No 428



Code	Δ g
9602 1122	2898

Sockets, Socket Sets

10
3/8"

DIN
3120

ISO
1174-1

45ma/28/5QR Socket set 3/8"

NEW

QR

in sturdy, stackable ABS plastic case,
33 pieces

Content:

28 sockets with bi-hexagon

No 45: sizes 7; 8; 9; 10; 11; 12;
13; 14; 15; 16; 17; 18;
19; 20; 21; 22 mm

No 45a: sizes 1/4; 5/16; 11/32; 3/8; 7/16; 1/2; 9/16; 5/8; 11/16; 3/4; 13/16; 7/8"

1 ratchet No 435QR N

2 extensions No 427QR/3 (76 mm), No 427QR/10 (240 mm)

1 T-handle No 425QR

1 universal joint No 428QR



Code	△△ g
96020107	2898

45TX/49TX/15/5 Socket set TORX® 3/8"

in sturdy, stackable ABS plastic case,
20 pieces

Content:

7 sockets for external TORX®

screws No 45TX:

sizes E5; E6; E7; E8; E10;
E12; E14

8 screwdriver sockets for internal

TORX® screws No 49TX:

sizes T9; T10; T15; T20; T25; T27; T30; T40

1 ratchet No 435

2 extensions No 427/5 (125 mm), No 427/10 (240 mm)

1 universal joint No 428

1 T-handle No 425

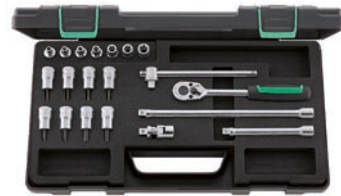

Code	△△ g
96023703	1963

89TX Socket set TORX® 1/4; 3/8; 1/2"

in sturdy, stackable ABS plastic case,
35 pieces

Content:

3 sockets for external TORX® screws

No 40TX: sizes E4; E5; E6

2 screwdriver sockets for internal

TORX® screws No 44KTX:

sizes T8; T9

4 sockets for external TORX® screws No 45TX:

sizes E7; E8; E10; E12

5 screwdriver sockets for internal TORX® screws No 49TX:

sizes T10; T15; T20; T25; T27

6 sockets for external TORX® screws No 50TX:

sizes E11; E14; E16; E18; E20; E24

6 screwdriver sockets for internal TORX® screws No 54TX:

sizes T30; T40; T45; T50; T55; T60

7 bits 1440: T10; 1441: T15; 1442: T20; 1443: T25; 1444: T27;

1445: T30; 1446: T40

1 bit-holder No 442

1 TORX® controller: sizes E6; E7; E8; E10; E12; E14; E16; T10; T15; T20;
T25; T27; T30; T40; T45; T47; T50; T55; T60

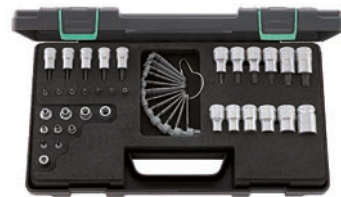

Code	△△ g
98811908	2568

45/49/32/5TX Socket set 3/8"

in sturdy, stackable ABS plastic case,
37 pieces

Content:

11 sockets with bi-hexagon No 45:

sizes 8; 10; 11; 12; 13; 14; 15;
16; 17; 18; 19 mm

7 sockets for external TORX®

screws No 45TX:

sizes E5; E6; E7; E8; E10; E12; E14

6 INHEX sockets No 49: sizes 4; 5; 6; 7; 8; 10 mm

8 screwdriver sockets for internal TORX® screws No 49TX:

sizes T9; T10; T15; T20; T25; T27; T30; T40

1 ratchet No 435

2 extensions No 427/3 (76 mm), No 427/10 (240 mm)

1 T-handle No 425

1 universal joint No 428

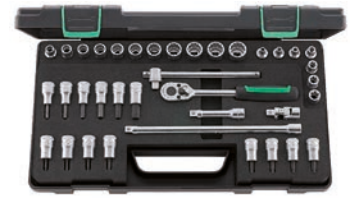

Code	△△ g
96022119	3078

45a/12/5 Socket set 3/8"

in sturdy, stackable ABS plastic case,
17 pieces

Content:

11 sockets with bi-hexagon No 45a:

sizes 1/4; 5/16; 11/32; 3/8; 7/16; 1/2;
9/16; 5/8; 11/16; 3/4; 13/16"

1 socket with bi-hexagon, long,

with rubber insert No 4600:

size 16 mm - 5/8"

1 ratchet No 435

2 extensions No 427/3 (76 mm), No 427/10 (240 mm)

1 T-handle No 425

1 universal joint No 428



Code	△△ g
96025204	1746

45a/33/13 Socket set 3/8"

in sturdy sheet steel case,
46 pieces

Content:

10 sockets with bi-hexagon No 45a:

sizes 1/4; 5/16; 11/32; 3/8; 7/16; 1/2;
9/16; 5/8; 11/16; 3/4"

2 sockets with bi-hexagon, long,

with rubber insert,

No 4600: size 16 mm - 5/8"

No 46: size 20.8 mm - 13/16"

7 sockets with bi-hexagon, long,

No 46a: sizes 3/8; 7/16; 1/2; 9/16; 11/16; 3/4; 7/8"

7 UNIFLEX sockets with bi-hexagon No 47a:

sizes 3/8; 7/16; 1/2; 9/16; 5/8; 11/16; 3/4"

3 INHEX sockets No 49a: sizes 1/8; 5/32; 3/16"

4 bits 1231: size 1; 1232: size 2; 1233: size 3; 1234: size 4

2 ratchets No 415, No 435

1 ratchet adaptor No 445

3 extensions No 427/3 (76 mm), No 427/6 (160 mm),
No 427/10 (240 mm)

1 flexible extension No 434 (194 mm)

1 adaptor No 409

1 speeder brace No 421

1 flexible handle No 424

1 T-handle No 425

1 universal joint No 428

1 bit-holder No 443

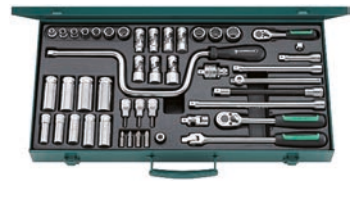

Code	△△ g
96024113	6540

45a/14/8QR Socket set 3/8"



in sturdy, stackable ABS plastic case, 22 pieces

Content:

- 14 sockets with bi-hexagon No 45a: sizes 1/4; 5/16; 11/32; 3/8; 7/16; 1/2; 9/16; 5/8; 11/16; 3/4; 13/16; 7/8; 15/16; 1"
- 1 ratchet No 435SG-QR
- 3 extensions No 427/3QR (76 mm), No 427/6QR (160 mm), No 427/10QR (240 mm)
- 1 universal joint No 428QR
- 2 bit-holders No 442, No 443
- 1 speeder brace No 453



Code	ΔΔ g
96 02 52 06	3507

45a/22/8QR Socket set 3/8"



in sturdy, stackable ABS plastic case, 30 pieces

Content:

- 14 sockets with bi-hexagon No 45a: sizes 1/4; 5/16; 11/32; 3/8; 7/16; 1/2; 9/16; 5/8; 11/16; 3/4; 13/16; 7/8; 15/16; 1"
- 8 UNIFLEX sockets with bi-hexagon No 47a: sizes 5/16; 3/8; 7/16; 1/2; 9/16; 5/8; 11/16; 3/4"
- 1 ratchet No 435SG-QR
- 3 extensions No 427/3QR (76 mm), No 427/6QR (160 mm), No 427/10QR (240 mm)
- 1 universal joint No 428QR
- 2 bit-holders No 442, No 443
- 1 speeder brace No 453



Code	ΔΔ g
96 02 52 07	3970

ES 456/16/6

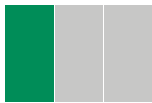

175 x 350 x 40 mm, 22 pieces



Code	ΔΔ g
96 83 81 11	1555

	No 456	3/8" ○ sizes 7; 8; 9; 10; 11; 12; 13; 14; 15; 16; 17; 18; 19; 20; 21; 22 mm
	No 425	3/8" ■ 165 mm
	No 427/3	3/8" ■ ○ 76 mm
	No 427/6	3/8" ■ ○ 160 mm
	No 427/10	3/8" ■ ○ 240 mm
	No 428	3/8" ■ ○ 46 mm
	No 435	3/8" ■

83 81 20 32	Empty tray	103
--------------------	------------	-----

TCS 456/16/6

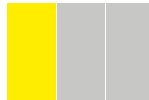

175 x 350 x 45 mm, 22 pieces



Code	ΔΔ g
96 83 87 52	1465

	No 456	3/8" ○ sizes 7; 8; 9; 10; 11; 12; 13; 14; 15; 16; 17; 18; 19; 20; 21; 22 mm
	No 425	3/8" ■ 165 mm
	No 427/3	3/8" ■ ○ 76 mm
	No 427/6	3/8" ■ ○ 160 mm
	No 427/10	3/8" ■ ○ 240 mm
	No 428	3/8" ■ ○ 46 mm
	No 435	3/8" ■

TCS 456/16/7

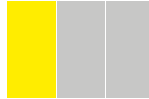

175 x 350 x 40 mm, 23 pieces



Code	ΔΔ g
96 83 02 18	1400

	No 456	3/8" ○ sizes 7; 8; 9; 10; 11; 12; 13; 14; 15; 16; 17; 18; 19; 20; 21; 22 mm
	No 427/3	3/8" ■ ○ 76 mm
	No 427/5	3/8" ■ ○ 125 mm
	No 427/10	3/8" ■ ○ 240 mm
	No 428	3/8" ■ ○ 46 mm
	No 431	1/4" ■ 3/8" ○
	No 432	1/2" ■ 3/8" ○
	No 435	3/8" ■

TCS 456/16/4 MF

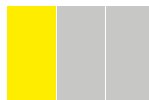

175 x 350 x 45 mm, 20 pieces



Code	ΔΔ g
96 83 03 57	1123

	No 456	3/8" ○ sizes 7; 8; 9; 10; 11; 12; 13; 14; 15; 16; 17; 18; 19; 20; 21; 22 mm
	No 427/5	3/8" ■ ○ 125 mm
	No 427/10	3/8" ■ ○ 240 mm
	No 428	3/8" ■ ○ 46 mm
	No 435	3/8" ■

Sockets, Socket Sets

10
3/8"

DIN
3120

ISO
1174-1













TCS 456/31/8



TCS



350 x 350 x 32 mm, 39 pieces

Code		Δ g
96 83 06 02		2701
 No 456	3/8" \bigcirc sizes 7; 8; 9; 10; 11; 12; 13; 14; 15; 16; 17; 18; 19; 20; 21; 22 mm	
 No 46	3/8" \bigcirc sizes 10; 11; 12; 13 mm	
 No 47	3/8" \bigcirc sizes 10; 11; 12; 13; 14; 15; 16 mm	
 No 1049	3/8" \bigcirc size 9 mm	
 No 49X	3/8" \bigcirc sizes M6; M8; M10	
 No 427/3	3/8" \blacksquare \bigcirc 76 mm	
 No 427/5	3/8" \blacksquare \bigcirc 125 mm	
 No 427/10	3/8" \blacksquare \bigcirc 240 mm	
 No 428	3/8" \blacksquare \bigcirc 46 mm	
 No 431	1/4" \blacksquare 3/8" \bigcirc	
 No 432	1/2" \blacksquare 3/8" \bigcirc	
 No 435	3/8" \blacksquare	
 No 452	3/8" \blacksquare	



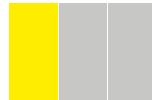

TCS 49/1049/2049/45TX/49TX



TCS



175 x 350 x 40 mm, 24 pieces

Code		Δ g
96 83 87 72		1188
 No 49	3/8" \bigcirc sizes 4; 5; 6; 7; 8; 10 mm	
 No 1049 No 2049	3/8" \bigcirc size 7 mm 3/8" \bigcirc sizes 4; 5; 6; 8; 10 mm	
 No 45TX	3/8" \bigcirc sizes E5; E6; E7; E8; E10; E12	
 No 49TX	3/8" \bigcirc sizes T10; T15; T20; T25; T30; T40	

3

STAHLWILLE »AS-Drive«



STAHLWILLE sockets are equipped with the AS-Drive* profile: this permits high transmission of forces to the lands of nuts and bolts without damaging them. No longer will you have to worry about stripping the corners off nuts and bolts.

*Anti-Slip-Drive

STAHLWILLE HPQ® sockets



STAHLWILLE HPQ® sockets are manufactured from selected tough steel alloys. The result: they are extremely durable. HPQ® sockets are free of cadmium and are therefore suitable for use on titanium alloy parts and titanium fasteners as used e.g. in the aerospace industry, where safety is a crucial factor.

*High Performance Quality

Tool Control System The safety inlay system

- Designed to fit our Tool Trolleys and Tool Boxes
- With yellow signal cut-outs to show whether all tools are in their places

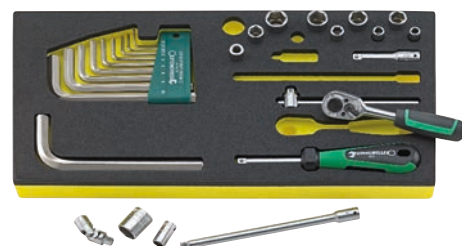

50 Sockets



metric sizes: DIN 3124/ISO 2725-1, E DIN EN 3709, ASME B 107.5 M,
 American sizes: ASME B 107.1, Fed. Spec. GGG-W-641,
 SAE AS 954-E (test loads), HPQ® high performance steel, chrome plated.

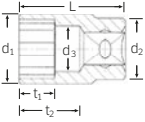

Code	Ø	d ₁	d ₂	d ₃	L	t ₁	t ₂	⚖	📦
	mm	mm	mm	mm	mm	mm	mm	g	
03010008	8	13	22	7	38	9	22	56	10
03010009	9	13.7	22	8	38	9	22	57	10
03010010	10	14.5	22	9	38	9	22	57	10
03010011	11	15.8	22	10	38	9.5	22	52	10
03010012	12	17	22	11	38	13	22	58	10
03010013	13	18.3	22	12	38	13	22	60	10
03010014	14	19.9	22.7	13	38	13	20.5	60	10
03010015	15	21.2	22.7	14	38	13.5	20.2	62	10
03010016	16	22.4	23.7	15	38	13.5	19.6	63	10
03010017	17	24	23.7	15.2	38	15	19.6	66	10
03010018	18	24.7	23.7	17	38	15.5	19.1	71	10
03010019	19	26.2	25	18	38	16	21.7	78	10
03010020	20	27.2	25	19	42	15	25.5	89	10
03010021	21	28.7	26	20	42	16	25.2	104	10
03010022	22	29.7	26	21	42	16.5	24.9	113	10
03010023	23	30.7	26	20	42	18	25.4	114	5
03010024	24	32	26	21	42	18.5	24.9	117	5
03010025	25	33.2	25	22	42	18.5	24.6	119	5
03010026	26	34.4	25	23	42	18.5	24.3	122	5
03010027	27	36.2	26	24	45	19.5	27	150	5
03010028	28	37.4	27	25	45	19.5	26.7	158	5
03010030	30	39.7	28	27	45	20.5	26.1	171	5
03010031	31	42.2	28	28	47	22	27.9	215	5
03010032	32	42.2	28	29	47	22	27.6	189	5
03010034	34	45	28	31	47	22	27	209	5
03010036 NEW	36	48	31	34	52	24	30.9	291	5

50a Sockets

Code	Ø	d ₁	d ₂	d ₃	L	t ₁	t ₂	⚖	📦
	"	mm	mm	mm	mm	mm	mm	g	
03410024	3/8	14.3	22	8.3	38	9	22	57	10
03410028	7/16	16.3	22	9.9	38	9	22	59	10
03410032	1/2	18.3	22	11.5	38	13	22	59	10
03410034	9/16	20.3	22.7	13.1	38	13	20.2	62	10
03410035	19/32	21.3	22.7	13.5	38	13.5	20.1	61	10
03410036	5/8	22.4	23.7	15	38	13.5	19.6	62	10
03410038	11/16	24.2	23.7	16.5	38	15.5	19.2	68	10
03410040	3/4	26.2	25	18	38	16	21.7	78	10
03410041	25/32	27	25	18.6	41	16	24.6	90	5
03410042	13/16	28.2	25	19.4	41	16.5	24.3	95	5
03410044	7/8	29.7	26	21	42	18	24.9	111	5
03410046	15/16	32	26	22.6	42	18.5	24.4	121	5
03410048	1	33.7	27	24.2	42	18.5	24	135	5
03410050	1 1/16	36.2	26	25.8	45	19.5	26.5	155	5
03410052	1 1/8	38.1	28	27.4	45	20	26	167	5
03410054	1 3/16	39	28	28	45	20.5	25.9	178	5
03410056	1 1/4	40	28	30.5	45	21	25.1	196	5
03410058	1 5/16	41.8	28	32.1	47	22	26.7	170	5
03410060	1 3/8	46	28	33.7	50	23	29.2	232	5
03410062	1 7/16	49.4	31	34	54	26	33.1	320	5
03410064	1 1/2	51	31	35	54	26	32.8	330	5

52 Sockets



DIN 3124/ISO 2725-1, ASME B 107.5M, E DIN EN 3709 (test loads),
 HPQ® high performance steel, chrome plated.

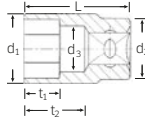

Code	Ø	d ₁	d ₂	d ₃	L	t ₁	t ₂	⚖	📦
	mm	mm	mm	mm	mm	mm	mm	g	
03030008	8	13	22	7	38	9	22	56	10
03030009	9	13.7	22	8	38	9	22	56	10
03030010	10	14.5	22	9	38	9	22	60	10
03030011	11	15.8	22	10	38	9.5	22	58	10
03030012	12	17	22	11	38	13	22	52	10
03030013	13	18.3	22	12	38	13	22	51	10
03030014	14	19.9	22.7	13	38	13	20.5	59	10
03030015	15	21.2	22.7	14	38	13.5	20.2	63	10
03030016	16	22.4	23.7	15	38	13.5	19.6	65	10
03030017	17	24	23.7	15.2	38	15	19.6	70	10
03030018	18	24.7	23.7	17	38	15.5	19.1	73	10
03030019	19	26.2	25	18	38	16	21.7	80	10
03030020	20	27.2	25	19	42	15	25.5	95	10
03030021	21	28.7	26	20	42	16	25.2	110	10
03030022	22	29.7	26	21	42	16.5	24.9	115	10
03030023	23	30.7	26	20	42	18	25.4	119	5
03030024	24	32	26	21	42	18.5	24.9	125	5
03030025	25	33.2	26	22	42	18.5	24.6	128	5
03030026	26	34.4	25	23	42	18.5	24.3	132	5
03030027	27	36.2	26	24	45	19.5	27	161	5
03030028	28	37.4	27	25	45	19.5	26.7	166	5
03030030	30	39.7	28	27	45	20.5	26.1	186	5
03030032	32	42.2	28	29	47	22	27.6	200	5
03030034	34	45	28	31	47	22	27	235	5
03030036 NEW	36	48	31	34	52	24	30.9	305	5

ES 52/17



175 x 350 x 47 mm, 17 pieces

Code	⚖
	g
96838112	1760

No 52	1/2" Ø sizes 10; 11; 12; 13; 14; 15; 16; 17; 18; 19; 20; 21; 22; 24; 27; 30; 32 mm
--------------	--

83812030 Empty tray	107
----------------------------	-----

12.5
1/2"

DIN
3120

ISO
1174-1

3

Sockets, Socket Sets

12.5
1/2"

DIN
3120

ISO
1174-1

TCS 52/17

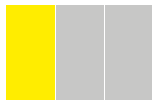

TCS

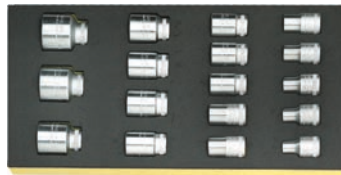

175 x 350 x 40 mm, 17 pieces

Code	Δ g
96838177	1605

	No 52	1/2" \varnothing sizes 10; 11; 12; 13; 14; 15; 16; 17; 18; 19; 20; 21; 22; 24; 27; 30; 32 mm
--	--------------	--

3

TCS 52/18 MF



TCS



175 x 350 x 55 mm, 18 pieces

Code	Δ g
96830359	1850

	No 52	1/2" \varnothing sizes 10; 11; 12; 13; 14; 15; 16; 17; 18; 19; 20; 21; 22; 24; 27; 30; 32; 34 mm
--	--------------	--

TCS 50/51/52/32

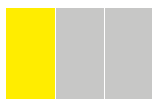

TCS



175 x 350 x 50 mm, 32 pieces

Code	Δ g
96838191	2950

	No 50	1/2" \varnothing sizes 8; 9; 10; 11; 12; 13; 14; 15; 16; 17; 18; 19; 30 mm
--	--------------	--

	No 52	1/2" \varnothing sizes 10; 11; 12; 13; 14; 15; 16; 17; 18; 19; 20; 21; 22; 24; 27; 30; 32 mm
--	--------------	--

	No 51	1/2" \varnothing sizes 22; 27 mm
--	--------------	------------------------------------

TCS 50a/17

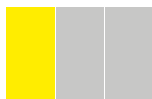

TCS



175 x 350 x 40 mm, 17 pieces

Code	Δ g
96838780	1600

	No 50a	1/2" \varnothing sizes 3/8; 7/16; 1/2; 9/16; 19/32; 5/8; 11/16; 3/4; 25/32; 13/16; 7/8; 15/16; 1; 1 1/16; 1 1/8; 1 3/16; 1 1/4"
--	---------------	---

51

○ Sockets

AS
DRIVE

HPQ

extra deep, metric sizes: DIN 3124/ISO 2725-1, E DIN EN 3710, E DIN EN 3709, ASME B 107.5M, American sizes: ASME B 107.1, Fed. Spec. GGG-W-641, SAE AS 954-E, HPQ® high performance steel, chrome plated.

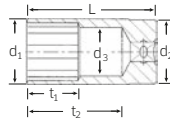

Code	\varnothing mm/"	d ₁ mm	d ₂ mm	d ₃ mm	L mm	t ₁ mm	t ₂ mm	Δ g	
03020010	10	14.5	22	9	83	19	67	90	10
03020013	13	18.3	22	12	83	35	67	122	10
03020014	14	19.9	22.7	13	83	35	65.2	129	10
03020015	15	21.2	22.7	14	83	35	64.9	132	10
03020016	16	22.4	23.7	15	83	35	64.6	145	10
03020016	16-⁵/₈ ¹⁾	22.4	23.7	15.4	83	19	64.5	137	10
03020017	17	24	23.7	16	83	35	64.3	132	10
03020018	18	24.7	23.7	17	83	35	64.1	170	10
03020019	19	26.2	25	18	83	35	66.7	186	10
03020019	19	26.2	25	18	83	35	66.7	186	10
03020020	20	27.7	26	20	83	22	66.2	194	10
03020021	21	28.7	26.5	20	83	35	66.2	231	10
03020022	22	29.7	27.5	21	83	35	65.5	200	10
03020024	24	32	30	21	83	35	66.1	280	5
03020026	26	34.4	32.5	23	83	35	65.3	334	5
03020027	27 ²⁾	36.2	34	27	83	20	60	294	5
03020030	30 ²⁾	39.7	37.5	30.2	83	35	65	341	5
03020032	32	42.4	40	29	83	35	63.9	461	5

¹⁾ with rubber insert for spark plugs

²⁾ for diesel injector (Audi, Daihatsu, Ford, Mazda, Mercedes, Mitsubishi, Nissan, Opel, Peugeot, Toyota, VW, Volvo)

51a

○ Sockets

Code	\varnothing "	d ₁ mm	d ₂ mm	d ₃ mm	L mm	t ₁ mm	t ₂ mm	Δ g	
03420024	3/8	14.3	22	8.3	83	19	67	93	5
03420028	7/16	16.3	22	9.9	83	19	67	102	5
03420032	1/2	18.3	22	11.5	83	35	67	122	5
03420034	9/16	20.3	22.7	13.1	83	35	65.2	131	5
03420036	5/8	22.4	23.7	15	83	35	64.6	145	5
03420038	11/16	24.2	23.7	16.5	83	35	64.2	158	5
03420040	3/4	26.2	25	18	83	35	66.7	188	5
03420042	13/16	27.7	26	19.5	83	35	66.3	170	5
03420044	7/8	29.7	27.5	21	83	35	65.9	200	5
03420046	15/16	32	30	22.6	83	35	65.7	281	5
03420048	1	33.7	32	24.2	83	35	65	260	5
03420050	1 1/16	36.2	34	25.8	83	35	64.5	359	5
03420052	1 1/8	38.1	36	27.4	83	35	64	300	5
03420054	1 3/16	39	37	28	83	35	63.9	377	5
03420056	1 1/4	40	38	30.5	83	35	63.1	433	5
03420058	1 5/16	41.8	40	32.1	83	35	62.7	479	5
03420060	1 3/8	46	44	33.7	83	35	62.2	506	5
03420062	1 7/16	49.4	47	34	83	35	62.1	635	5
03420064	1 1/2	51	49	35	83	35	61.8	675	5

5100

Rubber insert

for size 20.8 mm (No 51; 51S; 46).

Code	Δ g	
09010001	6	5

51/8 Set: Sockets



long.
Content:
13; 17; 19; 22; 24; 27; 30; 32 mm



Code	g	
96 03 02 12	2780	1

in softcase with foam inlay

TCS 51/11

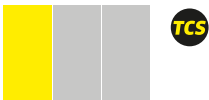

175 x 350 x 50 mm, 11 pieces



Code	g
96 83 87 76	2345

No 51 sizes 10; 13; 15; 17; 18; 19; 22; 24; 27; 30; 32 mm

51S Sockets



extra deep, DIN 3124/ISO 2725-1, E DIN EN 3710, E DIN EN 3709 (test loads), HPQ® high performance steel, chrome plated.

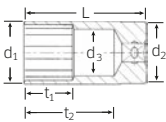

Code	mm/"	d ₁ mm	d ₂ mm	d ₃ mm	L mm	t ₁ mm	t ₂ mm	g	
03 24 00 17	17	24	23.7	16	83	35	64.3	157	10
03 24 00 19	19	26.2	25	18	83	35	66.7	190	10
03 24 02 08	20.8-13/16¹⁾	27.7	26	20	83	22	66.2	196	10
03 24 00 22	22	29.7	27.5	21	83	35	65.9	246	10

¹⁾ with rubber insert for spark plugs and for tightening and untightening wheel nuts on Japanese cars

53 UNIFLEX sockets



Chrome Alloy Steel, chrome plated.

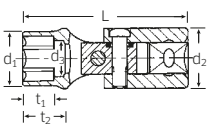

Code	mm	d ₁ mm	d ₂ mm	d ₃ mm	L mm	t ₁ mm	t ₂ mm	g	
03 04 00 10	10	14.7	25	9	70	12	20	136	1
03 04 00 13	13	18.4	25	12	70	12	20	140	1
03 04 00 16	16	22.4	25	15	69	13	17	141	1
03 04 00 17	17	23.5	25	16	70	13	18	141	1
03 04 00 18	18	25	25	17	70	12	18	145	1
03 04 00 19	19	26.3	25	18	70	12	17.5	148	1

50TX Sockets



for external TORX® screws, HPQ® high performance steel, chrome plated.

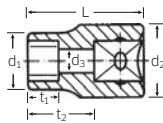

Code	size	d ₁ mm	d ₂ mm	d ₃ mm	L mm	t ₁ mm	t ₂ mm	g		
03 27 00 10	E10	9.4	13	22	5.6	38	9.5	22	53	10
03 27 00 11	E11	10.1	14	22	6	38	9.5	22	50	10
03 27 00 12	E12	11.1	14.9	22	7.2	38	9.5	22	55	10
03 27 00 14	E14	12.9	16.7	22	8	38	11	22	56	10
03 27 00 16	E16	14.7	19	22	9.3	38	12.5	22	60	10
03 27 00 18	E18	16.6	21	26.5	10.4	38	13.5	22	92	10
03 27 00 20	E20	18.4	23.5	26.5	12	38	15	22	98	10
03 27 00 24	E24	22.1	27.8	26	14.1	41.2	17.5	23.6	123	10

50TX/7 Set: Sockets



for external TORX® screws.
Content: E10; E12; E14; E16; E18; E20; E24



Code	g	
96 03 27 03	623	1

packed in carton

50TX/8 Set: Sockets



for external TORX® screws.
Content:
E10; E11; E12; E14; E16; E18; E20; E24



Code	g	
96 03 37 04	1052	1

in sturdy, stackable ABS plastic case

12.5
1/2"

DIN
3120

ISO
1174-1

3

Sockets, Socket Sets

12.5
1/2"

DIN
3120

ISO
1174-1

TCS 50TX/54TX/17



175 x 350 x 40 mm, 17 pieces

Code		Δ g
96 83 87 63		1382
No 50TX	1/2" \circ sizes E10; E11; E12; E14; E16; E18; E20; E24	
No 54TX	1/2" \circ sizes T20; T25; T27; T30; T40; T45; T50; T55; T60	

50aPSP Sockets spline-drive



MS-33787, HPQ® high performance steel, gunmetal finish.

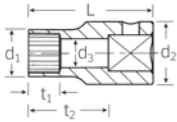

Code	Spline size	\circ "	d ₁ mm	d ₂ mm	d ₃ mm	L mm	t ₁ mm	t ₂ mm	Δ g	
03 01 20 24	12	3/8	15.5	22	8.6	38	9.5	22	55	5
03 01 20 28	14	7/16	18	23.7	10.4	38	11	22	65	5
03 01 20 34	18	9/16	22	23.7	13.5	38	12	20	71	5

50aPLSP Socket spline-drive



extra deep bolt clearance, MS-33787, HPQ® high performance steel, gunmetal finish.

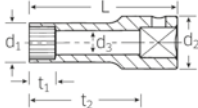

Code	Spline size	\circ "	d ₁ mm	d ₂ mm	d ₃ mm	L mm	t ₁ mm	t ₂ mm	Δ g	
03 01 30 28	14	7/16	18	23.7	10.4	50	11	34	83	5

51aP Socket



extra deep bolt clearance, HPQ® high performance steel, gunmetal finish. For the brakes on A320/A321.

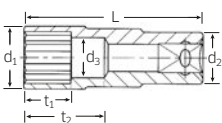

Code	\circ "	d ₁ mm	d ₂ mm	d ₃ mm	L mm	t ₁ mm	t ₂ mm	Δ g	
03 42 10 41	25/32	28	23	17.9	80	21	36	182	1

54 INHEX sockets

for hexagon socket head screws, DIN 7422, Chrome Alloy Steel, chrome plated.

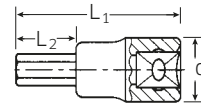

Code	\circ mm	L ₁ mm	L ₂ mm	d mm	Δ g	
03 05 00 04	4	60	22	22.7	68	5
03 05 00 05	5	60	22	22.7	68	5
03 05 00 06	6	60	22	22.7	71	5
03 05 00 07	7	60	22	22.7	75	5
03 05 00 08	8	60	22	22.7	79	5
03 05 00 10	10	60	22	22.7	97	5
03 05 00 12	12	60	20	23.7	122	5
03 05 00 14	14	60	20	23.7	135	5
03 05 00 17	17	60	20	27.5	186	5
03 05 00 19	19	60	20	31	242	5

54a INHEX sockets

Code	\circ "	L ₁ mm	L ₂ mm	d mm	Δ g	
03 45 00 14	7/32	60	22	22.7	70	5
03 45 00 16	1/4	60	22	22.7	75	5
03 45 00 20	5/16	60	22	22.7	81	5
03 45 00 24	3/8	60	22	22.7	97	5
03 45 00 28	7/16	60	22	22.7	103	5
03 45 00 32	1/2	60	20	23.7	125	5
03 45 00 34	9/16	60	20	23.7	137	5
03 45 00 36	5/8	60	20	27.5	169	5
03 45 00 40	3/4	60	20	31	244	2

54/10 INHEX socket set No 54

sizes 4; 5; 6; 7; 8; 10; 12; 14; 17; 19 mm



Code	Δ g
96 03 15 08	1552

in sturdy, stackable ABS plastic case

54/12 INHEX socket set

Content:
12 INHEX sockets
No 54, sizes 4, 5, 6, 7, 8, 10, 12, 14, 17, 19 mm,
No 3054/8, No 1054/10



Code	Δ g	
96 03 15 03	1963	1

in sturdy, stackable ABS plastic case

ES 54/54KK

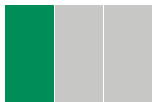

175 x 350 x 38 mm, 14 pieces

Code			Δ	∇	g
96838114			1630		
No 54	1/2" \odot sizes 4; 5; 6; 7; 8; 10; 12; 14; 17; 19 mm				
No 54KK	1/2" \odot sizes 5; 6; 8; 10 mm				
83812046	Empty tray		108		

TCS 54/54X/16

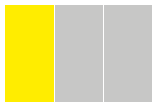

TCS



175 x 350 x 35 mm, 16 pieces

Code			Δ	∇	g
96838762			1665		
No 54	1/2" \odot sizes 4; 5; 6; 7; 8; 10; 12; 14; 17 mm				
No 54X	1/2" \odot sizes M5; M6; M8; M10; M12; M14; M16				

1054/2054 INHEX sockets

for hexagon socket head screws, extra long, DIN 7422, Chrome Alloy Steel, chrome plated.



Code	No	\odot mm	L ₁ mm	L ₂ mm	d mm	Δ	∇	g	
03151205	2054/5	5	120	82	22.7	78		5	
03151206	2054/6	6	120	82	22.7	84		5	
03151207	2054/7	7	120	82	22.7	96		5	
03151208	1054/8K	8	120	82	22.7	104		5	
03151410	1054/10	10	140	102	22.7	150		5	
03151412	1054/12¹⁾	12	140	100	23.7	197		5	
03151414	2054/14	14	140	100	23.7	231		5	

¹⁾ For fitting radiators

1054/3054 INHEX sockets

for hexagon socket head screws, special lengths, DIN 7422, Chrome Alloy Steel, chrome plated.



Code	No	\odot mm	L ₁ mm	L ₂ mm	d mm	Δ	∇	g	
03151805	1054/5	5	180	20	22	118		5	
03150706	1054/6	6	70	32	22.7	72		5	
03151006	3054/6¹⁾	6	100	62	22.7	80		5	
03152206	1054/6L	6	220	182	22.7	108		5	
03151007	1054/7	7	100	62	22.7	87		5	
03150808	3054/8	8	80	42	22.7	88		5	
03151408	1054/8	8	140	102	22.7	114		5	
03150713	1054/13	13	70	25	24	130		5	

¹⁾ for intake manifolds on 5-cylinder diesel engines on VW/Audi and T4 vans

ES 1054/2054

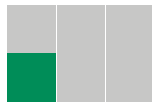

175 x 175 x 30 mm, 6 pieces

Code			Δ	∇	g
96838164			900		
No 1054	1/2" \odot sizes 8; 10; 12 mm				
No 2054	1/2" \odot sizes 5; 6; 14 mm				
83812081	Empty tray		55		

TCS 1054/2054/10



TCS

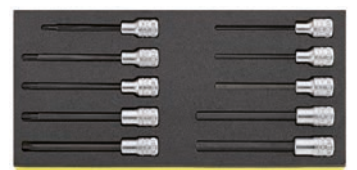

175 x 350 x 40 mm, 10 pieces

Code			Δ	∇	g
96838760			1272		
No 1054	1/2" \odot sizes 8; 10; 12 mm				
No 2054	1/2" \odot sizes 5; 6 mm				
No 1054TX	1/2" \odot sizes T30; T50; T55				
No 2054TX	1/2" \odot sizes T40; T45				

541C INHEX sockets

for hexagon socket head screws with guide pin, Chrome Alloy Steel, chrome plated.

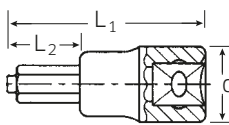

Code	\odot mm	L ₁ mm	L ₂ mm	d mm	Δ	∇	g	
03070005	5	60	22	22.7	70		5	
03070006	6	60	22	22.7	71		5	
03070008	8	60	22	22.7	70		5	
03070010	10	60	22	22.7	95		5	
03070012	12	60	20	23.7	120		5	
03070014	14	60	20	23.7	131		5	

54KK INHEX sockets

with ball point hexagon, for hexagon socket head screws, swivel angle up to 25° each side, Chrome Alloy Steel, chrome plated.

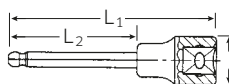

Code	\odot mm	L ₁ mm	L ₂ mm	d mm	Δ	∇	g	
03280005	5	100	62	22.7	75		5	
03280006	6	100	62	22.7	80		5	
03280007	7¹⁾	100	62	22.7	85		5	
03280008	8	100	62	22.7	95		5	
03280010	10	100	62	22.7	120		5	

¹⁾ Application: BMW brakes

12.5
1/2"

DIN
3120

ISO
1174-1

3

Sockets, Socket Sets

12.5
1/2"

DIN
3120

ISO
1174-1

ES 54KK/5



175 x 175 x 30 mm, 5 pieces

Code	g
96838165	505
83812051 No 54KK 1/2" O sizes 5; 6; 7; 8; 10 mm	
Empty tray	55

3

1054KK ● INHEX sockets

with ball point hexagon, for hexagon socket head screws, swivel angle up to 25° each side, special lengths, Chrome Alloy Steel, chrome plated.



Code	mm	L ₁ mm	L ₂ mm	d mm	g	g	g
03310005	5	238	200	22.7	145	5	
03310008	8	238	200	22.7	154	5	

54CV ● Screwdriver sockets

for spline socket head screws (Ribe-CV®), Chrome Alloy Steel, chrome plated.

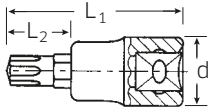

Code	size	L ₁ mm	L ₂ mm	d mm	g	g	g
03090005	M5	60	22	22.7	69	5	
03090006	M6	60	22	22.7	71	5	
03090007	M7	60	22	22.7	78	5	
03090008	M8	60	22	22.7	78	5	
03090009	M9	60	22	22.7	92	5	
03090010	M10	60	22	22.7	95	5	
03090012	M12	60	20	23.7	119	5	
03090013	M13	60	20	23.7	125	5	
03090014	M14	60	20	23.7	126	5	
03090016	M16	63	23	27.5	163	5	

Application:

Size M7, for brakes. cylinder head screws. bodywork and motor jobs incl. valve covers and spark plug covers on Fiat vehicles
 Size M8, bodywork and motor jobs incl. valve covers and spark plug covers on Fiat vehicles
 Size M9, brakes, cylinder head screws (1.2 l; 8V/16V) on Fiat vehicles
 Size M10, for cylinder head screws (1.2 l; 8V/16V) on Fiat vehicles
 Size M12 for cylinder head screws on Fiat 2.0 l engines
 Size M13, for brakes. cylinder head screws on Fiat vehicles; cylinder head screws on Alfa vehicles, e.g. 1.6 l; 16V engines
 Size M14; M16, for cylinder head screws on Alfa vehicles. e.g. 1.6 l; 16V engines

54CV/9 ● Set: Screwdriver sockets

for spline socket head screws (Ribe-CV®), 9 pieces, Content: M5; M6; M7; M8; M9; M10; M12; M13; M14



Code	g	g	g
96031901	1317	1	

in sturdy, stackable ABS plastic case

54X ● Screwdriver sockets

for trisquare socket head screws (XZN®), DIN 2324, Chrome Alloy Steel, chrome plated.

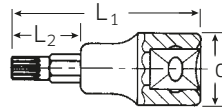

Code	size	L ₁ mm	L ₂ mm	d mm	g	g	g
03060005	M5	60	22	22.7	67	5	
03060006	M6	60	22	22.7	74	5	
03060008	M8	60	22	22.7	79	5	
03060010	M10	60	22	22.7	94	5	
03060012	M12	60	20	23.7	120	5	
03060014	M14	60	20	23.7	128	5	
03060016	M16	60	20	27.5	174	5	

3054X ● Screwdriver sockets

for trisquare socket head screws (XZN®), DIN 2324, extra long, Chrome Alloy Steel, chrome plated.

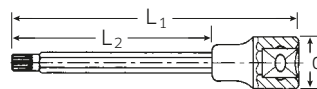

Code	size	L ₁ mm	L ₂ mm	d mm	g	g	g
03261408	M8	140	102	22.7	109	5	
03261410	M10	140	102	22.7	142	5	
03261412	M12	140	102	22.7	160	5	
03261414	M14	140	100	23.7	225	1	

Application: sizes M10 and M12 for cylinder head screws on VW/Audi, Opel, Mercedes-Benz, size M14 for cylinder head screws on VM diesel engines, Chrysler

3054X/54X/8 ● Set: Screwdriver sockets

for trisquare socket head screws (XZN®), 8 pieces, Content: 3054X: M8, M10, M12 54X: M6, M8, M10, M12, M14



Code	g	g	g
96033606	1357	1	

in sturdy, stackable ABS plastic case

1054x/2054x Screwdriver sockets

for trisquare socket head screws (XZN®), special lengths, DIN 2324, Chrome Alloy Steel, chrome plated.



Code	No	size	L ₁ mm	L ₂ mm	d mm	Δ g	
03 16 08 08	1054x	M8	80	42	22.7	86	5
03 16 12 08	2054x	M8	120	82	22.7	104	5
03 16 11 10	2054x	M10	110	72	22.7	130	5
03 16 11 12	2054x	M12	110	70	23.7	168	5

Application: No 1054x, size M8, for jointed shafts on VW/Audi

54TX Screwdriver sockets

for inside TORX® screws, Chrome Alloy Steel, chrome plated.

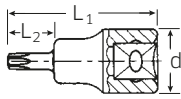

Code	size	mm	L ₁ mm	L ₂ mm	d mm	Δ g	
03 10 00 20	T20	3.8	55	17	22.7	71	5
03 10 00 25	T25	4.4	55	17	22.7	71	5
03 10 00 27	T27	5	55	17	22.7	72	5
03 10 00 30	T30	5.5	55	17	22.7	72	5
03 10 00 40	T40	6.6	55	17	22.7	72	5
03 10 00 45	T45	7.8	55	17	22.7	74	5
03 10 00 50	T50	8.8	55	17	22.7	87	5
03 10 00 55	T55	11.2	58	18	23.7	112	5
03 10 00 60	T60	13.2	58	18	23.7	113	5
03 10 00 70	T70	15.5	60	20	27.5	155	1

Application: size T55 for the cylinder head screws on the Opel Omega V6

54TX/9 Set: Screwdriver sockets

for inside TORX® screws, 9 pieces, Content: sizes T20; T25; T27; T30; T40; T45; T50; T55; T60



Code	Δ g	
96 03 10 04	820	1

packed in carton

54TX/10 Socket set TORX®

for inside TORX® screws, 10 pieces, Content: sizes T20; T25; T27; T30; T40 (2x); T45; T50; T55; T60



Code	Δ g
96 03 20 05	1197

in sturdy, stackable ABS plastic case

54TX/59TX/12/1 Socket set TORX®

for inside TORX® screws, 13 pieces, Content:

9 screwdriver sockets for internal TORX® screws No 54TX: sizes T20; T25; T27; T30; T40; T45; T50; T55; T60
3 screwdriver sockets for internal TORX® screws No 59TX: sizes T70; T80; T90
1 adaptor No 514, 1/2" socket x 3/4" plug (12.5 x 20)

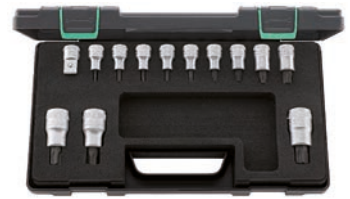

Code	Δ g
96 03 20 06	2595

in sturdy, stackable ABS plastic case

ES 54X/54TX



175 x 350 x 38 mm, 16 pieces

Code	Δ g
96 83 81 15	1600
No 54X	1/2" sizes M5; M6; M8; M10; M12; M14; M16
No 54TX	1/2" sizes T20; T25; T27; T30; T40; T45; T50; T55; T60
83 81 20 45	Empty tray 111

TCS 54/54TX/18

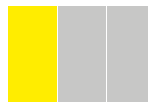

175 x 350 x 40 mm, 18 pieces

Code	Δ g
96 83 87 82	1665
No 54	1/2" sizes 4; 5; 6; 7; 8; 10; 12; 14; 17 mm
No 54TX	1/2" sizes T20; T25; T27; T30; T40; T45; T50; T55; T60

Made in Germany

12.5
1/2"

DIN
3120

ISO
1174-1

3

Sockets, Socket Sets

12.5
1/2"

DIN
3120

ISO
1174-1

1054TX/ 2054TX

Screwdriver sockets

for inside TORX® screws, extra long, Chrome Alloy Steel, chrome plated.



Code	No	size	mm	L ₁ mm	L ₂ mm	d mm	g	
03 13 12 30	1054TX	T30	5.5	120	82	22.7	99	5
03 13 14 40	2054TX	T40	6.6	140	102	22.7	110	5
03 13 14 45	2054TX	T45	7.8	140	102	22.7	111	5
03 13 14 50	1054TX	T50	8.8	140	102	22.7	143	5
03 13 14 55	1054TX	T55	11.2	140	102	22.7	159	5
03 13 14 60	1054TX	T60	13.2	140	100	23.7	221	5

Application: size T55 for the cylinder head screws on various Ford models, e.g. Mondeo 16V

1054TX

Screwdriver sockets

for inside TORX® screws, extra long, Chrome Alloy Steel, chrome plated.

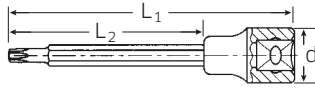



Code	size	mm	L ₁ mm	L ₂ mm	d mm	g	
03 13 12 40	T40	6.6	120	82	22.7	100	5
03 13 12 45	T45	7.8	120	82	22.7	100	5
03 13 10 70	T70	15.5	107	67	23.7	201	5

ES 1054/2054TX/6



175 x 175 x 30 mm, 6 pieces

Code	g
96 83 81 63	950

No 1054TX	No 2054TX	1/2" size	1/2" size
		○ size T30; T50; T55; T60	○ size T40; T45

83 81 20 81	Empty tray	55
-------------	------------	----

1054TX/4T

Set: Screwdriver sockets

for inside TORX® screws, in textile bag, 4 pieces, Content:

T40; T45; T50; T55





Code	g	
96 03 13 01	527	1

54TXB

Screwdriver sockets

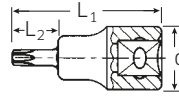
for inside TORX® screws, tamper proof, with hollow point, Chrome Alloy Steel, chrome plated (TORX® TAMPER RESISTANT).



Code	size	mm	L ₁ mm	L ₂ mm	d mm	g	
03 11 00 20	T20	3.8	55	17	22.7	70	5
03 11 00 25	T25	4.4	55	17	22.7	70	5
03 11 00 27	T27	5	55	17	22.7	71	5
03 11 00 30	T30	5.5	55	17	22.7	71	5
03 11 00 40	T40	6.6	55	17	22.7	71	5
03 11 00 45	T45	7.8	55	17	22.7	73	5
03 11 00 50	T50	8.8	55	17	22.7	86	5
03 11 00 55	T55	11.2	58	18	23.7	111	5
03 11 00 60	T60	13.2	58	18	23.7	113	5

Application: size T50 for the spare wheel retaining plate on the bumper of the Opel Frontera Sport

54TXB/9

Set: Screwdriver sockets

for inside TORX® screws, tamper proof, with hollow point (TORX® TAMPER RESISTANT).

9 pieces

Content: T20; T25; T27; T30; T40; T45; T50; T55; T60



Code	g	
96 03 10 07	810	1

in carton packing with transparent cover

54TXB/10

Set: Screwdriver sockets

for inside TORX® screws, tamper proof, with hollow point (TORX® TAMPER RESISTANT).

10 pieces

Content: T20; T25; T27; T30; 2 x T40; T45; T50; T55; T60



Code	g	
96 03 20 08	1185	1

in sturdy, stackable ABS plastic case

50CL

Clip strips

for socket retention, with 9 or 11 retaining clips. Supplied without sockets.



Code	size	L mm	g	
80 50 00 01	1	200	54	5
80 50 00 02	2	300	73	5

Drive tools and accessories

1/2" □, finish: Chrome Alloy Steel, chrome plated.

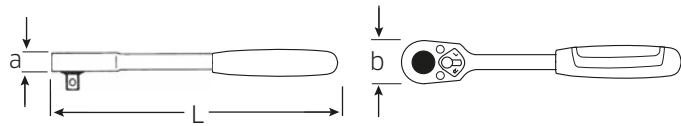

512 Ratchet

reversible, 36 teeth, with 2-component handle, DIN 3122/ISO 3315.



Code	L mm	b mm	a mm	⚖️ g	📦
13 11 10 10	265.5	41	22.5	600	1

512G Ratchet

reversible, 36 teeth, with 2-component handle, DIN 3122/ISO 3315. Encapsulated housing minimises the ingress of dirt.



Code	L mm	b mm	a mm	⚖️ g	📦
13 11 11 10	265.5	41	22.5	613	1

512QR N QuickRelease ratchet, fine tooth



reversible, 80 teeth, with QuickRelease safety lock and 2-component handle, for use in confined spaces, re-engages after movement of 4.5°, DIN 3122/ISO 3315, registered design.



Code	L mm	b mm	a mm	⚖️ g	📦
13 11 11 20	265.5	41	23	647	1

512SG-QR N QuickRelease ratchet, fine tooth



reversible, 80 teeth, with QuickRelease safety lock and steel handle, for use in confined spaces, re-engages after movement of 4.5°, construction without screws prevents foreign object damage, DIN 3122/ISO 3315, registered design.



Code	L mm	b mm	a mm	⚖️ g	📦
13 11 10 30	265.5	41	22.5	680	1

517QR QuickRelease fine-tooth flexible-joint ratchet



reversible, 80 teeth, with QuickRelease safety lock and 2-component handle, handle may be raised or lowered by approx. 90°. Lockable in following positions: straight, 30° up, 60° up, 30° down. Release the lock by pressing the button in the handle, for use in confined spaces, re-engages after movement of 4.5°, construction without screws prevents foreign object damage, DIN 3122/ISO3315, registered design.



Code	L mm	b mm	a mm	⚖️ g	📦
13 26 10 10	416	41	22	980	1

515 Ratchet, fine tooth

reversible, 60 teeth, with 2-component handle, for use in confined spaces, re-engages after movement of 6°, DIN 3122/ISO 3315.



Code	L mm	b mm	a mm	⚖️ g	📦
13 23 10 11	265	40	26.2	515	1

522 Ratchet adaptor

reversible, 20 teeth.



Code	L mm	∅ mm	⚖️ g	📦
13 14 00 00	67.5	40	316	1

532 Ratchet

long handle, reversible, 36 teeth, with 2-component handle.



Code	L mm	b mm	a mm	⚖️ g	📦
13 12 10 10	380	41	22.5	821	1

532G Ratchet

long handle, reversible, 36 teeth, with 2-component handle. Encapsulated housing minimises the ingress of dirt.



Code	L mm	b mm	a mm	⚖️ g	📦
13 12 11 10	380	41	22.5	815	1

512QR N/7 Set of wrenches

NEW



in sturdy, stackable ABS plastic case, 7 pieces

Content :

- 1 ratchet No 512QR N
- 4 extension No 509QR/2 (52 mm), No 509QR/3 (75 mm), No 509QR/5 (130 mm), No 509QR/10 (255 mm)
- 1 universal joint No 510QR, 1 T-handle No 506QR



Code	⚖️ g
96 03 40 10	2990

5120 + 7210/15 Spare parts set for ratchets No 512, 512SG, 532, 538

Content:

- 1 pinion; 1 pawl; 1 lever with pin; 1 ball; 2 compression springs; 2 screws.

Code	⚖️ g	📦
19 04 00 00	127	1

5120G Spare parts set for ratchets No 512G, 532G

Content:

- 1 pinion; 1 pawl; 1 lever with pin; 1 ball; 2 compression springs; 2 screws.

Code	⚖️ g	📦
19 04 00 30	120	1

12.5
1/2"

DIN
3120

ISO
1174-1

3

Sockets, Socket Sets

12.5
1/2"

DIN
3120

ISO
1174-1

5120QR N80 Spare parts set for ratchets No 512QR N, 512SG-QR N



for ratchet 512QR N, screwless design.

Content:

1 pinion; 1 locking disc; 1 lever; 1 pin; 1 ball; 1 compression spring; 2 circlips; 1 cover plate.

Code	\triangle g	
19042020	130	1

5120QR N Spare parts set for ratchet No 512QR N



for ratchet 512QR N, design with screws.

Content:

1 pinion; 1 pawl; 1 lever with pin; 1 ball; 2 compression springs; 2 screws.

Code	\triangle g	
19040040	140	1

5120QR Spare parts set for ratchets No 512QR, 512SG-QR



Content:

1 pinion; 1 pawl; 1 lever with pin; 1 ball; 2 compression springs; 2 screws.

Code	\triangle g	
19040020	118	1

7350/20 Spare parts set for ratchets No 515, 517

Content: 1 pinion; 1 pawl; 1 switching disk; 1 spring; 3 screws.

Code	\triangle g	
59251020	146	1

501 Speeder brace

working radius 105 mm,
DIN 3122/ISO 3315.



Code	L mm	\triangle g	
13100010	456	600	5

501QR QuickRelease speeder brace



with steel handle, for greater axial power transmission, detachable palm head, working radius 105 mm, DIN 3122/ISO 3315, with QuickRelease safety lock, patent.



Code	L mm	\triangle g	
13100005	456	886	1

504 Flexible handle

DIN 3122/ISO 3315,
with 2-component handle.



Code	size	L mm	\triangle g	
13061015	15	397	735	1
13061018	18	469	831	1
13061024	24	610	1051	1

5040N Spare parts set for No 504

for version with black, manganese-phosphated TORX® screw.

Content:

1 universal Joint
1 screw
1 spring Washer



Code	\triangle g	
96190801	80	1

5040 Spare parts set for No 504

for version with chrome plated Philips-head screw.

Content:

1 universal Joint
1 screw
1 spring Washer



Code	\triangle g	
96190800	75	1

506 Sliding T-handle

DIN 3122/ISO 3315.



Code	L mm	\triangle g	
13070000	300	436	5

506QR QuickRelease sliding T-handle



patent,
with QuickRelease safety lock.



Code	L mm	\triangle g	
13071000	300	470	1

509 Extensions

DIN 3123/ISO 3316.

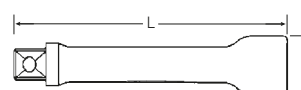

Code	size	L mm	d mm	\triangle g	
13010001	2	52	23	88	5
13010004	3	75	23.2	120	5
13010002	5	130	23.2	191	5
13010003	10	255	23.2	341	5

509W Extensions with wobble-drive

swivel angle 15° each side, maximum torque 200 N·m.

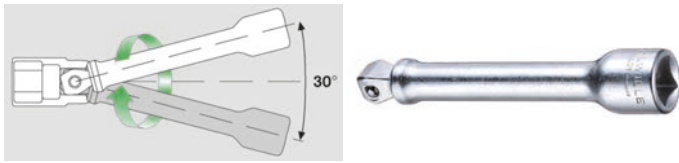

Code	size	L mm	d mm	Δ g	
13010005	2	52	23	80	5
13010006	3	75	23.2	120	5
13010007	5	130	23.2	191	5
13010008	10	255	23.2	341	5

509QR QuickRelease extensions

QR

patent, DIN 3123/ISO 3316.



Code	size	L mm	d mm	Δ g	
13011001	2	52	23	90	1
13011004	3	75	23	123	1
13011002	5	130	23	187	1
13011003	10	255	23	341	1

3505 Special extension



Code	L mm	d mm	Δ g	
13210001	120	23.2	186	1

510 Universal joint

DIN 3123/ISO 3316.



Code	L mm	d mm	Δ g	
13020000	71	25	146	5

510QR QuickRelease universal joint

QR

patent, DIN 3123/ISO 3316, with QuickRelease safety lock.



Code	L mm	d mm	Δ g	
13021000	80	25	155	1

5513 Set of adaptors

NEW

No 409, 1/4" socket x 3/8" plug
No 431, 3/8" socket x 1/4" plug
No 432, 3/8" socket x 1/2" plug
No 513, 1/2" socket x 3/8" plug
No 514, 1/2" socket x 3/4" plug



Code	Δ g	
96121003	648	1

513 Adaptor

HPQ

1/2" socket x 3/8" plug (12.5 x 10), maximum torque 202 N·m, DIN 3123/ISO 3316, HPQ® high performance steel.



Code	L mm	d mm	Δ g	
13030002	35	22.7	55	5

514 Adaptor

HPQ

1/2" socket x 3/4" plug (12.5 x 20), DIN 3123/ISO 3316, HPQ® high performance steel.



Code	L mm	d mm	Δ g	
13030005	44	25	118	5

7789-1 Adaptor

HPQ

1/2" socket x 1" plug (12.5 x 25), HPQ® high performance steel.



Code	L mm	d mm	Δ g	
58522089	35	36.5	175	1

409M/432M/514M/3 Set of adaptors, 3 pieces

1/4" socket x 3/8" plug,
3/8" socket x 1/2" plug,
1/2" socket x 3/4" plug.



Code	Δ g	
96121002	120	1

514M Adaptor

1/2" socket x 3/4" plug (12.5 x 20).



Code	L mm	ϕ mm	Δ g	
13030010	22	38	40	1

12.5
1/2"

DIN
3120

ISO
1174-1

3

Sockets, Socket Sets

12.5
1/2"

DIN
3120

ISO
1174-1

3

543 Bit holder

Ø 5/16" inside hexagon, DIN 3126/ISO 1173 D 8. Internal hex drive with a collar-thrust spring. Bits are easy to insert, lock securely in position and can be removed just as easily; even hex bits with a wide groove (Type E, DIN 3126/ISO 1173).



Code	L mm	d mm	⚖ g	📦
13 1800 10	38	22	65	5

52/9/3 Socket set 1/2" □

in sturdy, stackable ABS plastic case, 12 pieces

Content:
9 sockets with hexagon No 52:
sizes 10; 13; 16; 17; 18; 19; 21;
22; 24 mm
1 ratchet No 512
2 extensions No 509/5 (130 mm),
No 509/10 (255 mm)

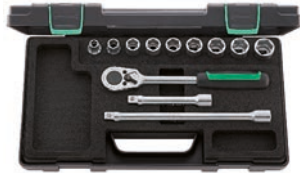

Code	⚖ g
9603 1343	2747

50/12/3 Socket set 1/2" □

in sturdy, stackable ABS plastic case, 15 pieces

Content:
12 sockets with bi-hexagon No 50:
sizes 10; 13; 16; 17; 18; 19; 21;
22; 24; 27; 30; 32 mm
1 ratchet No 512
2 extensions
No 509/5 (130 mm),
No 509/10 (255 mm)



Code	⚖ g
9603 1435	2739

52/12/3 Socket set 1/2" □

in sturdy, stackable ABS plastic case, 15 pieces

Content:
12 sockets with hexagon No 52:
sizes 10; 13; 16; 17; 18; 19; 21; 22;
24; 27; 30; 32 mm
1 ratchet No 512
2 extensions No 509/5 (130 mm),
No 509/10 (255 mm)



Code	⚖ g
9603 1436	3562

52/16/5 Socket set 1/2" □

in sturdy, stackable ABS plastic case, 21 pieces

Content:
15 sockets with hexagon No 52:
sizes 10; 11; 12; 13; 14; 15; 16; 17;
18; 19; 21; 22; 24; 27; 30 mm
1 socket, long, with rubber insert
No 51: sizes 16 mm - 5/8"
1 ratchet No 512
2 extensions No 509/5 (130 mm), No 509/10 (255 mm)
1 T-handle No 506
1 universal joint No 510



Code	⚖ g
9603 1406	4635

54/8/4 Socket set 1/2" □

in sturdy, stackable ABS plastic case, 12 pieces

Content:
8 INHEX sockets No 54:
sizes 4; 5; 6; 8; 10; 12; 14; 17 mm
1 ratchet No 512
2 extensions No 509/5 (130 mm),
No 509/10 (255 mm)
1 T-handle No 506



Code	⚖ g
9603 1501	3636

50/16/6 Socket set 1/2" □

in sturdy, stackable ABS plastic case, 22 pieces

Content:
16 sockets with bi-hexagon No 50:
sizes 10; 11; 12; 13; 14; 15; 16; 17;
18; 19; 21; 22; 24; 27; 30; 32 mm
1 ratchet No 512
3 extensions No 509/3 (75 mm),
No 509/5 (130 mm), No 509/10 (255 mm)
1 T-handle No 506
1 universal joint No 510



Code	⚖ g
9603 1447	4827

50/16/6QR Socket set 1/2" □ NEW

QR in sturdy, stackable ABS plastic case, 22 pieces

Content:
16 sockets with bi-hexagon No 50:
sizes 10; 11; 12; 13; 14; 15; 16; 17;
18; 19; 21; 22; 24; 27; 30; 32 mm
1 ratchet No 512QR N
3 extensions No 509QR/3 (75 mm),
No 509QR/5 (130 mm), No 509QR/10 (255 mm)
1 T-handle No 506QR
1 universal joint No 510QR



Code	⚖ g
9603 1446	4502

52/16/6 Socket set 1/2" □

in sturdy, stackable ABS plastic case, 22 pieces

Content:
16 sockets with hexagon No 52:
sizes 10; 11; 12; 13; 14; 15; 16; 17;
18; 19; 21; 22; 24; 27; 30; 32 mm
1 ratchet No 512
3 extensions No 509/3 (75 mm),
No 509/5 (130 mm), No 509/10 (255 mm)
1 T-handle No 506
1 universal joint No 510



Code	⚖ g
9603 1448	4810

52/16/6QR Socket set 1/2"



in sturdy, stackable ABS plastic case,
22 pieces

Content:

- 16 sockets with hexagon No 52: sizes 10; 11; 12; 13; 14; 15; 16; 17; 18; 19; 21; 22; 24; 27; 30; 32 mm
- 1 ratchet No 512QR N
- 3 extensions No 509QR/3 (75 mm), No 509QR/5 (130 mm), No 509QR/10 (255 mm)
- 1 T-handle No 506QR N
- 1 universal joint No 510QR



Code	ΔΔ g
9603 1480	4765

50/22/6 Socket set 1/2"

in sturdy, stackable ABS plastic case,
28 pieces

Content:

- 22 sockets with bi-hexagon No 50: sizes 8; 9; 10; 11; 12; 13; 14; 15; 16; 17; 18; 19; 20; 21; 22; 23; 24; 26; 27; 28; 30; 32 mm
- 1 ratchet No 512
- 3 extensions No 509/3 (75 mm), No 509/5 (130 mm), No 509/10 (255 mm)
- 1 T-handle No 506
- 1 universal joint No 510



Code	ΔΔ g
9603 1407	5410

52/22/6 Socket set 1/2"

in sturdy, stackable ABS plastic case,
28 pieces

Content:

- 22 sockets with hexagon No 52: sizes 8; 9; 10; 11; 12; 13; 14; 15; 16; 17; 18; 19; 20; 21; 22; 23; 24; 26; 27; 28; 30; 32 mm
- 1 ratchet No 512
- 3 extensions No 509/3 (75 mm), No 509/5 (130 mm), No 509/10 (255 mm)
- 1 T-handle No 506
- 1 universal joint No 510



Code	ΔΔ g
9603 1409	5360

50ma/39/6N Socket set 1/2"

in sturdy sheet steel case,
45 pieces

Content:

- 39 sockets with bi-hexagon
 - No 50: sizes 10; 11; 12; 13; 14; 15; 16; 17; 18; 19; 20; 21; 22; 23; 24; 25; 26; 27; 28; 30; 32; 34 mm
 - No 50a: sizes 3/8; 7/16; 1/2; 9/16; 19/32; 5/8; 11/16; 3/4; 25/32; 13/16; 7/8; 15/16; 1; 1 1/16; 1 1/8; 1 3/16; 1 1/4"
- 1 ratchet No 512
- 3 extensions No 509/3 (75 mm), No 509/5 (130 mm), No 509/10 (255 mm)
- 1 T-handle No 506
- 1 universal joint No 510



Code	ΔΔ g
9603 01 40	9020

50ma/39/6QR Socket set 1/2"



in sturdy sheet steel case,
45 pieces

Content:

- 39 sockets with bi-hexagon
 - No 50: sizes 10; 11; 12; 13; 14; 15; 16; 17; 18; 19; 20; 21; 22; 23; 24; 25; 26; 27; 28; 30; 32; 34 mm
 - No 50a: sizes 3/8; 7/16; 1/2; 9/16; 19/32; 5/8; 11/16; 3/4; 25/32; 13/16; 7/8; 15/16; 1; 1 1/16; 1 1/8; 1 3/16; 1 1/4"
- 1 ratchet No 512QR N
- 3 extensions No 509QR/3 (75 mm), No 509QR/5 (130 mm), No 509QR/10 (255 mm)
- 1 T-handle No 506QR
- 1 universal joint No 510QR



Code	ΔΔ g
9603 01 07	9020

40/52/27/11 Socket set 1/4; 1/2"

in sturdy, stackable ABS plastic case,
38 pieces

Content:

- 9 sockets with hexagon No 40: sizes 4; 5; 5.5; 6; 7; 8; 9; 10; 11 mm
- 10 sockets with hexagon No 52: sizes 13; 16; 17; 18; 19; 21; 22; 24; 27; 30 mm
- 3 INHEX sockets No 44: sizes 3; 4; 5 mm
- 5 INHEX sockets No 54: sizes 6; 8; 10; 12; 14 mm
- 2 ratchets No 415, No 512
- 4 extensions No 405/2 (54 mm), No 509/5 (130 mm), No 405/6 (150 mm), No 509/10 (255 mm)
- 2 universal joints No 407, No 510
- 1 drive handle No 400
- 2 T-handles No 404, No 506



Code	ΔΔ g
9601 11 60	5145

50/43/7 Socket set 1/2"

in sturdy sheet steel case,
50 pieces

Content:

- 23 sockets with bi-hexagon No 50: sizes 8; 10; 11; 12; 13; 14; 15; 16; 17; 18; 19; 20; 21; 22; 23; 24; 25; 26; 27; 28; 30; 32; 34 mm
- 7 sockets, long, No 51: sizes 13; 17; 18; 19; 22; 24; 27 mm
- 2 sockets, long, with rubber insert No 51: sizes 16 mm - 5/8", 20.8 mm - 13/16"
- 6 UNIFLEX sockets with hexagon No 53: sizes 10; 13; 16; 17; 18; 19 mm
- 5 INHEX sockets No 54: sizes 4; 5; 6; 8; 10 mm
- 1 ratchet No 512
- 3 extensions No 509/3 (75 mm), No 509/5 (130 mm), No 509/10 (255 mm)
- 1 flexible handle No 504/15
- 1 T-handle No 506
- 1 universal joint No 510



Code	ΔΔ g
9603 01 36	10710

Sockets, Socket Sets

12.5
1/2"

DIN
3120

ISO
1174-1

50/54/25/6 Socket set 1/2"

in sturdy, stackable ABS plastic case,
31 pieces

- Content:
- 17 sockets with bi-hexagon No 50:
sizes 8; 10; 11; 12; 13; 14; 15;
16; 17; 18; 19; 21; 22; 24; 27;
30; 32 mm
 - 8 INHEX sockets No 54:
sizes 4; 5; 6; 7; 8; 10; 12; 14 mm
 - 1 ratchet No 512
 - 3 extensions No 509/3 (75 mm), No 509/5 (130 mm),
No 509/10 (255 mm)
 - 1 T-handle No 506
 - 1 universal joint No 510



Code	
	g
9603 1439	5579

52/54/25/6QR Socket set 1/2"

NEW

QR

in sturdy, stackable ABS plastic case,
31 pieces

- Content:
- 17 sockets with hexagon No 52:
sizes 8; 10; 11; 12; 13; 14; 15;
16; 17; 18; 19; 21; 22; 24; 27;
30; 32 mm
 - 8 INHEX sockets No 54: sizes 4; 5; 6; 7; 8; 10; 12; 14 mm
 - 1 ratchet No 512QR N
 - 3 extensions No 509QR/3 (75 mm), No 509QR/5 (130 mm),
No 509QR/10 (255 mm)
 - 1 T-handle No 506QR
 - 1 universal joint No 510QR



Code	
	g
9603 1240	5306

3

50/54/25/6QR Socket set 1/2"

NEW

QR

in sturdy, stackable ABS plastic case,
31 pieces

- Content:
- 17 sockets with bi-hexagon No 50:
sizes 8; 10; 11; 12; 13; 14; 15;
16; 17; 18; 19; 21; 22; 24; 27;
30; 32 mm
 - 8 INHEX sockets No 54: sizes 4; 5; 6; 7; 8; 10; 12; 14 mm
 - 1 ratchet No 512QR NN
 - 3 extensions No 509QR/3 (75 mm), No 509QR/5 (130 mm),
No 509QR/10 (255 mm)
 - 1 T-handle No 506QR
 - 1 universal joint No 510QR



Code	
	g
9603 1440	4502

87 Socket set 1/2"

in sturdy, stackable ABS plastic case,
47 pieces

- Content:
- 19 sockets with bi-hexagon No 50:
sizes 8; 9; 10; 11; 12; 13; 14;
15; 16; 17; 18; 19; 21; 22; 24;
27; 30; 32; 34 mm
 - 2 sockets, long, with rubber insert,
No 51: sizes 16 mm - 5/8";
20.8 mm - 13/16"
 - 7 INHEX sockets No 54:
sizes 4; 5; 6; 7; 8; 10; 12 mm
 - 13 combination spanners No 13:
sizes 10; 11; 12; 13; 14; 15; 16;
17; 18; 19; 21; 22; 24 mm
 - 1 ratchet No 512
 - 3 extensions No 509/3 (75 mm), No 509/5 (130 mm),
No 509/10 (255 mm)
 - 1 T-handle No 506
 - 1 universal joint No 510



Code	
	g
9603 1101	8059

52/54/25/6 Socket set 1/2"

in sturdy, stackable ABS plastic case,
31 pieces

- Content:
- 17 sockets with hexagon No 52:
sizes 8; 10; 11; 12; 13; 14; 15;
16; 17; 18; 19; 21; 22; 24; 27;
30; 32 mm
 - 8 INHEX sockets No 54:
sizes 4; 5; 6; 7; 8; 10; 12; 14 mm
 - 1 ratchet No 512
 - 3 extensions No 509/3 (75 mm), No 509/5 (130 mm),
No 509/10 (255 mm)
 - 1 T-handle No 506
 - 1 universal joint No 510



Code	
	g
9603 1239	5590

876 Socket set 1/2"

in sturdy, stackable ABS plastic case,
47 pieces

- Content:
- 19 sockets with hexagon No 52:
sizes 8; 9; 10; 11; 12; 13; 14;
15; 16; 17; 18; 19; 21; 22; 24;
27; 30; 32; 34 mm
 - 2 sockets, long, with rubber insert,
No 51: sizes 16 mm - 5/8";
20.8 mm - 13/16"
 - 7 INHEX sockets No 54:
sizes 4; 5; 6; 7; 8; 10; 12 mm
 - 13 combination spanners No 13:
sizes 10; 11; 12; 13; 14; 15; 16;
17; 18; 19; 21; 22; 24 mm
 - 1 ratchet No 512
 - 3 extensions No 509/3 (75 mm), No 509/5 (130 mm),
No 509/10 (255 mm)
 - 1 T-handle No 506
 - 1 universal joint No 510



Code	
	g
9603 2301	8034



50TX/16/5 Socket set TORX® 1/2"

in sturdy, stackable ABS plastic case,
21 pieces

Content:

- 7 sockets for external TORX® screws
No 50TX: sizes E10; E12; E14;
E16; E18; E20; E24
- 9 screwdriver sockets for internal
TORX® screws No 54TX:
sizes T20; T25; T27; T30; T40;
T45; T50; T55; T60
- 1 ratchet No 512
- 3 extensions No 509/2 (52 mm), No 509/5 (130 mm),
No 509/10 (255 mm)
- 1 universal joint No 510



Code	Δ g
96033702	4013

876TX Socket set TORX® 1/2"

in sturdy, stackable ABS plastic case,
39 pieces

Content:

- 12 sockets with hexagon No 52:
sizes 8; 10; 13; 16; 17; 18; 19;
21; 22; 24; 27; 30 mm
- 6 INHEX sockets No 54:
sizes 5; 6; 8; 10; 12; 14 mm
- 7 sockets for external TORX®
screws No 50TX:
sizes E10; E12; E14; E16; E18; E20; E24
- 9 screwdriver sockets for internal TORX® screws No 54TX:
sizes T20; T25; T27; T30; T40; T45; T50; T55; T60
- 1 ratchet No 512
- 2 extensions No 509/5 (130 mm), No 509/10 (255 mm)
- 1 T-handle No 506
- 1 universal joint No 510

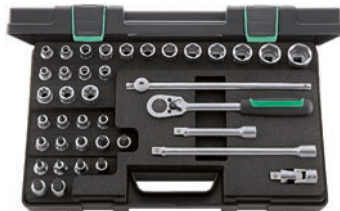

Code	Δ g
98811909	6574

86TX Socket set TORX® 1/4; 1/2"

in sturdy, stackable ABS plastic case,
63 pieces

Content:

- 9 sockets with hexagon No 40:
sizes 4; 5; 5.5; 6; 7; 8; 9; 10;
11 mm
- 10 sockets with hexagon No 52:
sizes 13; 16; 17; 18; 19; 21; 22;
24; 27; 30 mm
- 5 sockets for external TORX® screws No 40TX:
sizes E4; E5; E6; E7; E8
- 7 sockets for external TORX® screws No 50TX:
sizes E10; E12; E14; E16; E18; E20; E24
- 3 INHEX sockets No 44: sizes 3; 4; 5 mm
- 5 INHEX sockets No 54: sizes 6; 8; 10; 12; 14 mm
- 6 screwdriver sockets for internal TORX® screws No 44KTX:
sizes T8; T9; T10; T15; T20; T25
- 7 screwdriver sockets for internal TORX® screws No 54TX:
sizes T27; T30; T40; T45; T50; T55; T60
- 2 ratchets No 415, No 512
- 4 extensions No 405/2 (54 mm), No 509/5 (130 mm),
No 405/6 (150 mm), No 509/10 (255 mm)
- 2 universal joints No 407, No 510
- 1 drive handle No 400
- 2 T-handles No 404, No 506



Code	Δ g
96013702	6734

89TX Socket set TORX® 1/4; 3/8; 1/2"

in sturdy, stackable ABS plastic case,
35 pieces

Content:

- 3 sockets for external TORX® screws
No 40TX: sizes E4; E5; E6
- 2 screwdriver sockets for internal
TORX® screws No 44KTX:
sizes T8; T9
- 4 sockets for external TORX® screws
No 45TX: sizes E7; E8; E10; E12
- 5 screwdriver sockets for internal TORX® screws No 49TX:
sizes T10; T15; T20; T25; T27
- 6 sockets for external TORX® screws No 50TX:
sizes E11; E14; E16; E18; E20; E24
- 6 screwdriver sockets for internal TORX® screws No 54TX:
sizes T30; T40; T45; T50; T55; T60
- 7 bits 1440: T10; 1441: T15; 1442: T20; 1443: T25; 1444: T27;
1445: T30; 1446: T40
- 1 bit-holder No 442
- 1 TORX® controller: sizes E6; E7; E8; E10; E12; E14; E16; T10; T15; T20;
T25; T27; T30; T40; T45; T47; T50; T55; T60

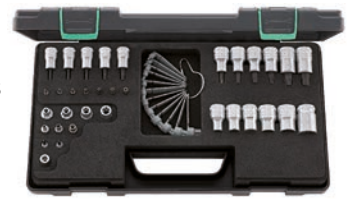

Code	Δ g
98811908	2568

50a/17/6 Socket set 1/2"

in sturdy, stackable ABS plastic case,
23 pieces

Content:

- 17 sockets with bi-hexagon No 50a:
sizes 3/8; 7/16; 1/2; 9/16; 19/32; 5/8;
11/16; 3/4; 25/32; 13/16; 7/8; 15/16; 1;
1 1/16; 1 1/8; 1 3/16; 1 1/4"
- 1 ratchet No 512
- 3 extensions No 509/2 (52 mm),
No 509/5 (130 mm), No 509/10 (255 mm)
- 1 T-handle No 506
- 1 universal joint No 510



Code	Δ g
96035125	5015

87a Socket set 1/2"

in sturdy, stackable ABS plastic case,
40 pieces

Content:

- 15 sockets with bi-hexagon No 50a:
sizes 3/8; 7/16; 1/2; 9/16; 5/8; 11/16;
3/4; 13/16; 7/8; 15/16; 1; 1 1/16; 1 1/8;
1 3/16; 1 1/4"
- 2 sockets, long, with rubber insert,
No 51: sizes 16 mm - 5/8";
20.8 mm - 13/16"
- 5 INHEX sockets No 54a:
sizes 7/32; 1/4; 5/16; 3/8; 1/2"
- 12 combination spanners No 13a:
sizes 1/4; 5/16; 11/32; 3/8; 7/16; 1/2;
9/16; 5/8; 11/16; 3/4; 13/16; 7/8"
- 1 ratchet No 512
- 3 extensions No 509/2 (52 mm), No 509/5 (130 mm),
No 509/10 (255 mm)
- 1 T-handle No 506
- 1 universal joint No 510



Code	Δ g
96035101	7219

12.5
1/2"

DIN
3120

ISO
1174-1

3

Sockets, Socket Sets

12.5
1/2"

DIN
3120

ISO
1174-1

3

ES 1/2"-512/6



175 x 350 x 35 mm, 6 pieces

Code		g
96838113		1915
No 506	1/2" ■ 300 mm	
No 509/2	1/2" ■ ○ 52 mm	
No 509/5	1/2" ■ ○ 130 mm	
No 509/10	1/2" ■ ○ 255 mm	
No 510	1/2" ■ ○ 71 mm	
No 512	1/2" ■	
83812029	Empty tray	110

TCS 1/2"-512/6

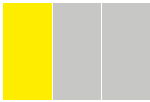

TCS



175 x 350 x 35 mm, 6 pieces

Code		g
96838175		1845
No 506	1/2" ■ 300 mm	
No 509/2	1/2" ■ ○ 52 mm	
No 509/5	1/2" ■ ○ 130 mm	
No 509/10	1/2" ■ ○ 255 mm	
No 510	1/2" ■ ○ 71 mm	
No 512	1/2" ■	

TCS 1/2"-512/9



TCS



175 x 350 x 40 mm, 9 pieces

Code		g
96830603		2364
No 506	1/2" ■ 300 mm	
No 509QR/2	1/2" ■ ○ 52 mm	
No 509/5	1/2" ■ ○ 130 mm	
No 509QR/10	1/2" ■ ○ 255 mm (2x)	
No 510	1/2" ■ ○ 71 mm	
No 512	1/2" ■	
No 513	3/8" ■ 1/2" ○	
No 514	3/4" ■ 1/2" ○	

TCS 50/52/30/6 MF



TCS

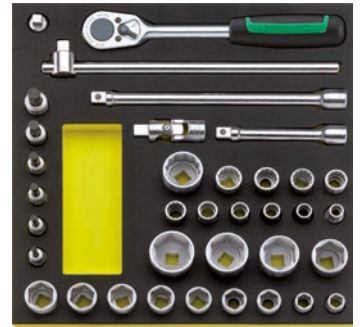

350 x 350 x 70 mm, 36 pieces

Code		g
96830354		4604
No 50	1/2" ○ sizes 10; 11; 12; 13; 14; 15; 16; 17; 18; 19; 30 mm	
No 52	1/2" ○ sizes 12; 13; 17; 18; 19; 20; 21; 22; 24; 27; 30; 32; 34 mm	
No 54	1/2" ○ sizes 5; 6; 7; 8; 10; 12 mm	
No 506	1/2" ■ 300 mm	
No 509/5	1/2" ■ ○ 130 mm	
No 509/10	1/2" ■ ○ 255 mm	
No 510	1/2" ■ ○ 71 mm	
No 512	1/2" ■	
No 513	3/8" ■ 1/2" ○	

TCS 52/14/4

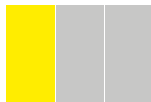

TCS



175 x 350 x 50 mm, 18 pieces

Code		g
96838781		2510
No 52	1/2" ○ sizes 10; 11; 12; 13; 14; 15; 16; 17; 18; 19; 22; 24; 27; 30 mm	
No 509/5	1/2" ■ ○ 130 mm	
No 509/10	1/2" ■ ○ 255 mm	
No 510	1/2" ■ ○ 71 mm	
No 512	1/2" ■	

55 Sockets



DIN 3124/ISO 2725-1, ASME B 107.5 M, AS-drive and HPQ® high performance steel up to size 38, chrome plated.

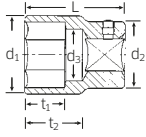

Code	Ø mm	d ₁ mm	d ₂ mm	d ₃ mm	L mm	t ₁ mm	t ₂ mm	Δg	g	
05010019	19	28.5	34.7	17	50	16	26	183	5	
05010021	21	31	34.7	18	50	16	26	226	5	
05010022	22	32	34.7	19	51	17	25.2	199	5	
05010024	24	34	34.7	21	51	18.5	24.6	200	5	
05010027	27	38.5	38	24	54	20	26.8	263	5	
05010030	30	42	38	27	58	21	33.6	313	5	
05010032	32	44.5	38	29	58	22	33	326	2	
05010033	33	46	40	30	60	22	34.7	372	2	
05010034	34	47	40	31	60	24	34.4	363	2	
05010036	36	49.5	40	33	60	24	33.9	386	2	
05010038	38	52	40	35	64	30	37.3	429	2	
05010041	41	55.5	40	33	67	30	37.5	498	2	
05010046	46	61	40	33	73	34	43.5	605	1	
05010050	50	66	40	33	80	34	48.5	769	1	
05010055	55	72	45	33	80	36	49.5	954	1	
05010060	60	78	45	33	80	40	50.5	1025	1	

55a Sockets



SAE AS 954-E (test loads), ASME B 107.1, AS-drive and HPQ® high performance steel up to size 1 1/2", chrome plated.

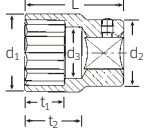

Code	Ø"	d ₁ mm	d ₂ mm	d ₃ mm	L mm	t ₁ mm	t ₂ mm	Δg	g	
05410040	3/4	28.5	34.7	18.6	50	16	26	176	2	
05410042	13/16	31	34.7	19.4	51	16.5	25.1	190	2	
05410044	7/8	33	34.7	21	51	18	24.5	240	2	
05410046	15/16	34	34.7	22.5	51	18.5	24.2	248	2	
05410048	1	37	38	24	52	20	24.8	251	2	
05410050	1 1/16	38.5	38	26	54	20	26.2	265	2	
05410052	1 1/8	41	38	27.5	57	20	32.5	297	2	
05410056	1 1/4	44.5	38	30.5	58	22	32.6	339	2	
05410058	1 5/16	46.5	40	32.1	59	24	33.1	368	2	
05410060	1 3/8	48.5	40	33.7	59	24	32.7	375	2	
05410062	1 7/16	50	40	35.3	60	27	33.2	395	2	
05410064	1 1/2	52	40.5	36.8	64	30	36.8	415	2	
05410066	1 5/8	56	40	33	67	30	37.5	469	1	
05410067	1 11/16	58	40	33	70	32	40.5	524	1	
05410068	1 3/4	59.5	40	33	70	32	40.5	524	1	
05410069	1 13/16	61.5	40	33	73	34	43.5	585	1	
05410070	1 7/8	63.5	40	33	76	34	45	651	1	
05410072	2	67	40	33	80	34	48.5	757	1	

56 Sockets



DIN 3124/ISO 2725-1, ASME B 107.5 M, extra deep, AS-drive and HPQ® high performance steel up to size 36, chrome plated.

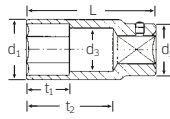

Code	Ø mm	d ₁ mm	d ₂ mm	d ₃ mm	L mm	t ₁ mm	t ₂ mm	Δg	g	
05020022	22	32	34.7	19	90	40	64.2	374	5	
05020024	24	34	34.7	21	90	40	63.6	341	5	
05020027	27	38.5	38	24	90	40	62.8	443	5	
05020030	30	42	38	27	90	40	65.6	477	5	
05020032	32	44.5	38	29	90	40	65	526	2	
05020034	34	47	40	31	90	40	64.4	562	2	
05020036	36	49.5	40	33	90	40	63.9	620	2	
05020041	41	55.5	40	38	90	40	58.5	714	2	

59 INHEX sockets

for socket head screws, DIN 7422, Chrome Alloy Steel, chrome plated.

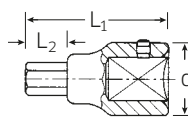

Code	mm	L ₁ mm	L ₂ mm	d mm	Δg	g	
05050014	14	80	25	34.7	272	1	
05050017	17	80	25	34.7	311	1	
05050019	19	80	25	34.7	346	1	
05050022	22	80	25	40	515	1	

59X Screwdriver sockets

for trisquare socket head screws (XZN®), Chrome Alloy Steel, chrome plated.

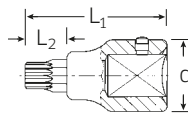

Code	size	L ₁ mm	L ₂ mm	d mm	Δg	g	
05060014	M14	90	35	34.7	281	1	
05060016	M16	80	25	34.7	302	1	
05060018	M18	100	45	34.7	315	1	

Application: Flywheel and oscillation damper on Mercedes-Benz commercial vehicles

59TX Screwdriver sockets

for inside TORX® screws, Chrome Alloy Steel, chrome plated.

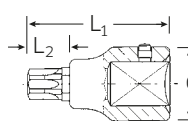

Code	size	mm	L ₁ mm	L ₂ mm	d mm	Δg	g	
05100060	T60	13.2	80	25	34.7	265	1	
05100070	T70	15.5	80	25	34.7	285	1	
05100080	T80	17.6	80	25	34.7	300	1	
05100090	T90	19.9	80	25	34.7	331	1	
05100100	T100	22.1	80	25	40	474	1	

Application: size T80 for MAN series M, size T100 for MAN series F

20
3/4"

DIN
3120

ISO
1174-1

3

Sockets, Socket Sets

20
3/4"

DIN
3120

ISO
1174-1

Drive tools and accessories

3/4" □, finish: Chrome Alloy Steel, chrome plated.

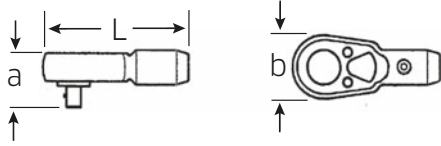

552 Ratchet

QR

reversible, 36 teeth, with QuickRelease safety lock, without Bar handle No 558.



Code	L mm	b mm	a mm	△g	g	☐
15 11 0000	165	70	55	1670		1

5520 Spare parts set for ratchet No 552

Content:
1 pinion, 1 pawl, 1 lever, 1 ball, 1 compression spring, 2 screws

Code	△g	g	☐
19 05 0000	536		1

563 Ratchet adaptor

reversible, 44 teeth.



Code	L mm	∅ mm	△g	g	☐
15 14 0000	105.5	63	1257		1

554 Flexible head

QR

with QuickRelease safety lock, without Bar handle No 558.



Code	L mm	d mm	△g	g	☐
15 06 0000	132	40	795		5

556 Sliding head

without Bar handle No 558.



Code	L mm	d mm	△g	g	☐
15 07 0000	61.5	40	318		5

558 Bar handle



Code	L mm	d mm	△g	g	☐
15 17 0000	510	20	1259		2

559 Extensions

DIN 3123/ISO 3316.

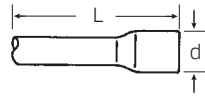

Code	size	L mm	d mm	△g	g	☐
15 01 0003	4	95	35	369		5
15 01 0001	8	200	35	696		5
15 01 0002	16	400	35	1255		5

561 Universal joint

DIN 3123/ISO 3316.



Code	L mm	d mm	△g	g	☐
15 02 0000	109	40	566		1

568 Adaptor

HPQ

3/4" socket x 1/2" plug (20 x 12.5), maximum torque 512 N·m, DIN 3123/ISO 3316, HPQ® high performance steel.



Code	L mm	d mm	△g	g	☐
15 03 0003	55	34.7	203		5

569 Adaptor

HPQ

3/4" inside x 1" plug (20 x 25), DIN 3123/ISO 3316, HPQ® high performance steel.



Code	L mm	d mm	△g	g	☐
15 03 0006	61	34.7	295		5

55/10/6 Socket set 3/4" □

in sturdy sheet steel case,

16 pieces

Content:

- 10 sockets with hexagon No 55: sizes 22; 24; 27; 30; 32; 34; 36; 41; 46; 50 mm
- 1 ratchet No 552
- 2 extensions No 559/8 (200 mm), No 559/16 (400 mm)
- 1 flexible head No 554
- 1 sliding head for T-handle No 556
- 1 bar handle No 558



Code	△g	g
96 05 01 04	13965	

55/9/6N Socket set 3/4" □

in sturdy sheet steel case,
15 pieces
Content:
9 sockets with hexagon No 55:
sizes 32; 34; 36; 38; 41; 46; 50;
55; 60 mm
1 ratchet No 552
2 extensions No 559/8 (200 mm),
No 559/16 (400 mm)
1 flexible head No 554
1 sliding head for T-handle No 556
1 bar handle No 558



Code	ΔΔ g
96 05 01 03	15731

55a/10/5 Socket set 3/4" □

in sturdy sheet steel case,
15 pieces
Content:
10 sockets with bi-hexagon
No 55a: sizes 1 1/16; 1 1/8; 1 1/4;
1 3/8; 1 7/16; 1 1/2; 1 5/8; 1 3/4;
1 13/16; 1 7/8"
1 ratchet No 552
2 extensions
No 559/8 (200 mm), No 559/16 (400 mm)
1 sliding head for T-handle No 556
1 bar handle No 558



Code	ΔΔ g
96 05 41 01	12620

55a/16/6 Socket set 3/4" □

in sturdy sheet steel case,
22 pieces
Content:
16 sockets with bi-hexagon No 55a:
sizes 7/8; 15/16; 1; 1 1/16; 1 1/8;
1 1/4; 1 5/16; 1 3/8; 1 7/16; 1 1/2;
1 5/8; 1 11/16; 1 3/4; 1 13/16; 1 7/8; 2"
1 ratchet No 552
2 extensions No 559/8 (200 mm),
No 559/16 (400 mm)
1 flexible head No 554
1 sliding head for T-handle No 556
1 bar handle No 558



Code	ΔΔ g
96 05 41 03	16750

ES 55/6/4



530 x 350 x 83 mm, 10 pieces

Code	ΔΔ g
96 83 81 74	7875

	No 55	3/4" ○ sizes 34; 36; 41; 46; 50; 55 mm
	No 552	3/4" ■
	No 556	3/4" ■
	No 558	510 mm
	No 559/8	3/4" ■ ○ 200 mm
83 81 20 89	Empty tray	298

TCS 55/11/6



TCS



530 x 350 x 90 mm, 17 pieces

Code	ΔΔ g
96 83 02 21	10100

	No 55	3/4" ○ sizes 22; 24; 27; 30; 32; 34; 36; 38; 41; 46; 50 mm
	No 552	3/4" ■
	No 556	3/4" ■
	No 558	510 mm
	No 559/8	3/4" ■ ○ 200 mm
	No 559/16	3/4" ■ ○ 400 mm
	No 568	1/2" ■ 3/4" ○

STAHLWILLE »AS-Drive«



STAHLWILLE sockets are equipped with the AS-Drive* profile: this permits high transmission of forces to the lands of nuts and bolts without damaging them. No longer will you have to worry about stripping the corners off nuts and bolts.

*Anti-Slip-Drive

Sockets, Socket Sets

25
1"

DIN
3120

ISO
1174-1

3

60 Sockets



DIN 3124/ISO 2725-1, AS-drive and HPQ® high performance steel up to size 36, chrome plated.

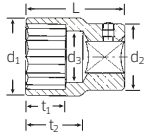

Code	mm	d ₁ mm	d ₂ mm	d ₃ mm	L mm	t ₁ mm	t ₂ mm	g	g	g
06 01 00 30	30	42.5	43	27	65	20	33.1	371	2	
06 01 00 32	32	45	43	29	67	24	34.6	374	2	
06 01 00 34	34	47	43	31	67	24	34	398	2	
06 01 00 36	36	49.5	48	33	67	24	33.4	493	2	
06 01 00 41	41	55.5	48	36	70	30	37.5	520	1	
06 01 00 46	46	61	49	40	75	32	43.5	622	1	
06 01 00 50	50	66	48	43	80	34	47.5	707	1	
06 01 00 55	55	72	48	49	85	36	49.5	920	1	
06 01 00 60	60	78	48	53	90	40	56.5	992	1	

60 Sockets

DIN 3124, Chrome Alloy Steel, chrome plated.

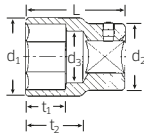

Code	mm	d ₁ mm	d ₂ mm	d ₃ mm	L mm	t ₁ mm	t ₂ mm	g	g	g
06 01 00 65	65	87	60	58	105	40	68.5	1917	1	
06 01 00 70	70	94	60	63	110	42	72.5	2210	1	
06 01 00 75	75	101	60	68	115	45	78.5	2525	1	
06 01 00 80	80	108	60	73	120	48	83.5	2865	1	

64 IN HEX sockets

DIN 7422, Chrome Alloy Steel, chrome plated.

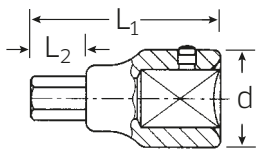

Code	mm	L ₁ mm	L ₂ mm	d mm	g	g
06 05 00 14	14	85	25	43	390	1
06 05 00 17	17	85	25	43	417	1
06 05 00 19	19	85	25	43	445	1
06 05 00 22	22	90	25	48	661	1
06 05 00 24	24	90	25	48	719	1
06 05 00 27	27	90	25	49	827	1

Drive tools and accessories

1" □, finish: Chrome Alloy Steel, chrome plated.

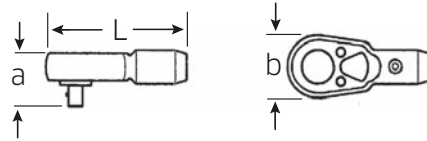

882 Ratchet



reversible, 36 teeth, with QuickRelease safety lock, without Bar handle No 888.



Code	L mm	b mm	a mm	g	g
16 11 00 00	185	70	60	1984	1

8820 Spare parts set for ratchet No 882

Content:

1 pinion, 1 pawl, 1 lever, 1 ball, 1 compression spring, 2 screws

Code	g	g
19 07 00 00	609	1

884 Flexible head



with QuickRelease safety lock, without Bar handle No 888.



Code	L mm	d mm	g	g
16 06 00 00	195	48	1848	1

886 Sliding head

without Bar handle No 888.



Code	L mm	d mm	g	g
16 07 00 00	80	48	616	1

888 Bar handle



Code	L mm	d mm	g	g
16 17 00 00	700	28	3337	1

859 Extensions

DIN 3123/ISO 3316.

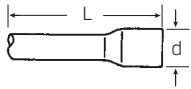

Code	size	L mm	d mm	$\Delta\Delta$ g	
16010001	8	200	43	1004	2
16010002	16	410	43	1794	2

866 Adaptor

HPQ

1" socket x 3/4" plug (25 x 20),
maximum torque 1412 N-m,
DIN 3123/ISO 3316, HPQ® high performance steel.



Code	L mm	d mm	$\Delta\Delta$ g	
16030005	70	43	347	2

60/6/6/882 Socket set 1"

in sturdy sheet steel case,
12 pieces
Content:
6 sockets with bi-hexagon No 60:
sizes 36; 41; 46; 50; 55; 60 mm
1 ratchet No 882
2 extensions No 859/8 (200 mm),
No 859/16 (410 mm)
1 flexible head No 884
1 sliding head for T-handle No 886
1 bar handle No 888



Code	$\Delta\Delta$ g
96060101	19720

60/8/6/882 Socket set 1"

in sturdy sheet steel case,
14 pieces
Content:
4 sockets with bi-hexagon No 60:
sizes 46; 50; 55; 60 mm
4 sockets with hexagon No 60:
sizes 65; 70; 75; 80 mm
1 ratchet No 882
2 extensions No 859/8 (200 mm), No 859/16 (410 mm)
1 flexible head No 884
1 sliding head for T-handle No 886
1 bar handle No 888



Code	$\Delta\Delta$ g
96060103	30000

440 CROW-RING spanners

AS
DRIVE

Caution! Modified settings on torque wrench (refer to note on page 187).
Chrome Alloy Steel, chrome plated.

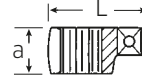
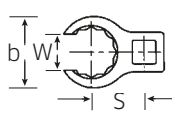

Code	Δ mm	Δ "	L mm	b mm	a mm	S mm	W mm	$\Delta\Delta$ g	
01 19 00 08	8	1/4	23.8	12.7	8	12.3	6.3	11	1
01 19 00 09	9	1/4	28.5	18.2	13.5	14	6.7	21	1
01 19 00 10	10¹⁾	1/4	28.4	18.2	13.5	14	7.1	16	1
01 19 00 11	11	1/4	28	18.2	13.5	14	8.6	17	1
01 19 00 12	12¹⁾	1/4	30.8	20.6	14	15.7	9	20	1
01 19 00 13	13	1/4	32	22.2	14	16.4	10	30	1
01 19 00 14	14¹⁾	1/4	31.7	22.2	14	16.4	11.1	20	1
02 19 00 15	15	3/8	36.5	24.6	17.5	19.1	11.9	34	1
02 19 00 16	16	3/8	36.1	24.6	17.5	19.1	13	27	1
02 19 00 17	17²⁾	3/8	39.2	27.3	17.5	20.5	14	40	1
02 19 00 18	18	3/8	40.8	29	18.5	21.3	14.8	45	1
02 19 00 19	19²⁾	3/8	40.5	29	18.5	21.3	15.8	40	1
02 19 00 20	20	3/8	42.9	31.3	18.5	22.5	15.8	54	1
02 19 00 21	21	3/8	42.8	31.3	18.5	22.5	16.2	45	1
02 19 00 22	22²⁾	3/8	45.3	33.5	19	23.6	17	57	1
02 19 00 23	23	3/8	47.5	35.7	19.5	24.6	17.5	71	1
02 19 00 24	24²⁾	3/8	47.3	35.7	19.5	24.6	18	57	1
02 19 00 25	25	3/8	49.3	37.7	20	25.7	19	80	1
02 19 00 26	26	3/8	49.3	37.7	20	25.7	19	63	1
02 19 00 27	27	3/8	52.8	40	21.4	28.2	20	100	1
02 19 10 27	27MB³⁾	3/8	57.1	42.1	15	29.3	20	92	1
03 19 00 28	28	1/2	56.8	42.1	22.5	29.3	21	120	1
03 19 00 30	30	1/2	63	48	22.5	32.5	22	155	1
03 19 00 32	32	1/2	62.5	48	22.5	32.5	24	145	1
03 19 00 34	34	1/2	64.2	50	24	33.5	27	146	1
03 19 00 36	36	1/2	66.5	51.9	24	34.6	27	150	1
03 19 00 38	38	1/2	68.1	53.9	24	35.6	28.6	147	1
03 19 00 40	40	1/2	71.8	57.9	24.5	37.7	31	160	1
03 19 00 41	41	1/2	71.8	57.9	24.5	37.7	31	169	1
03 19 00 42	42	1/2	71	57.9	24.5	37.7	33.2	189	1
03 19 00 46	46	1/2	77.7	64.2	26	40.9	34.1	215	1
03 19 00 50	50	1/2	83.2	70.5	27.5	44.1	39.7	295	1

¹⁾ For union nuts on fuel injection leads on 4-cylinder Mercedes-Benz diesel engines

²⁾ For use on suction or pressure lines within expansion valve of air conditioning unit (Mercedes-Benz)

³⁾ Slim-line version for setting of electronic injection on 440-HP-engines Mercedes-Benz series OM 442

Sockets, Socket Sets

6.3
1/4"

10
3/8"

12.5
1/2"

DIN
3120

ISO
1174-1

3

440a CROW-RING spanners

Code	⌀ "	⌀ "	L mm	b mm	a mm	S mm	W mm	Δ g	
01 49 00 24	3/8 1)	1/4	28.4	18.2	13.5	14	7.1	16	1
01 49 00 28	7/16	1/4	28	18.2	13.5	14	8.6	14	1
01 49 00 32	1/2	1/4	30.5	20.6	14	15.7	10	19	1
01 49 00 34	9/16	1/4	31.7	22.2	14	16.4	11.1	23	1
02 49 00 36	5/8	3/8	36.5	24.6	17.5	19.1	11.9	33	1
02 49 00 38	11/16	3/8	39.2	27.3	17.5	20.5	14	36	1
02 49 00 40	3/4	3/8	40.9	29	18.5	21.3	14.2	44	1
02 49 00 42	13/16	3/8	42.9	31.3	18.5	22.5	15.8	51	1
02 49 00 44	7/8	3/8	45.2	33.5	19	23.6	17.5	62	1
02 49 00 46	15/16	3/8	47.2	35.7	19.5	24.6	18.3	63	1
02 49 00 48	1	3/8	49.3	37.7	20	25.7	19	71	1
02 49 00 50	1 1/16	3/8	52.8	40	21.4	28.2	20	84	1
03 49 00 52	1 1/8	1/2	56.8	42.1	22.5	29.3	21	110	1
03 49 00 56	1 1/4	1/2	62.5	48	22.5	32.5	23.8	137	1
03 49 00 58	1 5/16	1/2	62.3	48	22.5	32.5	24.6	130	1
03 49 00 60	1 3/8	1/2	64.2	50	24	33.5	27	138	1
03 49 00 62	1 7/16	1/2	66.5	51.9	24	34.6	27	143	1
03 49 00 64	1 1/2	1/2	68.1	53.9	24	35.6	28.6	152	1
03 49 00 65	1 9/16	1/2	70.1	55.9	24	36.7	29.4	172	1
03 49 00 66	1 5/8	1/2	71.8	57.9	24.5	37.7	31	169	1
03 49 00 68	1 3/4	1/2	75.6	62	25.5	39.8	33.2	199	1
03 49 00 69	1 13/16	1/2	77.7	64.2	26	40.9	34.1	229	1
03 49 00 72	2	1/2	83.2	70.5	27.5	44.1	39.7	277	1
03 49 00 76	2 1/4	1/2	91.2	78.7	29.5	48.2	42.8	337	1
03 49 00 77	2 5/16	1/2	93.3	80.9	30	49.2	43.6	309	1
03 49 00 78	2 3/8	1/2	95.2	83	30.5	50.2	46	385	1

) For Volvo aero-engines, types "JAS"

440S MJ CROW-RING spanners

HPQ

Supersedes No 440 MJ
Caution! Modified settings on torque wrench (refer to note on page 187), EN 4108, for pipe unions with straight cylindrical involute toothing, HPQ® high performance steel, chrome plated.

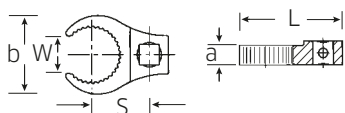

Code	Threaded nut	⌀ mm	⌀ "	L mm	b mm	a mm	S mm	W mm	Δ g	
01 21 10 10 MJ10	DN04	1/4	31.9	22	8	17	6.5	54	1	
01 21 10 14 MJ14	DN06	1/4	36.5	27	8	19.5	8.5	29	1	
02 21 10 16 MJ16	DN08	3/8	43.8	31	8	24	10.5	46	1	
02 21 10 18 MJ18	DN10	3/8	45.2	33	8	25	13	47	1	
02 21 10 20 MJ20	DN12	3/8	46.2	35	8	26	15	49	1	
02 21 10 22 MJ22	DN14	3/8	48.4	37	9	27	17.5	54	1	
02 21 10 24 MJ24	DN16	3/8	49.5	39	9	28	19.7	56	1	
02 21 10 27 MJ27	DN18	3/8	54.4	44	10	31	21.5	70	1	
02 21 10 30 MJ30	DN20	3/8	60.8	50	10	36	23.7	93	1	

540 CROW-RING spanners

Caution! Modified settings on torque wrench (refer to note on page 187), Chrome Alloy Steel, chrome plated.

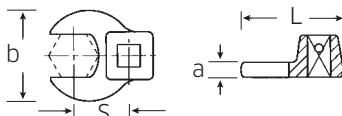

Code	⌀ mm	⌀ "	L mm	b mm	a mm	S mm	Δ g	
01 20 00 08	8	1/4	25.5	19.8	6.3	14.6	19	1
01 20 00 09	9	1/4	25.5	19.8	6.3	14.6	21	1
01 20 00 10	10	1/4	25.5	19.8	6.3	14.6	20	1
02 20 00 11	11	3/8	32	22.2	6.3	17.4	36	1
02 20 00 12	12	3/8	34.3	25.4	6.3	18.2	37	1
02 20 00 13	13	3/8	34.3	25.4	6.3	17.8	36	1
02 20 00 14	14	3/8	37.7	30	6.3	20.8	46	1
02 20 00 15	15	3/8	37.7	30	6.3	20.4	45	1
02 20 00 16	16	3/8	37.7	30	6.3	19.9	45	1
02 20 00 17	17	3/8	42.5	38	6.3	23.8	62	1
02 20 00 18	18	3/8	42.5	38	6.3	22.9	61	1
02 20 00 19	19	3/8	42.5	38	6.3	22.4	64	1
02 20 00 20	20	3/8	42.4	38	6.3	25	55	1
02 20 00 21	21	3/8	44.5	41	6.3	23.6	59	1
02 20 00 22	22	3/8	44.5	41	6.3	24.2	64	1
02 20 00 23	23	3/8	44.5	41	6.3	25.8	64	1
02 20 00 24	24	3/8	44.4	41	6.3	26.2	60	1
02 20 00 25	25	3/8	47	45	8	26.4	75	1
02 20 00 26	26	3/8	47	45	8	27.6	80	1
02 20 00 27	27	3/8	47	45	8	27.6	76	1
02 20 00 28	28	3/8	50	50	8	29.3	78	1
02 20 00 30	30	3/8	50	50	8	29.3	84	1
02 20 00 32	32	3/8	53	57	8	30.5	95	1
02 20 00 34	34	3/8	54.5	60	8	31.6	107	1
02 20 00 36	36	3/8	56.5	62	8	32.8	100	1
02 20 00 40	40	3/8	63	70	8	37.6	130	1
02 20 00 41	41	3/8	63	70	8	37.2	130	1
02 20 00 42	42	3/8	63	70	8	37.7	125	1
02 20 00 46	46	3/8	72	82	8	43.1	191	1
02 20 00 50	50	3/8	75	88	8	45.4	217	1

540a CROW-FOOT spanners

Code	⌀ "	⌀ "	L mm	b mm	a mm	S mm	Δ g	
01 50 00 24	3/8	1/4	25.5	19.8	6.3	14.6	17	1
02 50 00 28	7/16	3/8	32	22.2	6.3	17.2	34	1
02 50 00 32	1/2	3/8	34.3	25.4	6.3	18.1	37	1
02 50 00 34	9/16	3/8	37.7	30	6.3	20.9	40	1
02 50 00 36	5/8	3/8	37.7	30	6.3	20.4	44	1
02 50 00 38	11/16	3/8	42.5	38	6.3	24.1	62	1
02 50 00 40	3/4	3/8	42.5	38	6.3	24	66	1
02 50 00 42	13/16	3/8	42.3	38	6.3	24	59	1
02 50 00 44	7/8	3/8	44.5	41	6.3	25.8	65	1
02 50 00 48	1	3/8	47	45	8	26.7	78	1
02 50 00 50	1 1/16	3/8	47	45	8	27.2	78	1
02 50 00 52	1 1/8	3/8	50	50	8	28.5	84	1
02 50 00 54	1 3/16	3/8	50	50	8	29.2	83	1
02 50 00 56	1 1/4	3/8	53	57	8	30.3	101	1
02 50 00 58	1 5/16	3/8	53	57	8	31.2	101	1
02 50 00 60	1 3/8	3/8	54.5	60	8	32.3	105	1
02 50 00 62	1 7/16	3/8	56.5	62	8	33.1	107	1
02 50 00 64	1 1/2	3/8	58	65	8	34.5	118	1
02 50 00 65	1 9/16	3/8	59.5	68	8	35.7	126	1
02 50 00 66	1 5/8	3/8	63	70	8	37.3	140	1
02 50 00 67	1 11/16	3/8	63	70	8	37.7	126	1
02 50 00 68	1 3/4	3/8	68	76	8	40.4	161	1
02 50 00 70	1 7/8	3/8	72	82	8	42	205	1
02 50 00 72	2	3/8	75	88	8	44.8	214	1
02 50 00 74	2 1/8	3/8	75.6	91	10	46	265	1
02 50 00 76	2 1/4	3/8	80.5	96	10	49.5	297	1
03 50 00 78	2 3/8	1/2	81.5	96	8	51.3	214	1

540a HD CROW-FOOT spanners Heavy Duty

for particularly high loadings, e.g. stainless steel screw fittings.
Full use of jaws in conjunction with standard ratchets.
Caution! Modified settings on torque wrench (refer to note on page 187),
chrome plated. Supplied without ratchet.



Code	⌀	⌀	L mm	b mm	a mm	S mm	△ g	📦
02 50 10 24	NEW 3/8	3/8	39	26	11	24	58	1
02 50 10 28	NEW 7/16	3/8	40	26	11	25	58	1
02 50 10 32	NEW 1/2	3/8	42	30	11	25.8	67	1
02 50 10 34	9/16	3/8	43.4	32	11	26.8	52	1
02 50 10 36	5/8	3/8	45	34.8	11	27.7	58	1
02 50 10 38	11/16	3/8	47.2	38	11	28.6	69	1
02 50 10 40	NEW 3/4	3/8	49	41	11	29.6	96	1
02 50 10 42	13/16	3/8	51	46.4	11	30.5	113	1
02 50 10 44	7/8	3/8	52	48	11	31.3	99	1
02 50 10 46	15/16	3/8	54	51.2	11	32.3	129	1
02 50 10 48	1	3/8	56	53.4	11	33.2	133	1
02 50 10 50	1 1/16	3/8	57	53.8	11	34.1	124	1
02 50 10 52	1 1/8	3/8	59	53.8	11	35	128	1
02 50 10 54	NEW 1 3/16	3/8	60	56	11	35.9	148	1
02 50 10 56	1 1/4	3/8	62	60	11	36.8	153	1
02 50 10 58	NEW 1 5/16	3/8	63	56	11	27.9	160	1
02 50 10 60	NEW 1 3/8	3/8	65	62	11	38.7	180	1
02 50 10 62	1 7/16	3/8	66.5	66	11	39.6	172	1
03 50 10 64	1 1/2	1/2	76	70	16	45	310	1
03 50 10 69	1 13/16	1/2	85	84	16	49.6	400	1
03 50 10 72	2	1/2	89	90	16	52.3	451	1
03 50 10 74	2 1/8	1/2	91.5	92.8	16	54.2	460	1
03 50 10 75	2 3/16	1/2	93	96	16	55.1	480	1
03 50 10 76	2 1/4	1/2	95	99	16	56	500	1



1225 Special extension

3/8" ■, offset



Code	L mm	d mm	△ g	📦
12 25 00 01	150	17	128	5

447 Adaptor

AS DRIVE HPQ

Caution! Modified settings on torque wrench (refer to note on page 187),
American sizes: SAE AS 954-E, HPQ® high performance steel, gunmetal
finish.

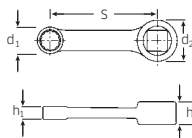

Code	⌀ mm	⌀ "	d ₁ mm	d ₂ mm	h ₁ mm	h ₂ mm	S mm	△ g	📦
02 18 10 07	7	3/8	11.5	19	6	11	50.8	30	1
02 18 10 08	8	3/8	12.4	19	6	11	50.8	30	1
02 18 10 09	9	3/8	14	19	8	11	50.8	40	1
02 18 10 10	10	3/8	15.6	19	8	11	50.8	40	1
02 18 10 13	13	3/8	19.3	19	9.2	11	50.8	55	1

447a Adaptor

Code	⌀ "	⌀ "	d ₁ mm	d ₂ mm	h ₁ mm	h ₂ mm	S mm	△ g	📦
02 47 00 16	1/4	3/8	10.4	19	6	11	50.8	27	1
02 47 00 20	5/16	3/8	12.4	19	6	11	50.8	29	1
02 47 00 24	3/8	3/8	14.9	19	8	11	50.8	41	1
02 47 00 28	7/16	3/8	17	19	8	11	50.8	40	1
02 47 00 32	1/2	3/8	19	19	9.2	11	50.8	56	1
02 47 00 34	9/16	3/8	21	19	9.2	11	50.8	61	1
02 47 00 36	5/8	3/8	23	19	12	11	50.8	73	1

447aSP Spline-Drive-Adapter

HPQ

Caution! Modified settings on torque wrench (refer to note on page 187),
MS-33787, MIL-W-8982, HPQ® high performance steel, gunmetal finish.

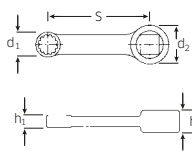

Code	Spline size	⌀ "	⌀ "	d ₁ mm	d ₂ mm	h ₁ mm	h ₂ mm	S mm	△ g	📦
02 48 00 14	7	3/8	7/32	9.4	19	6	11	50.8	28	1
02 48 00 16	8	3/8	1/4	10.4	19	6	11	50.8	27	1
02 48 00 18	9	3/8	9/32	11.5	19	6	11	50.8	29	1
02 48 00 20	10	3/8	5/16	12.4	19	6	11	50.8	29	1
02 48 00 24	12	3/8	3/8	14.9	19	8	11	50.8	38	1
02 48 00 28	14	3/8	7/16	17	19	9.2	11	50.8	39	1
02 48 00 32	16	3/8	1/2	19	19	9.2	11	50.8	59	1
02 48 00 34	18	3/8	9/16	21	19	9.2	11	50.8	55	1
02 48 00 36	20	3/8	5/8	23	19	12	11	50.8	74	1

10
3/8"

12.5
1/2"

DIN
3120

ISO
1174-1

3

Empty boxes and trays

No	Box No	mm	Box Code	Tray Code	No	Box No	mm	Box Code	Tray Code
40/9/4, 40D/9/4	40/9KN	227x131x57	81 25 10 19	83 01 30 12*	45a/22/8QR	50/4KN	454x253x64	81 27 10 34	83 02 21 12*
40/13/6	40/9KN	227x131x57	81 25 10 19	83 01 20 80*	45a/33/13	50/5	530x265x50	81 27 00 05	83 02 02 13
40/13/6QR	40/9KN	227x131x57	81 25 10 19	83 01 21 82*	52/9/3	50/3KN	413x226x64	81 27 10 13	83 03 14 25*
40/44/17/5	40/9KN	227x131x57	81 25 10 19	83 01 20 81*	50/12/3, 52/12/3	50/3KN	413x226x64	81 27 10 13	83 03 14 12*
40/44/17/5QR	40/9KN	227x131x57	81 25 10 19	83 02 20 84*	54/10	40/9KN	227x131x57	81 25 10 19	83 03 24 03*
40/23/7, 40D/23/7	45/1KN	322x134x57	81 26 10 11	83 01 20 17*	54/12	45/1KN	322x134x57	81 26 10 11	83 03 44 09*
40/23/6N, 40D/23/6	40/9KN	227x131x57	81 25 10 19	83 01 20 14*	54CV/9	40/9KN	227x131x57	81 25 10 19	83 03 34 09*
40/24/6	40/9KN	227x131x57	81 25 10 19	83 01 20 82*	3054X/54X/8	40/9KN	227x131x57	81 25 10 19	83 03 36 12*
40/24/6QR	40/9KN	227x131x57	81 25 10 19	83 01 20 83*	54/8/4	40/7KN	413x230x57	81 25 10 14	83 03 34 13*
40ma/25/8	45/1KN	322x134x57	81 26 10 11	83 01 20 35*	52/16/5	50/4KN	454x253x64	81 27 10 34	83 03 54 09*
40/45/36/12	40/7KN	413x230x57	81 25 10 14	83 01 20 10*	50/16/6, 52/16/6	50/4KN	454x253x64	81 27 10 34	83 03 24 80*
40/52/27/11	50/4KN	454x253x64	81 27 10 34	83 01 20 04* 83 01 20 05*	52/16/6QR	50/4KN	454x253x64	81 27 10 34	83 03 24 81*
40TX/44KTX/15/6	40/9KN	227x131x57	81 25 10 19	83 01 20 07*	50/22/6, 52/22/6	50/4KN	454x253x64	81 27 10 34	83 03 14 07*
88TX	45/1KN	322x134x57	81 26 10 11	83 02 20 17*	50ma/39/6N	50/5	530x265x50	81 27 00 05	83 03 14 26
89TX	40/7KN	413x230x57	81 25 10 14	83 09 20 13*	50/54/25/6, 52/54/25/6	50/4KN	454x253x64	81 27 10 34	83 03 24 17*
86TX	50/6KN	481x288x82	81 27 10 19	83 01 20 02* 83 01 10 03*	50/43/7	50/5	530x265x50	81 27 00 05	83 03 05 11
40a/9/4, 40aD/9/4	40/9KN	227x131x57	81 25 10 19	83 01 20 13*	87, 876	50/6KN	481x288x82	81 27 10 19	83 09 31 11* 83 09 32 11*
40aD/12/7QR	40/9KN	227x131x57	81 25 10 19	83 01 21 16*	50TX/7	-	-	-	83 06 00 09
40aD/30/7QR	40/7KN	413x230x57	81 25 10 14	83 01 21 12*	50TX/8	40/9KN	227x131x57	81 25 10 19	83 03 34 11*
40aD/8/1H	40/9KN	227x131x57	81 25 10 19	83 01 21 07*	54TX/9	-	-	-	83 06 00 10
4008/27/1R	45/1KN	322x134x57	81 26 10 11	83 18 10 01*	54TX/10	40/9KN	227x131x57	81 25 10 19	83 03 24 02*
45/11/4, 456/11/4	45/1KN	322x134x57	81 26 10 11	83 02 20 13*	54TX/59TX/12/1	40/7KN	413x230x57	81 25 10 14	83 06 10 12*
45/14/5i, 456/14/5i	45/1KN	322x134x57	81 26 10 11	83 02 20 80*	54TXB/9	-	-	-	83 06 00 10
45/14/5iQR	45/1KN	322x134x57	81 26 10 11	83 02 20 81*	54TXB/10	40/9KN	227x131x57	81 25 10 19	83 03 24 02*
45/13/5, 456/13/5	45/1KN	322x134x57	81 26 10 11	83 02 20 45*	50TX/16/5	50/3KN	413x226x64	81 27 10 13	83 03 24 13*
45ma/28/5	40/7KN	413x230x57	81 25 10 14	83 02 20 27*	876TX	50/6KN	481x288x82	81 27 10 19	83 09 20 11*
45/49/19/5, 456/49/19/5	40/7KN	413x230x57	81 25 10 14	83 02 20 21*	50a/17/6	50/4KN	454x253x64	81 27 10 34	83 03 14 41*
89	50/6KN	481x288x82	81 27 10 19	83 02 11 18*	87a	50/6KN	481x288x82	81 27 10 19	83 09 11 12* 83 09 12 12*
45/41/9	50/5	530x265x50	81 27 00 05	83 02 02 02	55/10/6	55/7	575x220x86	81 29 00 08	83 04 00 02
45TX/7	-	-	-	83 06 00 15	55/9/6N	55/7	575x220x86	81 29 00 08	83 04 00 01
49TX/8	-	-	-	83 06 00 14	55a/10/5	55/6	520x160x86	81 29 00 07	83 04 00 03
45TX/49TX/15/5	40/7KN	413x230x57	81 25 10 14	83 02 20 19*	55a/16/6	55/7	575x220x86	81 29 00 08	83 04 00 04
45/49/32/5TX	40/7KN	413x230x57	81 25 10 14	83 02 20 09*	60/6/6/882	60/1	785x173x90	81 30 00 01	-
45a/12/5	45/1KN	322x134x57	81 26 10 11	83 02 20 06*	60/8/6/882	60/2	785x200x122	81 30 00 02	-
45a/14/8QR	50/4KN	454x253x64	81 27 10 34	83 02 20 12*	12171/19/4 VDE 12179/9/4 VDE	50/6KN VDE	481x288x82	81 27 20 19	-

*The code numbers of these inlays are applicable only to the new plastic cases.

 Made in
Germany



Do you need empty cases?

If so, include the appropriate hard-foam inlays from STAHLWILLE in your order. Together with the new tool cases, they ensure an exact fit and, as a result, excellent protection for your tools.



4 | IMPACT SOCKETS, BITS

IMPACT SOCKETS, ADAPTORS AND SETS
→ PAGE 156



BITS AND ACCESSORY TOOLS
→ PAGE 164



IMPACT DRIVER AND SET
→ PAGE 172





IMPACT Sockets, Machine actuated. **STAHLWILLE IMPACT**

1

Tried-and-tested components for professional use in conjunction with compressed air and electric power and impact screwdrivers. All the tools in the IMPACT product range have been designed for particularly heavy-duty work on a day-to-day basis. Used as additional tools in conjunction with power impact tools they feature extremely good load-bearing capacity and very long lifetimes. The name IMPACT is a by-word in all fields of industry and the trades for leading-edge quality made by professionals for professionals.

2

STAHLWILLE IMPACT sockets are extraordinarily tough. Their remarkable fitting accuracy, which is due to very tight tolerances, guarantees minimum loss of force as the impact is transferred from the impact screwdriver to the socket insert and also dramatically improved durability.

3

STAHLWILLE IMPACT sockets are made from high-grade Chrome Alloy Steel. They are hardened in an oil bath to ensure they are normalised and non-warping, making them extremely accurate tools with very close tolerances.

4

IMPACT quality is available individually or in sets

Whatever else the professional might want in a tool, there is no compromising on the quality. The extensions, adaptors, joints and sockets will always fit - perfectly. Combine them as you need them. Slot them together. Done.

5

Joints

- 1 Deep groove for O-ring to improve grip and
- 2 straight-through central bore for locking pin.
- 3 Bevelled edge facilitates attachment and ensures optimum contact with the wrench. No mechanical loading on the retainer pin.
- 4 Recessed keyway adaptors with spring-loaded pins on the square drive, e.g. No 3116, 3216.





4

No 2309K
 e.g. 1/2" wheel nut socket (sizes 17; 19 and 21 mm)
 with plastic sleeves, specially for sensitive alloy wheels.

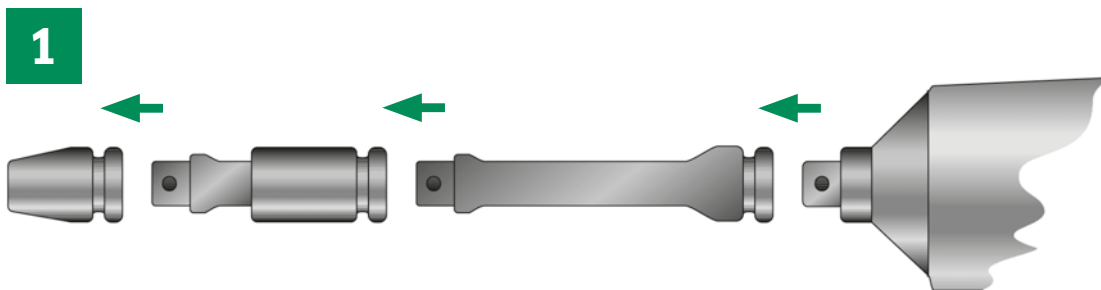

STAHlwILLE IMPACT sockets



STAHlwILLE IMPACT sockets



No 50IMP/6/2

12.5
1/2"

IMPACT sockets

1/2" -drive

DIN
3121

50IMP IMPACT sockets

1/2" -drive, DIN 3129/ISO 1711-2, for power drivers, Chrome Alloy Steel, gunmetal finish.

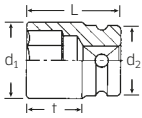

Code	mm	d ₁ mm	d ₂ mm	L mm	t mm	Δ g	
23010008	8	14.3	25	38	21.5	86	10
23010010	10	16.8	25	38	21.5	89	10
23010011	11	18.1	25	38	21.5	88	10
23010012	12	19.5	25	38	21.5	89	10
23010013	13	20.8	25	38	21.5	85	10
23010014	14	22.1	25	38	21.5	86	10
23010015	15	23.5	30	38	23	132	10
23010016	16	24.8	30	38	23	130	10
23010017	17	26.2	30	38	22.9	132	10
23010018	18	27.5	30	38	22.6	130	10
23010019	19	28.8	30	40	24.6	133	10
23010021	21	31.3	30	40	23	135	10
23010022	22	32.5	30	42	25	141	10
23010023	23	33.8	30	40	24.5	150	5
23010024	24	35	30	44	28	164	5
23010025	25	36.3	30	44	25	170	5
23010027	27	38.8	30	45	29	190	5
23010030	30	42	30	50	34	199	5
23010032	32	44	30	50	34	210	5

50IMP/6/2 IMPACT set

8 pieces

Content:

6 Sockets No 50IMP:

sizes 13; 17; 19; 21; 22; 24 mm

1 Extension No 509/5IMP

1 Universal Joint No 510IMP for power drivers

1 each rubber ring No 5091/1 IMP, 5091/2 IMP

1 each connecting pin No 5092/1 IMP, 5092/2 IMP



Code	Δ g
96231101	1800

50D IMP IMPACT sockets

1/2" -drive, DIN 3129/ISO 1711-2, for power drivers, Chrome Alloy Steel, gunmetal finish.



Code	mm	d ₁ mm	d ₂ mm	L mm	t mm	Δ g	
23011032	32	44	30	50	27	251	1
23011036	36	49	35	50	28.5	313	1

51IMP IMPACT sockets

1/2" -drive, ISO 1711-2, for power drivers, extra deep, Chrome Alloy Steel, gunmetal finish.

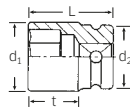

Code	mm	d ₁ mm	d ₂ mm	L mm	t mm	Δ g	
23020013	13	20.8	25	85	68.5	222	5
23020015	15	23.5	30	85	68	340	5
23020016	16	24.8	30	85	68	338	5
23020017	17	26.2	30	85	68	318	5
23020018	18	27.5	30	85	68	309	5
23020019	19	28.8	30	85	67.5	292	5
23020021	21	31.3	30	85	66.5	291	5
23020022	22	32.5	30	85	66.5	323	5
23020024	24	35	30	85	66	335	5
23020027	27	38.8	30	85	65	385	5

TCS 50IMP/51IMP/19

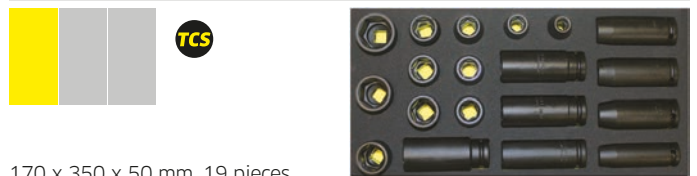

170 x 350 x 50 mm, 19 pieces

Code	Δ g
96838777	3960
No 50IMP	1/2" sizes 10; 13; 15; 16; 17; 18; 19; 21; 22; 24; 27 mm
No 51IMP	1/2" sizes 13; 15; 17; 18; 19; 21; 22; 24 mm

TCS 50IMP/19/2

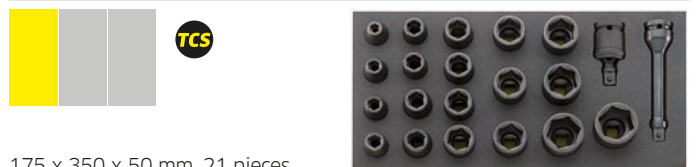

175 x 350 x 50 mm, 21 pieces

Code	Δ g
96838791	3055
No 50IMP	sizes 8; 10; 11; 12; 13; 14; 15; 16; 17; 18; 19; 21; 22; 23; 24; 25; 27; 30; 32 mm
No 509/5IMP	1/2" 125 mm
No 510IMP	1/2" 68 mm

TCS 54IMP/2307TX/15

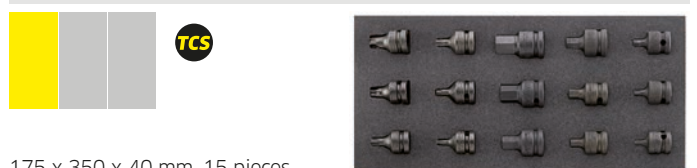

175 x 350 x 40 mm, 15 pieces

Code	Δ g
96838792	1285
No 54IMP	1/2" sizes 5; 6; 7; 8; 10; 12; 14; 17; 19 mm
No 2307TX	1/2" size T30; T40; T45; T50; T55; T60

2309 ○ IMPACT sockets

1/2" ○-drive, for power drivers, extra deep, with reduced outside diameter, Chrome Alloy Steel, gunmetal finish.

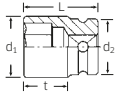

Code	mm	d ₁ mm	d ₂ mm	L mm	t mm	g	Box
23090017	17	25.7	30	85	68.0	242	5
23090019	19	28.2	30	85	67.5	257	5
23090221 NEW	21	30.7	30	85	66.5	272	5
23090022	22	32.0	30	85	66.5	311	5

for wheel nuts

ES 2309/4



175 x 175 x 40 mm, 4 pieces

Code	g
96838162	1145



No 2309

1/2" ○ sizes 17; 19; 21; 22 mm

83812080	Empty tray	55
----------	------------	----

2309K ○ Wheel nut sockets

1/2" ○-drive, with plastic sleeve. Sleeve extension protects not only wheel bolts and nuts but also the wheel and holes.



Code	mm	L mm	∅ mm	g	Box
23091017	17	86	27	242	1
23091019	19	86	29	250	1
23091221 NEW	21	86	31	265	1

ES 2309K/3

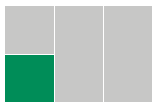

175 x 175 x 40 mm, 3 pieces

Code	g
96838260	800



No 2309K

1/2" ○ sizes 17; 19; 21 mm

83812080	Empty tray	55
----------	------------	----

54IMP ○ IMPACT INHEX sockets

1/2" ○-drive, for hexagon socket head screws, for power drivers, Chrome Alloy Steel, gunmetal finish.

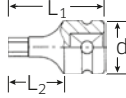

Code	mm	L ₁ mm	L ₂ mm	d mm	g	Box
23050005	5	38	15	25	58	5
23050006	6	38	15	25	59	5
23050007	7	38	15	25	60	5
23050008	8	38	15	25	61	5
23050010	10	40	17	25	67	5
23050012	12	42	19	30	111	5
23050014	14	43	20	30	118	5
23050017	17	45	22	30	134	5
23050019	19	50	27	30	164	5

54IMP/9 IMPACT set INHEX sockets

9 pieces

Content:

sizes 5; 6; 7; 8; 10; 12; 14; 17;

19 mm

1 each rubber ring No 5091/1 IMP, 5091/2 IMP

1 each connecting pin No 5092/1 IMP, 5092/2 IMP



Code	g
96231501	1370

2308TX ○ IMPACT sockets

1/2" ○-drive, external TORX®, for power drivers, Chrome Alloy Steel, gunmetal finish.

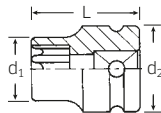

Code	size	mm	d ₁ mm	d ₂ mm	L mm	g	Box
23080010	E10	9.4	14	25	38	67	10
23080012	E12	11.1	15.9	25	38	73	10
23080014	E14	12.9	17.7	25	38	73	10
23080016	E16	14.7	20	25	38	77	10
23080018	E18	16.6	22	30	38	115	10
23080020	E20	18.4	24.5	30	38	120	10
23080024	E24	22.1	30	30	41.2	149	10

2307TX ○ IMPACT sockets

1/2" ○-drive, inside TORX®, for power drivers, Chrome Alloy Steel, gunmetal finish.

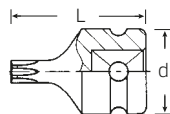

Code	size	mm	d mm	L mm	g	Box
23070030	T30	5.5	25	40	57	5
23070040	T40	6.6	25	40	58	5
23070045	T45	7.8	25	40	59	5
23070050	T50	8.8	25	40	57	5
23070055	T55	11.2	25	40	61	5
23070060	T60	13.2	25	40	66	5

12.5
1/2"

DIN
3121

ISO
1174-2

4

12.5
1/2"

Accessory tools for IMPACT sockets

1/2" square drive
outside E 12.5, inside G 12.5
Finish: Chrome Alloy Steel, gunmetal finish

20
3/4"

DIN
3121

ISO
1174-2

509IMP Extensions



Code	size	L mm	d mm	g	
33010001	2	52	30	151	5
33010002	5	130	30	271	5
33010003	10	255	30	452	5

510IMP Universal joint



Code	L mm	d mm	g	
33020000	52	32	228	5

513IMP Adaptor



Code	inside		L mm	d mm	g	
	"	"				
33030002	1/2	3/8	37	30	109	5

514IMP Adaptor



Code	inside		L mm	d mm	g	
	"	"				
33030005	1/2	3/4	49	30	174	5

5091 Rubber rings

Code	size	g	
39011940	1IMP ¹⁾	1	10
39012440	2IMP ²⁾	1	10

¹⁾ for Socket sizes 8-14 mm, TORX® size E10-E16, size T30-T60
²⁾ for Socket sizes 15-32 mm, TORX® size E18-E24 and accessories

5092 Connecting pins

Code	size	g	
39022030	1IMP ¹⁾	1	10
39022530	2IMP ²⁾	2	10

¹⁾ for Socket sizes 8-14 mm, TORX® size E10-E16, size T30-T60
²⁾ for Socket sizes 15-32 mm, TORX® size E18-E24 and accessories

IMPACT sockets

3/4" -drive

55IMP IMPACT sockets

3/4" -drive DIN 3129/ISO 1711-2, for power drivers, Chrome Alloy Steel, gunmetal finish.

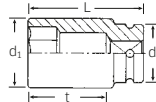

Code	mm	d ₁ mm	d ₂ mm	L mm	t mm	g	
25010017	17	29	44	48	23	365	5
25010018	18	30.5	44	48	23	345	5
25010019	19	32	44	48	23	359	5
25010021	21	35	44	50	25	375	5
25010022	22	36.5	44	50	25	377	5
25010024	24	39.5	44	50	24.5	382	5
25010027	27	43.5	44	51	24.5	387	5
25010028	28	45	44	54	27	417	5
25010029	29	46	44	54	26.5	425	5
25010030	30	47.4	44	54	26.5	438	2
25010032	32	49.9	44	54	26	456	2
25010033	33	51.5	44	54	25.5	477	2
25010034	34	52.4	44	54	29	490	2
25010036	36	54.9	44	57	32	545	2
25010038	38	58	44	58	33	592	2
25010041	41	57	44	59	34	746	1
25010046	46	67	44	64	36.5	746	1

56IMP IMPACT sockets

3/4" -drive, ISO 1711-2, for power drivers, extra deep, Chrome Alloy Steel, gunmetal finish.

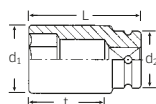

Code	mm	d ₁ mm	d ₂ mm	L mm	t mm	g	
25020017	17	32	44	100	75	783	2
25020019	19	32	44	100	75	779	2
25020021	21	35	44	100	75	864	2
25020022	22	36.5	44	100	75	854	2
25020024	24	39.5	44	100	74.5	838	2
25020027	27	43.5	44	100	72.5	800	2
25020030	30	47.4	44	100	72.5	860	2
25020032	32	49.9	44	100	72	922	2
25020034	34	52.4	44	100	71.5	983	2
25020036	36	54.9	44	100	71	1038	2
25020041	41	57	44	100	75	899	1
25020046	46	67	44	100	75	1427	1

2509 IMPACT sockets

3/4" -drive, for power drivers, extra deep, with reduced diameter, Chrome Alloy Steel, gunmetal finish.

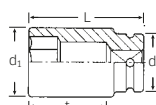

Code	mm	d ₁ mm	d ₂ mm	L mm	t mm	g	
25090027	27	40.5	44	100	72.5	672	2
25090030	30	44.3	44	100	72.5	728	2
25090032	32	46.8	44	100	72	778	2
25090033	33	48	44	100	72	803	2

for Trilux wheels

Accessory tools for IMPACT sockets

3/4" square drive
 outside F 20, inside H 20
 Finish: Chrome Alloy Steel, gunmetal finish

560IMP Extensions



Code	size	L mm	d mm	g	
35 01 00 01	7	180	44	805	5
35 01 00 02	10	250	44	1051	5
35 01 00 03	13	330	44	1305	5

561IMP Universal joint



Code	L mm	d mm	g	
35 02 00 00	99	44	657	2

568IMP Adaptor



Code	inside "	outside "	L mm	d mm	g	
35 03 00 03	3/4	1/2	56	44	335	5

569IMP Adaptor



Code	inside "	outside "	L mm	d mm	g	
35 03 00 06	3/4	1	65	44	477	5

5591IMP Rubber ring

Code	g	
39 01 36 50	3	10

for sockets and accessories

5592IMP Connecting pin

Code	g	
39 02 35 40	3	10

for sockets and accessories

IMPACT sockets

1" -drive

60IMP IMPACT sockets

1" -Antrieb, DIN 3129/ISO 1711-2, für Kraftschrauber,
 Chrome-Alloy-Steel, brüniert.

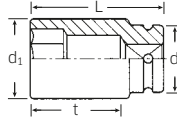

Code	mm	d ₁ mm	d ₂ mm	L mm	t mm	g	
26 01 00 24	24	41.5	54	58	28	638	2
26 01 00 27	27	45	54	60	30	654	2
26 01 00 30	30	49	54	62	32	688	2
26 01 00 32	32	51.5	54	63	32	694	2
26 01 00 33	33	52.5	54	63	31.5	692	2
26 01 00 36	36	56.5	54	67	34.5	754	2
26 01 00 38	38	59	54	70	37	836	2
26 01 00 41	41	63	54	70	36.5	892	2
26 01 00 42	42	64.5	54	73	39	970	1
26 01 00 46	46	69.5	54	76	41	1106	1
26 01 00 50	50	74.5	54	82	52	1362	1
26 01 00 55	55	81	54	87	57	1669	1
26 01 00 60	60	87	54	91	61	1960	1
26 01 00 65	65	92	54	85	55	1678	1
26 01 00 70	70	96	54	88	58	1803	1
26 01 00 75	75	100	86	92	62	2674	1
26 01 00 80	80	105	86	97	67	2949	1

66IMP IMPACT sockets

1" -drive, ISO 1711-2, for power drivers, extra deep, Chrome Alloy Steel,
 gunmetal finish.

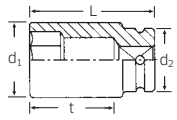

Code	mm	d ₁ mm	d ₂ mm	L mm	t mm	g	
26 02 00 24	24	41.5	54	110	80	1431	2
26 02 00 27	27	45	54	110	80	1393	2
26 02 00 30	30	49	54	110	79.5	1338	2
26 02 00 32	32	51.5	54	110	79	1296	2
26 02 00 33	33	52.5	54	110	78.5	1274	2
26 02 00 36	36	56.5	54	110	78	1312	2
26 02 00 38	38	59	54	110	77	1355	2
26 02 00 41	41	63	54	110	76	1504	2
26 02 00 46	46	69.5	54	110	72	1711	2

2609 IMPACT sockets

1" -drive, for power drivers, extra deep, with reduced outside diameter,
 Chrome Alloy Steel, gunmetal finish.

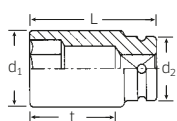

Code	mm	d ₁ mm	d ₂ mm	L mm	t mm	g	
26 09 00 27	27	42.3	54	110	80	1001	2
26 09 00 30	30	46	54	110	79.5	1047	2
26 09 00 32	32	48.5	54	110	79	1015	2
26 09 00 33	33	49.8	54	110	78.5	1102	2

for wheel nuts

20
3/4"

25
1"

DIN
3121

ISO
1174-2

4

IMPACT-Tools

25
1"

Accessory tools for IMPACT sockets

1"  square drive
outside  F 25, inside  H 25
Finish: Chrome Alloy Steel, gunmetal finish

40
1 1/2"

DIN
3121

ISO
1174-2

859IMP Extensions



Code	size	L mm	d mm	Δ g	
36010001	7	180	54	1361	2
36010002	13	330	54	2168	2



871IMP Universal joint



Code	L mm	d mm	Δ g	
36020000	125	54	1244	1



865IMP Adaptor



Code	inside  "	outside  "	L mm	d mm	Δ g	
36030007	1	1 1/2	85	54	986	1

866IMP Adaptor



Code	inside  "	outside  "	L mm	d mm	Δ g	
36030005	1	3/4	70	54	565	2

6091IMP Rubber ring

Code	Δ g	
39014850	8	10

for sockets up to size 70 mm and accessories

6092IMP Connecting pin

Code	Δ g	
39025050	7	10

for sockets up to size 70 mm and accessories



IMPACT sockets

1 1/2" -drive

70IMP IMPACT sockets

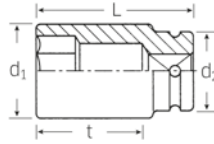
1 1/2" -drive, DIN 3129, for power drivers,
Chrome Alloy Steel, gunmetal finish.





Code	 mm	d ₁ mm	d ₂ mm	L mm	t mm	Δ g	
27010055	55	86	86	89	42	2482	1
27010060	60	92	86	92	50	2743	1
27010065	65	100	86	96	54	3249	1
27010070	70	105	86	101	59	3541	1
27010075	75	109	86	105	63	3746	1
27010080	80	115	86	110	68	4162	1
27010085	85	121	86	116	74	4661	1
27010090	90	130	86	118	76	5382	1
27010095	95	135	127	118	76	7500	1
27010100	100	140	127	125	83	8000	1
27010105	105	150	127	125	83	9000	1
27010110	110	155	127	137	95	10500	1
27010115	115	160	127	137	95	10500	1
27010120	120	165	127	145	103	12000	1

Accessory tools for IMPACT sockets

1 1/2"  square drive
outside  F 40, inside  H 40
Finish: Chrome Alloy Steel, gunmetal finish

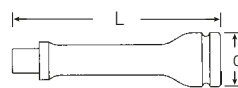
759IMP Extensions



Code	size	L mm	d mm	Δ g	
37010001	10	254	86	5500	2
37010002	13	330	86	7000	1
37010003	15	381	86	8000	1

771IMP Universal joint



Code	L mm	d mm	Δ g	
37020000	125	86	4197	1

768IMP Adaptor



Code	inside ○"	outside ■"	L mm	d mm	△ g	☐
37030006	1 1/2	2 1/2	100	90	3142	1

867IMP Adaptor



Code	inside ○"	outside ■"	L mm	d mm	△ g	☐
36030006	1 1/2	1	95	86	2180	1

also for MULTIPOWER No MP300-5000 (page 223)

7091 Rubber rings

Code	size	△ g	☐
39013870	1IMP¹⁾	15	1
39013875	2IMP²⁾	38	1

¹⁾ for Socket sizes 70IMP 55-90 mm, 60IMP sizes 75 and 80 mm and accessories
²⁾ for Socket sizes 95-120 mm

7092 Connecting pins

Code	size	△ g	☐
39023870	1IMP¹⁾	16	1
39023875	2IMP²⁾	25	1

¹⁾ for Socket sizes 70IMP 55-90 mm, 60IMP sizes 75 and 80 mm and accessories

²⁾ for Socket sizes 95-120 mm

IMPACT sockets

2 1/2" ○-drive

80IMP ○ IMPACT sockets

2 1/2" ○-drive, DIN 3129, for power drivers, Chrome Alloy Steel, gunmetal finish.

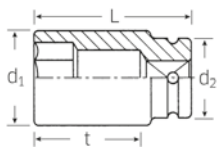

Code	○ mm	d ₁ mm	d ₂ mm	L mm	t mm	△ g	☐
28010075	75	115	127	125	67	7500	1
28010080	80	115	127	125	67	7000	1
28010085	85	127	127	130	67	7490	1
28010090	90	135	127	132	74	8000	1
28010095	95	140	127	132	74	8000	1
28010100	100	145	127	141	83	9000	1
28010105	105	150	127	141	83	9000	1
28010110	110	160	127	150	92	11000	1
28010115	115	165	127	150	92	11000	1
28010120	120	170	127	158	100	12000	1

Accessory tools for IMPACT sockets

2 1/2" ○ square drive

outside ■ F 63, inside ○ H 63

Finish: Chrome Alloy Steel, gunmetal finish

860IMP Extensions

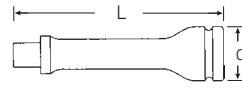

Code	size	L mm	d mm	△ g	☐
38010001	12	305	127	16000	1
38010002	18	457	127	22000	1
38010003	24	610	127	28500	1

868IMP Adaptor



Code	inside ○"	outside ■"	L mm	d mm	△ g	☐
38030005	2 1/2	1 1/2	138	127	7000	1

8091/1IMP Rubber ring

Code	△ g	☐
39016395	37	10

for sockets and accessories

8092/1IMP Connecting pin

Code	△ g	☐
39026397	42	1

for sockets and accessories



40
1 1/2"

63
2 1/2"

DIN
3121

ISO
1174-2

4



IMPACT Sockets, Machine actuated. **STAHLWILLE range of BITS**

1

STAHLWILLE range of BITS - uncompromisingly attractive.

Reliable screwdriver inserts and adaptors in individual sizes or as sets for power screwdrivers or manual use.

2

The bit that fits - always

That is why STAHLWILLE offers such a range of BITS for flat-bladed, Phillips®, POZIDRIV/SUPADRIV®, internal TORX®, TORX PLUS®, internal serration, internal hex drive, TRI-WING®, TORQ-SET® screws and recessed 5-star screws with a central pin - if required, also available in sets with corresponding tightening tools e.g. anticlockwise and clockwise ratcheting bit-holder. High-grade special steel alloys and special hardening processes guarantee optimum torquing and long service lifetimes.

3

Get a grip on it: sturdy bit-holders and ratchets etc.

STAHLWILLE BITS are, of course, also suitable for manual use, e.g. in conjunction with the corresponding bit-holders, ratchets, magazine holders, switchable ratchets and TORSIOMAX torque screwdrivers.



No 4008/27/1R

1



4

2



Slotted



Phillips-Recess®



POZIDRIV®
SUPADRIV®

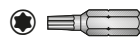

Internal TORX®



Internal TORX®
with hollow point

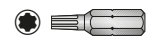

TORX PLUS®

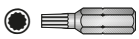

Internal serration
XZN®



Internal hex



TRI-WING®



TORQ-SET®



5-star
with hollow point

3



BITS screwdriver inserts from STAHLWILLE guarantee minimum transmission losses.



STAHLWILLE BITS are also suitable for use with heavy-duty power screwdrivers.



e.g. bit holder No 4000 for BITS screwdriver inserts with external 1/4" hex



e.g. ratchet No 415SGB N with 1/4" internal hex drive, reversible

BITS

1218-1223 1231-1234

⊕ BITS

DIN 3128, for Phillips screws.



Code	No	Phillips-Recess®	outside ●	"	L mm	△ g	☐
08000000	1218	000	C 4	-	28	3	5
08000001	1219	00	C 4	-	28	3	5
08010000	1220	0	C 6.3	1/4	25	5	10
08010001	1221	1	C 6.3	1/4	25	5	10
08010002	1222	2	C 6.3	1/4	25	5	10
08010003	1223	3	C 6.3	1/4	25	5	10
08030001	1231	1	C 8	5/16	32	9	10
08030002	1232	2	C 8	5/16	32	10	10
08030003	1233	3	C 8	5/16	32	10	10
08030004	1234	4	C 8	5/16	32	12	10

outside ● DIN 3126/ISO 1173

Phillips-Recess® DIN 5260

extra hard for self tapping and other hardened screws.

PZ1221-1223

⊕ BITS

for POZIDRIV/SUPADRIV® screws, extra hard.



Code	No	POZIDRIV/ SUPADRIV®	outside ●	"	L mm	△ g	☐
08050001	PZ1221	1	C 6.3	1/4	25	5	10
08050002	PZ1222	2	C 6.3	1/4	25	5	10
08050003	PZ1223	3	C 6.3	1/4	25	6	10

outside ● DIN 3126/ISO 1173

1157-1169

⊖ BITS

DIN 3127/ISO 2351, for slotted screws.



Code	No	a x b mm	outside ●	"	L mm	△ g	☐
08070017	1157	0.25 x 1.5	C 4	-	28	3	5
08070018	1158	0.4 x 2.0	C 4	-	28	3	5
08070019	1159	0.4 x 2.5	C 4	-	28	3	5
08070120	1160	0.5 x 3.0	C 6.3	1/4	25	5	10
08070121	1161	0.5 x 4.0	C 6.3	1/4	25	6	10
08070122	1162	0.6 x 3.5	C 6.3	1/4	25	6	10
08070123	1163	0.6 x 4.5	C 6.3	1/4	25	6	10
08070124	1164	0.8 x 4.0	C 6.3	1/4	25	6	10
08070125	1165	0.8 x 5.5	C 6.3	1/4	25	7	10
08070126	1166	1.0 x 5.5	C 6.3	1/4	25	8	10
08070130	1166/1	1.2 x 6.5	C 6.3	1/4	25	9	10
08070127	1167	1.2 x 8.0	C 6.3	1/4	25	12	10
08070128	1168	1.6 x 8.0	C 6.3	1/4	25	12	10
08070129	1169	1.6 x 10.0	C 6.3	1/4	25	16	10

outside ● DIN 3126/ISO 1173

1350-1360

⊙ BITS

for tri-square socket head screws (XZN®).



Code	No	size	outside ●	"	L mm	△ g	☐
08200004	1350	M4	C 6.3	1/4	25	4	10
08200010	1356	M5	C 6.3	1/4	25	5	10
08200011	1357	M6	C 6.3	1/4	25	5	10
08200012	1358	M8	C 8	5/16	28	10	10
08200013	1359	M10	C 8	5/16	38	15	10
08200014	1360	M12	C 8	5/16	38	20	10

outside ● DIN 3126/ISO 1173

DIN 65254 (M4, M5, M6)

Application: No 1350, size M4, for door lock attachment on the Audi TT, VW Golf, Bora, Passat B5, Lupo, New Beetle

1407-1421 1430-1435

⊙ BITS

for inside TORX® screws



Code	No	size	mm	outside ●	"	L mm	△ g	☐
08130003	1407	T 3	1.1	C 4	-	28	3	5
08130004	1408	T 4	1.3	C 4	-	28	3	5
08130005	1409	T 5	1.3	C 4	-	28	3	5
08130006	1410	T 6	1.6	C 6.3	1/4	25	5	10
08130007	1411	T 7	2.0	C 6.3	1/4	25	5	10
08130008	1412	T 8	2.3	C 6.3	1/4	25	5	10
08130009	1413	T 9	2.5	C 6.3	1/4	25	5	10
08130010	1414	T 10	2.7	C 6.3	1/4	25	5	10
08130015	1415	T 15	3.3	C 6.3	1/4	25	5	10
08130020	1416	T 20	3.8	C 6.3	1/4	25	5	10
08130025	1417	T 25	4.4	C 6.3	1/4	25	6	10
08130027	1418	T 27	5.0	C 6.3	1/4	25	6	10
08130030	1419	T 30	5.5	C 6.3	1/4	25	6	10
08130040	1420	T 40	6.6	C 6.3	1/4	25	7	10
08130045	1421	T 45	7.8	C 6.3	1/4	25	8	10
08140027	1430	T 27	5.0	C 8	5/16	35	11	10
08140030	1431	T 30	5.5	C 8	5/16	35	11	10
08140040	1432	T 40	6.6	C 8	5/16	35	12	10
08140045	1433	T 45	7.8	C 8	5/16	35	14	10
08140050	1434	T 50	8.8	C 8	5/16	35	14	10
08140055	1435	T 55	11.2	C 8	5/16	35	20	10

outside ● DIN 3126/ISO 1173

Application: No 1416, size T20, for the door handle attachment for Mercedes-Benz types 168 and 203

No 1421, size T45, for removing and refitting the front doors on the VW Golf III and Vento from model year 93 on

No 1435, size T55, for screws in rear seats of BMW X6 Model E71, 7 series Model F01/F02

1440-1446

⊙ BITS

with hollow point for inside TORX® screws (TORX® TAMPER RESISTANT).



Code	No	size	mm	outside ●	"	L mm	△ g	☐
08160010	1440	T 10	2.7	C 6.3	1/4	26	6	10
08160015	1441	T 15	3.3	C 6.3	1/4	26	6	10
08160020	1442	T 20	3.8	C 6.3	1/4	26	6	10
08160025	1443	T 25	4.4	C 6.3	1/4	26	6	10
08160027	1444	T 27	5.0	C 6.3	1/4	26	6	10
08160030	1445	T 30	5.5	C 6.3	1/4	26	6	10
08160040	1446	T 40	6.6	C 6.3	1/4	26	6	10

outside ● DIN 3126/ISO 1173

1427 BITS

for inside TORX® screws.



Code	size	outside mm	"	L mm	 g	
08 13 10 25	T 25	C 6.3	1/4	65	18	1

For BMW series 3 and 5
outside DIN 3126/ISO 1173

1436 IP- 1446 IP BITS

for inside TORX PLUS® screws.



Code	No	outside mm	"	L mm	 g	
08 16 20 06	1436 IP 6	C 6.3	1/4	25	5	10
08 16 20 07	1437 IP 7	C 6.3	1/4	25	4	10
08 16 20 08	1438 IP 8	C 6.3	1/4	25	4	10
08 16 20 09	1439 IP 9	C 6.3	1/4	25	4	10
08 16 20 10	1440 IP 10	C 6.3	1/4	25	4	10
08 16 20 15	1441 IP 15	C 6.3	1/4	25	5	10
08 16 20 20	1442 IP 20	C 6.3	1/4	25	5	10
08 16 20 25	1443 IP 25	C 6.3	1/4	25	5	10
08 16 20 27	1444 IP 27	C 6.3	1/4	25	5	10
08 16 20 30	1445 IP 30	C 6.3	1/4	25	6	10
08 16 20 40	1446 IP 40	C 6.3	1/4	25	6	10

1440 TPI- 1446 TPI 5-star BITS

with hollow point,
for female 5-star screws with
a centring pin.



Code	No	outside mm	"	L mm	 g	
08 16 10 10	1440 TPI 10	C 6.3	1/4	26	6	5
08 16 10 15	1441 TPI 15	C 6.3	1/4	26	5	5
08 16 10 20	1442 TPI 20	C 6.3	1/4	26	5	5
08 16 10 25	1443 TPI 25	C 6.3	1/4	26	5	5
08 16 10 27	1444 TPI 27	C 6.3	1/4	26	5	5
08 16 10 30	1445 TPI 30	C 6.3	1/4	26	5	5
08 16 10 40	1446 TPI 40	C 6.3	1/4	26	7	5

outside DIN 3126/ISO 1173

1204/8 5-star BITS set

Storage facility for BITS screwdriver
inserts.

Content:

- 1 bit-holder No 412
- 7 BITS screwdriver inserts for
female 5-star screws with centring pin,
sizes TPI 10, 15, 20, 25, 27, 30, 40.

For generators, motor management units,
airflow sensors, door trim, immobilisers
and injection pumps
(e.g. Ford, Mercedes-Benz cars & HGVs,
Rover, Volvo, VW/Audi).



Code	 g	
96 08 11 13	87	1

1300-1304 BITS

DIN 7426/ISO 3109,
for socket head screws, extra hard.



Code	No	mm	outside mm	"	L mm	 g	
08 09 00 03	1300	3	C 6.3	1/4	25	4	10
08 09 00 04	1301	4	C 6.3	1/4	25	5	10
08 09 00 05	1302	5	C 6.3	1/4	25	6	10
08 09 00 06	1303	6	C 6.3	1/4	25	6	10
08 09 00 08	1304	8	C 6.3	1/4	30	11	10

outside DIN 3126/ISO 1173

1299 BITS

for inside hexagon screws,
for operating the adjusting
screws on torque wrenches
No 720, 721, 730 and 730N.



Code	mm	outside mm	"	L mm	 g	
08 09 00 02	2	C 6.3	1/4	34	4	10

outside DIN 3126/ISO 1173

13008 BITS

for TRI-WING® screws.



Code	TRI- WING®	outside mm	"	L mm	 g	
08 25 00 00	0	C 6.3	1/4	25	5	10
08 25 00 01	1	C 6.3	1/4	25	5	10
08 25 00 02	2	C 6.3	1/4	25	5	10
08 25 00 03	3	C 6.3	1/4	25	5	10
08 25 00 04	4	C 6.3	1/4	25	5	10
08 25 00 05	5	C 6.3	1/4	25	5	10
08 25 00 06	6	C 6.3	1/4	25	8	10

outside DIN 3126/ISO 1173

13010 BITS

for TORQ-SET® screws.



Code	TORQ- SET®	outside mm	"	L mm	 g	
08 26 00 00	0	C 6.3	1/4	25	5	10
08 26 00 01	1	C 6.3	1/4	25	5	10
08 26 00 02	2	C 6.3	1/4	25	5	10
08 26 00 03	3	C 6.3	1/4	25	5	10
08 26 00 04	4	C 6.3	1/4	25	5	10
08 26 00 05	5	C 6.3	1/4	25	5	10
08 26 00 06	6	C 6.3	1/4	25	5	10
08 26 00 08	8	C 6.3	1/4	25	5	10
08 26 00 10	10	C 6.3	1/4	25	5	10
08 26 00 16	1/4 A	C 8	5/16	32	11	10
08 26 00 20	5/16 A	C 8	5/16	32	11	10
08 26 00 24	3/8 A	C 8	5/16	32	11	10

outside DIN 3126/ISO 1173

BITS und accessories

1201 BITS Box

Storage box with screwdriver bits.
Content:

- 1 magnetic bit-holder
- ⊕ 3 Bits, sizes 1; 2; 3 for Phillips screws
- ⊕ 3 Bits, sizes 1; 2; 3 for POZIDRIV/SUPADRIV® screws
- ⊖ 3 Bits, sizes 0.6 x 4.5; 0.8 x 5.5; 1.2 x 6.5 mm; for slotted screws
- ⊗ 6 Bits, size T10; size T15; size T20; size T25; size T30; size T40; for inside TORX® screws (TORX® TAMPER RESISTANT)
- 3 Bits, sizes 4; 5; 6 mm; for inside hexagon screws



Code	g	g	g
96080102	190	1	

1204/21-1 BITS Box

Storage box with screwdriver bits.
Content:

- 1 magnetic bit-holder
- ⊕ 4 Bits, sizes 1; 2 (2x); 3 for Phillips screws
- ⊕ 4 Bits, sizes 1; 2 (2x); 3 for POZIDRIV/SUPADRIV® screws
- ⊗ 9 Bits, sizes T10; T15; T20 (2x); T25 (2x); T27; T30; T40; for inside TORX® screws
- 3 Bits, sizes 4; 5; 6 mm; for inside hexagon screws



Code	g	g	g
96080121	185	1	

1204/21-2 BITS Box

Storage box with screwdriver bits.
Content:

- 1 magnetic bit-holder
- ⊕ 3 Bits, sizes 1; 2; 3 for Phillips screws
- ⊖ 4 Bits, sizes 0.5 x 4.0; 0.6 x 4.5; 0.8 x 5.5; 1.2 x 6.5 mm; for slotted screws
- ⊗ 6 Bits, sizes T10; T15; T20; T25; T30; T40; for inside TORX® screws
- 3 Bits, sizes 4; 5; 6 mm; for inside hexagon screws
- ⊕ 4 Bits, sizes 4; 6; 8; 10 mm; for TORQ-SET® screws



Code	g	g	g
96080122	181	1	

4000 Spinner handles

for BITS screwdriver bits with outside hexagon 1/4" DIN 3126/ISO 1173 C 6.3, handle of impact proof plastic. Internal hex drive with a collar-thrust spring.

Bits are easy to insert, lock securely in position and can be removed just as easily; even hex bits with a wide groove (Type E, DIN 3126/ISO 1173).

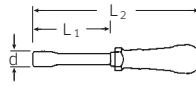

Code	inside	"	d	L ₁	L ₂	g	g
18073026	D 6.3	1/4	11	75	190	119	5

inside ○ DIN 3126/ISO 1173

4006/1 Spinner with magazine holder

for 6 BITS screwdriver bits (25 mm) with 1/4" outer hexagon, DIN 3126/ISO 1173 C 6.3, transparent plastic handle for storing BITS with rotating selection cap, internal hexagon and powerful permanent magnet.



Code	inside	"	d	L ₁	L ₂	g	g
18080017	D 6.3	1/4	10	120	230	124	1

inside ○ DIN 3126/ISO 1173

12504 BIT holder

for BITS screwdriver bits with outside hexagon 1/4" DIN 3126/ISO 1173 C 6.3, flexible shaft, handle of impact proof plastic.



Code	inside	"	L ₁	L ₂	g	g
18103016	D 6.3	1/4	175	290	168	10

inside ○ DIN 3126/ISO 1173

12503 BIT holder

for BITS screwdriver bits with outside hexagon 1/4" DIN 3126/ISO 1173 C 6.3, inside hexagon with magnet, stubby version, handle of impact proof plastic.



Code	inside	"	L ₁	L ₂	g	g
18110016	D 6.3	1/4	10	65	50	10

inside ○ DIN 3126/ISO 1173

4007 BIT holder

for BITS screwdriver bits with outside hexagon 1/4" DIN 3126/ISO 1173 C 6.3, inside hexagon with magnet, with T-handle.



Code	inside ○	"	d mm	L ₁ mm	L ₂ mm	△ g	
18 09 00 16	D 6.3	1/4	10	200	165	108	5

inside ○ DIN 3126/ISO 1173

415B BIT ratchet

reversible, 22 teeth, with 2-component handle and inside hexagon, 1/4", DIN 3126/ISO 1173 D 6.3 for BITS Screwdriver sockets 1/4". Internal hex drive with a collar-thrust spring (registered design). Bits are easy to insert, lock securely in position and can be removed just as easily; even hex bits with a wide groove (Type E, DIN 3126/ISO 1173).



Code	L mm	b mm	a mm	△ g	
11 13 10 10	117	22	12	76	5

415SGB N BIT ratchet

F&D

reversible, 80 teeth, with steel handle and inside hexagon, 1/4", DIN 3126/ISO 1173 D 6.3 for Bits Screwdriver sockets 1/4". Internal hex drive with a collar-thrust spring. Bits are easy to insert, lock securely in position and can be removed just as easily; even hex bits with a wide groove (Type E, DIN 3126/ISO 1173), for use in confined spaces, re-engages after movement of 4.5°, construction without screws prevents foreign object damage.



NEW

Code	L mm	b mm	a mm	△ g	
11 13 20 20	117	22.6	10.7	85	1

25B Ratcheting BIT holder

for hexagon BITS, magnetic location, reversible heads angled, chrome plated.



Code	inside ○	"	L mm	d ₁ mm	d ₂ mm	a ₁ mm	a ₂ mm	△ g	
41 54 16 20	1/4 x 5/16		138	20	23	15	17	105	1

4008 Ratcheting BIT holder

- Easy change of direction (anticlockwise, clockwise and fixed) by simply twisting the locking ring
- Ergonomically designed, non-slip 2-component handle for optimum force transmission
- Storage compartment for 6 bits in the handle; push button to open (Size 1)
- For BITS screwdriver inserts with external hex 1/4" DIN 3126/ISO 1173 Type C 6.3
- 1/4" sockets can be used with Adaptor No 3115/1 (external hex and square drive 1/4")
- Easy bit change thanks to internal hex. drive with magnet
- Knurled spin section for faster screw advance
- Heavy-duty mechanism with 48 teeth (7.5° working angle)

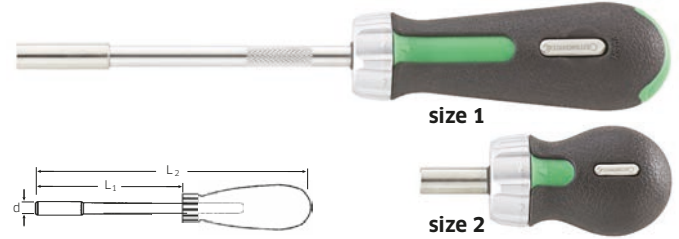

Code	size	inside ○	"	L ₁ mm	L ₂ mm	d mm	△ g	
18 12 00 01	1	D 6.3	1/4	127	250	10	248	1
18 12 00 02	2	D 6.3	1/4	25	95	10	137	1

inside ○ DIN 3126/ISO 1173

4008/27/1R Ratcheting BIT holder set



29 pieces

Content:

- 1 Ratcheting bit holder No 4008-1
- 3 Bits ⊕ 1221; 1222; 1223
- 3 Bits ⊕ PZ 1221; PZ 1222; PZ 1223
- 6 Bits ⊕ 1440 T10; 1441 T15; 1442 T20; 1443 T25; 1445 T30; 1446 T40
- 3 Bits ⊖ 1301; 1302; 1303
- 3 Bits ⊖ 1163 0.6 x 4.5; 1165 0.8 x 5.5; 1166/1 1.2 x 6.5 mm
- 1 Square drive extension No 3115/1 with 1/4" outer hex. and outer square drives for attaching 1/4" □ sockets
- 9 Sockets No 40, 1/4" □ sizes 4; 5; 5.5; 6; 7; 8; 10; 11; 13 mm

Code	△ g	
96 18 22 03	1025	1

3115/2 BIT holder

for torque screwdrivers No 760 and No 775, inside hexagon DIN 3126 D4 for BITS screwdriver bits C4, outside hexagon 1/4" DIN 3126/ISO 1173 E 6.3.



Code	inside ○	outside ●	"	L mm	△ g	
31 15 00 03	4 mm	E 6.3	1/4	60	18	1

outside ● DIN 3126/ISO 1173

BITS und accessories

1200/1 BIT holder

with permanent magnet 1/4" inside and outside hexagon 1/4" DIN 3126/ISO 1173 C 6.3.



Code	inside ○	"	outside ●	"	L mm	Δ	g	
38 12 0001	D 6.3	1/4	E 6.3	1/4	72	37	5	

inside ○/outside ● DIN 3126/ISO 1173

3825/1 Quick-change holder

for BITS screwdriver bits with 1/4" external hexagonal drive DIN 3126/ISO 1173 C 6.3, with quick-action chuck, adaptor with external hexagonal drive for powered use.



Code	inside ○	"	outside ●	"	L mm	Δ	g	
38 25 0002	D 6.3	1/4	E 6.3	1/4	62	27	1	

inside ○/outside ● DIN 3126/ISO 1173

3115 Adaptor, manually operated

for torque screwdrivers No 760 and No 775, for manually operated sockets with recessed 6.3 (1/4") square drive DIN 3120/ISO 1174-1 Type C and D, square drive with ball bearing, Chrome Alloy Steel, gunmetal finish.



Code	outside ■	"	outside ●	"	L mm	d mm	Δ	g	
31 15 0001	A 6.3	1/4	E 6.3	1/4	50	8.9	16	5	

outside ■ DIN 3120/ISO 1174-1 Type A (spring-loaded ball)

outside ● DIN 3126/ISO 1173 Type E

3115/1 Adaptor, manually operated

for manually operated sockets with recessed 6.3 (1/4") square drive DIN 3120/ISO 1174-1 Type C and D, square drive with ball bearing, Chrome Alloy Steel.



Code	outside ■	"	outside ●	"	L mm	Δ	g	
31 15 0002	A 6.3	1/4	C 6.3	1/4	25	10	5	

outside ■ DIN 3120/ISO 1174-1 Type A (spring-loaded ball)

outside ● DIN 3126/ISO 1173 Type C

3116/1-3316/1 Adaptor, machine operated

DIN 7428/ISO 3317, with outside hexagon for power operated IMPACT sockets DIN 3129/ISO 2725-2 with inside square DIN 3121/ISO 1174-2, Large collar diameter for better support of IMPACT sockets (3216/1, 3316/1), Square drive with spring loaded locking pin, Chrome Alloy Steel, gunmetal finish.

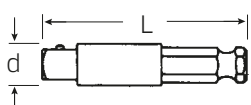

Code	No	outside ■	"	outside ●	"	L mm	d mm	Δ	g	
31 16 0001	3116/1	E 6.3	1/4	E 6.3	1/4	50	8.9	16	5	
32 16 0001	3216/1	E 10	3/8	E 6.3	1/4	50	15.5	23	5	
33 16 0001	3316/1	E 12.5	1/2	E 6.3	1/4	50	18	34	5	

outside ■ DIN 3121/ISO 1174-2 Type E (spring-loaded locking pin)

outside ● DIN 3126/ISO 1173 Type E

3116/1QR-3316/1QR QuickRelease Adaptor, machine operated

NEW

QR

with outside hexagon for power operated IMPACT sockets DIN 3129/ISO 2725-2 with inside square DIN 3121/ISO 1174-2, Large collar diameter for better support of IMPACT sockets (3216/1, 3316/1), Chrome Alloy Steel, gunmetal finish.

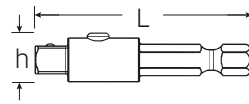

Code	No	outside ■	"	outside ●	"	L mm	h mm	Δ	g	
31 16 1001	3116/1QR	E 6.3	1/4	E 6.3	1/4	50	11.2	18	5	
32 16 1001	3216/1QR	E 10	3/8	E 6.3	1/4	50	14.6	27	5	
33 16 1001	3316/1QR	E 12.5	1/2	E 6.3	1/4	55	19.2	48	5	

outside ● DIN 3126/ISO 1173 Type E

412/442/443/543 BIT holder

square drive socket, for hand use only, for BITS-Screwdriver bits with outside hexagon 1/4" or 5/16" DIN 3126/ISO 1173 C 6.3 or C 8, Chrome Alloy Steel, chrome plated. Internal hex drive with a collar-thrust spring (registered design). Bits are easy to insert, lock securely in position and can be removed just as easily; even hex bits with a wide groove (Type E, DIN 3126/ISO 1173).



Code	No	inside ○	"	inside ○	"	L mm	d mm	Δ	g	
11 18 00 10	412	D 6.3	1/4	C 6.3	1/4	25	11.6	15	5	
12 18 00 26	442	D 6.3	1/4	C 10	3/8	32	16.5	30	5	
12 18 00 30	443	D 8	5/16	C 10	3/8	32	16.5	39	5	
13 18 00 10	543	D 8	5/16	C 12.5	1/2	38	22	65	5	

inside ○ DIN 3126/ISO 1173

inside ○ DIN 3120/ISO 1174-1

412-1 BIT holder

○ 1/4" inside hexagon, DIN 3126/ISO 1173 D 6.3. Outer ● 10 mm for use in tools with 10 mm internal hex drive or internal double hexagon (e.g. "FLEXI" double-ended flexi-joint spanners, T-handle universal joint spanners, box spanners, ratchet ring spanners etc.).

Internal hex drive with a collar-thrust spring. Bits are easy to insert, lock securely in position and can be removed just as easily; even hex bits with a wide groove (Type E, DIN 3126/ISO 1173).



Code	outside ●	L mm	d mm	Δ	g	
11 18 00 20	10 mm	20	11.6	11	5	

736 BIT holder insert tools

Internal hex drive with a collar-thrust spring. Bits are easy to insert, lock securely in position and can be removed just as easily; even hex bits with a wide groove (Type E, DIN 3126/ISO 1173).



Code	size	inside D	"	mm	b mm	h mm	S mm	g
58 26 10 10	10	D 8	5/16	9x12	16	12.5	17.5	47
58 26 26 10	10-1	D 6.3	1/4	9x12	14	10	17.5	45

inside DIN 3126/ISO 1173

BITS screwdrivers

with outside hexagon DIN 3126/ISO 1173, shape E 6.3 (1/4"), for use in power drivers.

1242-1250 BITS screwdrivers

DIN 3127/ISO 2351, for slotted screws.



Code	No	a x b mm	outside mm	"	L mm	g
08 30 06 35	1242	0.6 x 3.5	E 6.3	1/4	50	8
08 30 08 40	1244	0.8 x 4.0	E 6.3	1/4	50	9
08 30 10 55	1246	1.0 x 5.5	E 6.3	1/4	50	10
08 30 12 65	1248	1.2 x 6.5	E 6.3	1/4	50	12
08 30 16 80	1250	1.6 x 8.0	E 6.3	1/4	50	14

outside DIN 3126/ISO 1173

1260-1262 BITS screwdrivers

DIN 3128, for Phillips screws.



Code	No	Phillips-Recess®	outside mm	"	L mm	g
08 31 00 01	1260	1	E 6.3	1/4	50	10
08 31 00 02	1261	2	E 6.3	1/4	50	11
08 31 00 03	1262	3	E 6.3	1/4	50	11

outside DIN 3126/ISO 1173

Phillips-Recess® DIN 5260

1270-1272 BITS screwdrivers

for POZIDRIV/SUPADRIV® screws.



Code	No	POZIDRIV/ SUPADRIV®	outside mm	"	L mm	g
08 32 00 01	1270	1	E 6.3	1/4	50	10
08 32 00 02	1271	2	E 6.3	1/4	50	11
08 32 00 03	1272	3	E 6.3	1/4	50	11

outside DIN 3126/ISO 1173

1280-1284 BITS screwdrivers

DIN 7426/ISO 3109, for socket head screws.



Code	No	mm	outside mm	"	L mm	g
08 33 00 03	1280	3	E 6.3	1/4	50	9
08 33 00 04	1281	4	E 6.3	1/4	50	10
08 33 00 05	1282	5	E 6.3	1/4	50	12
08 33 00 06	1283	6	E 6.3	1/4	50	13
08 33 00 08	1284	8	E 6.3	1/4	50	18

outside DIN 3126/ISO 1173

1290-1296 BITS screwdrivers

for inside TORX® screws.



Code	No	size	outside mm	"	L mm	g
08 34 00 10	1290	T 10	E 6.3	1/4	70	14
08 34 00 15	1291	T 15	E 6.3	1/4	70	14
08 34 00 20	1292	T 20	E 6.3	1/4	70	14
08 34 00 25	1293	T 25	E 6.3	1/4	70	15
08 34 00 27	1294	T 27	E 6.3	1/4	70	16
08 34 00 30	1295	T 30	E 6.3	1/4	70	16
08 34 00 40	1296	T 40	E 6.3	1/4	70	18

outside DIN 3126/ISO 1173

1441 TN-1446 TN Torsion BITS screwdrivers

for inside TORX® screws.

- specifically developed for use with professional battery-powered impact screwdrivers.
- longer service lifetimes thanks to specially designed torsional shape, flexible material and high-grade hardening.
- controlled machine handling close to the screw thanks to very compact construction.



Code	No	size	outside mm	"	L mm	g
08 16 11 15	1441 TN 15	T 15	E 6.3	1/4	38	5
08 16 11 20	1442 TN 20	T 20	E 6.3	1/4	38	5
08 16 11 25	1443 TN 25	T 25	E 6.3	1/4	38	6
08 16 11 30	1445 TN 30	T 30	E 6.3	1/4	38	7
08 16 11 40	1446 TN 40	T 40	E 6.3	1/4	38	8

outside DIN 3126/ISO 1173

2801 Sockets

with hexagon inserts for power drivers, hexagon fitted with permanent magnet, Chrome Alloy Steel, clear lacquered.



Code	mm	outside mm	"	d mm	L mm	g
2801 10 07	7	E 6.3	1/4	12	50	23
2801 10 08	8	E 6.3	1/4	13	50	26
2801 10 10	10	E 6.3	1/4	15.5	50	31
2801 10 13	13	E 6.3	1/4	18.7	50	44

BITS und accessories

13006 Special socket

for use on plugs in electronic rack
Airbus A320-A340.



Code	outside ● "	"	∅ mm	L mm	⚖ g	📦
08 23 00 01	E 6.3	1/4	11	50	32	10

outside ● DIN 3126/ISO 1173

4060 IMPACT driver set

for screw sizes M5-M10,
in strong metal case.
Content:



- 1 each IMPACT driver No 4030
- Adaptors No 4035; No 4036
- ⊖ BITS screwdrivers for slotted screws No 4040-4044
- ⊕ BITS screwdrivers for Phillips-screws No 4050-4052
- BITS screwdrivers for Hex. Socket Head screws No 4055-4058

Code	⚖ g	📦
96 32 30 01	1410	1

4030 IMPACT driver

with inside hexagon for
BITS screwdriver inserts
No 4040-4058, suitable for
screws
M 5-M 10, torque 120 N·m.



Code	inside ○ "	L mm	⚖ g	📦
32 20 00 05	3/8	138	617	1

4035/4036 Adaptors

with outside hexagon,
for IMPACT screwdriver No 4030.

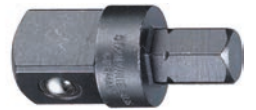

Code	No	outside ● "	outside ■ "	L mm	⚖ g	📦
32 21 00 01	4035	3/8	3/8	38	34	1
33 21 00 01	4036	3/8	1/2	38	43	1

4040-4044 ⊖ BITS screwdrivers

for slotted screws,
for IMPACT driver No 4030.



Code	No	a x b mm	outside ● "	L mm	⚖ g	📦
08 40 00 10	4040	1.0 x 7	3/8	40	17	10
08 40 00 14	4041	1.4 x 9	3/8	40	19	10
08 40 00 16	4042	1.6 x 10	3/8	40	21	10
08 40 00 20	4043	2.0 x 12	3/8	40	20	10
08 40 00 15	4044	1.5 x 13	3/8	40	24	10

4050-4052 ⊕ BITS screwdrivers

for Phillips screws,
for IMPACT driver No 4030.



Code	No	Phillips- Recess®	outside ● "	L mm	⚖ g	📦
08 41 00 02	4050	2	3/8	35	17	10
08 41 00 03	4051	3	3/8	35	17	10
08 41 00 04	4052	4	3/8	35	17	10

Phillips-Recess® DIN 5260

4055-4058 ● BITS screwdrivers

for socket head screws,
for IMPACT driver No 4030.



Code	No	mm	outside ● "	L mm	⚖ g	📦
08 42 00 05	4055	5	3/8	35	16	10
08 42 00 06	4056	6	3/8	35	16	10
08 42 00 08	4057	8	3/8	35	19	10
08 42 00 10	4058	10	3/8	35	23	10





5 | TORQUE TOOLS, TORQUE TESTERS

TORQUE SCREWDRIVERS

→ PAGE 179



TORQUE WRENCHES, MECHANICAL

→ PAGE 180



ANGLE-CONTROLLED TORQUE WRENCHES, ELECTRONIC

→ PAGE 194



ACCESSORIES TORQUE WRENCHES

→ PAGE 208



INSERT/SHELL TOOLS

→ PAGE 209



TORQUE MULTIPLIERS MULTIPOWER

→ PAGE 218



SPARE PARTS

→ PAGE 219



TORQUE TESTER

→ PAGE 221



CALIBRATION SYSTEMS

→ PAGE 224



ACCESSORIES TORQUE TESTER AND CALIBRATION SYSTEMS

→ PAGE 232



Overview of torquing tools

What type of tool do you need?

To ensure safety and productivity, STAHLWILLE torquing tools offer you a high degree of convenience, accurate setting and optimised ergonomic designs. The following overview is designed to help you select just the right model for your application.

1 Torque screwdrivers



for example, the TORSIOMETER 760

Torque screwdrivers				
click-type	indicating	No	Capacity	Page
	•	760	15-600 cN·m	179
•		775	2-1000 cN·m	179

2 Torque wrenches



for example, the MANOSKOP® 730 Quick

Torque wrenches				
click-type	indicating	No	Capacity	Page
	•	71	160-800 N·m	180
	•	73Nm/15	2-15 N·m	180
•		755	1,5-300 N·m	181
•		730	4-40 N·m	184
•		730 Quick	6-650 N·m	184
•		730/80	160-800 N·m	184
•		721 Quick	6-300 N·m	185
•		720Nf	160-800 N·m	186
•		721Nf	160-1000 N·m	186
•		730N	2-1000 N·m	188-190
•		730 Fix	10-1000 N·m	191
	•	701	1-20 N·m	192-193
	•	712R/6	3-60 N·m	206

3 Angle-controlled/torque wrenches



for example, the Sensortork® 713R

Torque wrench/angle-controlled wrench				
click-type	indicating	No	Capacity	Page
•	•	730D	10-1000 N·m	196-198
•	•	714	1-1000 N·m	200-203
	•	713R	3-400 N·m	204-206



STAHLWILLE's calibration laboratory - accredited from the highest instance.

Controlled bolt tightening is an essential aspect of operating safety and the durability of screws and bolts. Put your trust in STAHLWILLE's DAkkS calibration laboratory. For all your torquing tools and testers.

More details on page 178.

4 Insert tools



Insert tools		
System		Page
9x12 mm	9x12	209 - 211
14x18 mm	14x18	212 - 213
22x28 mm	22x28	214
24,5x28 mm	24,5x28	215

5 Torque multipliers



MULTIPOWER		
No	Capacity	Page
MP300	800-5000 N·m	218
MP100-1500	100-1500 N·m	218

6 Reference technique



Torque testers and calibrating units		
No	Capacity	Page
SmartCheck	1-800 N·m	221
7707 W Torque tester	0,2-1100 N·m	222
7791 / 7792 Manutork	1-3000 N·m	224 - 227
7794 perfectControl	1-1000 N·m	229 - 231
Accessories		232 - 233

STAHLWILLE's calibration laboratory - accredited from the highest instance

5



Controlled tightening is a must in terms of safety and the lifetimes of the screws and bolts. STAHLWILLE has been awarded accreditation as a calibrating laboratory for torque by the German Accreditation Body (DAkkS) because of the Company's skills in the field of torque controlled tightening.



The STAHLWILLE calibration service is in a position to offer both the usual **works calibration certificate** and the **DAkkS certificate**.

Torque screwdrivers

TORSIOMETER 760

- indicating type
- the measuring element is a torsional leaf spring
- clockwise tightening (with trailing pointer) and anticlockwise tightening
- with 1/4" internal hex drive (F 6.3 DIN 3126)
- comparative scale in in·lb and cursor
- inserts and adaptors with external hex E 6.3 (1/4")

- DIN 3126/ISO 1173 are securely held and firmly controlled in the mounting shaft (for BITS screwdriver inserts, refer to page 171).
- to attach 1/4" sockets, please order adaptor No 3115 (refer to page 170)
- with certificate
- display deviation value $\pm 4\%$

760 Torque screwdrivers TORSIOMETER

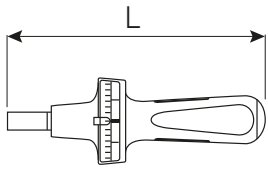

Code	size				inside ○	L mm	Δ g
51040007	7.5	15-75 cN·m	1.5-6.5 in·lb	2.5 cN·m	F 6.3	185	225
51040015	15	30-150 cN·m	3-13 in·lb	5 cN·m	F 6.3	185	225
51040030	30	60-300 cN·m	6-26 in·lb	10 cN·m	F 6.3	185	230
51040060	60	120-600 cN·m	12-52 in·lb	20 cN·m	F 6.3	185	230

TORSIOMAX 775

- click-type
- for torque-controlled bolt tightening in the cN·m and in·lb ranges
- for one-off or production runs
- anticlockwise and clockwise tightening
- with 1/4" internal hex drive (F 6.3 DIN 3126/ISO1173)
- infinitely variable via micrometer scale (twist scale)
- disengaging clutch coupling prevents the preset value being exceeded
- the shape of the handle and its surface texture ensure safe and accurate transmission of torque

- insert tools: For all 1/4" hex E 6.3, Phillips-head screws, POZIDRIV/SUPADRIV®, straight-slot, TORX®, hex BITS (see pp. 173). For very small joints, BITS with a 4 mm hex drive and an adapter No 3115/2 for BITS screwdriver inserts, Type C4, and external hex 1/4" (E 6.3 DIN 3126/ISO 1173) are required (refer to pages 166, 169).
- with certificate
- display deviation value $\pm 6\%$

775 Torque screwdrivers TORSIOMAX



Code	size			inside ○	L mm	Δ g
51060003	3 ¹⁾	2-30 cN·m	0.2 cN·m	F 6.3	105	99
51060012	12 ²⁾	20-120 cN·m	1 cN·m	F 6.3	157	192
51060030	30 ²⁾	40-300 cN·m	1 cN·m	F 6.3	160	214
51060050	50 ²⁾	100-500 cN·m	2.5 cN·m	F 6.3	205	436
51060100	100 ²⁾	400-1000 cN·m	5 cN·m	F 6.3	235	762
51460003	a/3 ³⁾	0.2-3 in·lb	0.02 in·lb	F 6.3	105	99
51460012	a/12 ³⁾	2-12 in·lb	0.1 in·lb	F 6.3	157	192
51460050	a/50 ³⁾	10-50 in·lb	0.25 in·lb	F 6.3	205	436

¹⁾ with a swivelling handle-end to improve tool control; and with a clamping screw for locking the preset.

²⁾ with an additional locking mechanism to prevent the selected torque being inadvertently adjusted.

³⁾ with screw-on handles for increasing the force applied for large torques.

Torque tools

MANOSKOP® 71

209-215

- indicating type
- mount for interchangeable shell tools
- all 14 x 18 mm insert tools can also be used with insert tool adaptor No 7370/80 (M 650 N·m)
- trailing pointer dial
- twin scales N·m/ft·lb
- scale is made of luminescent light yellow special film enabling clear readings even in poor light conditions
- handle with integrated force compensator
- measuring element is a bending plate housed in the handle
- with overload protection
- can be applied for either clockwise or anticlockwise tightening by turning the wrench over
- calibration using perfectControl calibrating unit No 7794 No 7794 or calibration system No 7706. Adjustment without disassembly.
- with certificate
- display deviation value $\pm 4\%$

71/80 MANOSKOP® torque wrench with dial gauge and mount for shell tools

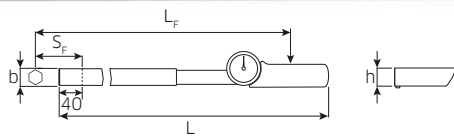

Code					mm	b mm	h mm	L mm	L _F mm	S _F mm	Δ g
50030080	160-800 N·m	120-600 ft·lb	10 N·m	10 ft·lb	24.5x28	28	24	1048	1050	95	2360

5

MANOSKOP® 71 with permanently installed reversible ratchet

- indicating type
- trailing pointer dial
- twin scales N·m/ft·lb
- scale is made of luminescent light yellow special film enabling clear readings even in poor light conditions
- additional protection for the gauge by the protective ring
- handle with integrated force compensator
- not for anticlockwise measurement
- calibration using perfectControl calibrating unit No 7794 or calibration system No 7706. Adjustment without disassembly.
- with certificate
- display deviation value $\pm 4\%$

71aR/80 MANOSKOP® torque wrench with dial gauge and permanently installed ratchet

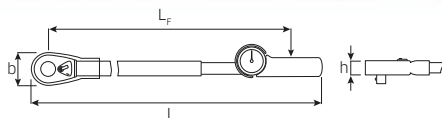

Code					"	b mm	h mm	L mm	L _F mm	Δ g
50450080	100-600 ft·lb	160-800 N·m	10 ft·lb	10 N·m	3/4	70	30	1152	1060	4280

Friction gauge

- indicating type
- permanently installed square drive for clockwise use
- trailing pointer dial
- no "needle wobble" during measurements
- lighter construction due to use of aluminium
- with certificate
- display deviation value $\pm 4\%$

73Nm/15 Friction gauge

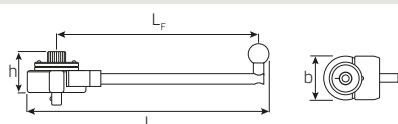

Code			"	b mm	h mm	L mm	L _F mm	S _F mm	Δ g
50240015	2-15 N·m	0.5 N·m	1/2	72	50	298.5	250	0	775

Industrial MANOSKOP® 755

For work on production lines or series production. No setting scale; have to be set with a tester such as the STAHLWILLE No 7707 W tester or the No 7794, No 7706 calibration system.

- click-type
- mount for interchangeable insert tools
- dual stop signal
- particularly light and easy to handle
- handle and shank are made of square tubular steel
- any force applied to the tool after the 'click' or applied in the opposite direction to the current function (up to the M of the wrench's range)

209-215

- does not act on the trigger mechanism and cannot cause damage to it.
- anticlockwise torquing thanks to swap-over insert tools
- on request with preset cut-out value (surcharge 10%)
- display deviation value $\pm 4\%$

755R/1 Series MANOSKOP® torque wrench with permanently installed ratchet

dual stop signal, click-type. Deviation of indication $\pm 4\%$. Cut-out setting with aid of Setting Gauge.

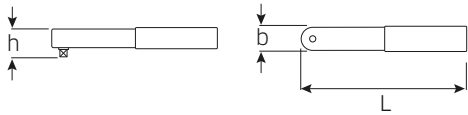

Code			"	b mm	h mm	L mm	$\Delta\%$ g
50 100001	1.5-12.5 N·m	1.0-9.0 ft·lb	1/4	22	18	173.5	335

755 Series MANOSKOP® torque wrenches with mount for insert tools

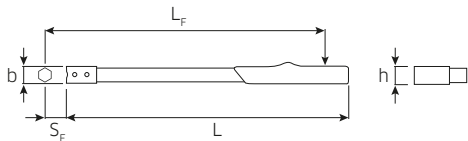

Code	size				b mm	h mm	L mm	L _F mm	S _F mm	$\Delta\%$ g
50010004	4	4-40 N·m	4-30 ft·lb	9x12	22	18	201	172	17.5	522
50010010	10	20-100 N·m	15-74 ft·lb	9x12	28	24	318	289	17.5	635
50010020	20	40-200 N·m	30-147 ft·lb	14x18	28	24	457	435	25	1060
50010030	30	60-300 N·m	40-220 ft·lb	14x18	28	24	609	587	25	1210



Industrial MANOSKOP® 755.
Accuracy - right down the line.



MANOSKOP® 730 Quick

Mechanical torque wrenches



Advantages at a glance

- Easy setting and operation
- Extremely resilient and durable
- Wear-resistant switching mechanism
- Torque range 4 - 800 N·m
- No need for manual reset to zero - wear-free flexible rod instead of a compression spring
- Can be calibrated without disassembly
- Clearly detected cut-out even at very small torque settings
- Rapid setting thanks to slide control (sizes 2 - 65)
- Display deviation value $\pm 4\%$

1

Protected mechanism, extremely resistant to mechanical wear, protected against dirt inside the outer housing

2

Easy-to-read twin scale for N·m/ft·lb and N·m/in·lb on sizes 5 - 80

3

Sturdy handle made of tough plastic, resistant to oils, grease, fuels, brake fluid and Skydrol

4

Square drive for use with a wide range of inserts (9x12 mm, 14x18 mm, 22x28 mm and 24.5x28 mm)

5

No need for manual reset to zero thanks to wear-free trigger system using triggering cam. The measuring element is only under load while force is being applied

6

Rapid setting thanks to easy-action locking lever in the handle. Ergonomically designed, non-slip adjuster with a thumb recess and an integrated magnifying glass in the display window.



7

Quick adjustment from outside, no disassembly of the torque wrench required

8

QuickRelease safety lock guarantees secure locking of insert tools on sizes 5 - 65 and fast removal

9

Any force applied to the tool after the ,click' or applied in the opposite direction to the current function - forcible loosening of a jammed screw - does not act on the trigger mechanism and cannot cause damage to it.

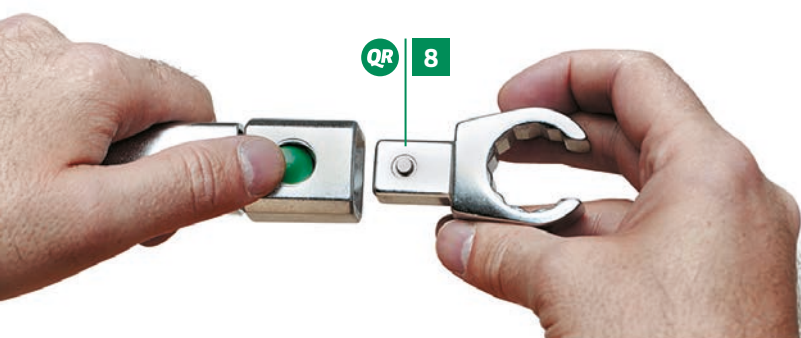

! Further details on **page 184**

Torque tools

Service MANOSKOP® 730

209-215

- click-type
- mount for interchangeable insert/shell tools
- QuickRelease safety lock (sizes 5-65)
- Rapid setting thanks to easy-action locking lever in the handle
- Ergonomically designed, non-slip adjuster with a thumb recess
- Magnifying glass integrated in the display window
- Optimised convex handle for strain-free working
- dual stop signal
- twin scales N·m/ft·lb and N·m/in·lb (sizes 5-80)
- the measuring element is only under load while force is being applied, no need for manual reset

- to zero
- can be applied for either clockwise or anticlockwise tightening by turning the inserts over
- any force applied to the tool after the 'click' or applied in the opposite direction to the current function - e.g. forcible loosening of a jammed screw - does not act on the trigger mechanism and cannot cause damage to it.
- calibration using perfectControl calibrating unit No 7794 or calibration system No 7706. Adjustment without disassembly.
- with certificate
- display deviation value $\pm 4\%$

730 Quick

Service MANOSKOP® torque wrenches with mount for insert tools

NEW

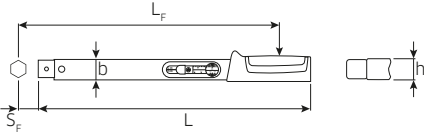

730/5 Quick

Code	size					mm	b mm	h mm	L mm	L _F mm	S _F mm	Δg
50 18 40 05	5	6-50 N·m	5-36 ft·lb	2 N·m	1 ft·lb	9x12	28	23	315	287.5	17.5	780
50 18 40 10	10	20-100 N·m	15-72.5 ft·lb	2.5 N·m	2.5 ft·lb	9x12	28	23	370	343	17.5	940
50 18 40 12	12	25-130 N·m	20-95 ft·lb	2.5 N·m	2.5 ft·lb	14x18	28	23	410	386	25	1080
50 18 40 20	20	40-200 N·m	30-145 ft·lb	5 N·m	5 ft·lb	14x18	28	23	455	431.5	25	1210
50 18 40 40	40	80-400 N·m	60-300 ft·lb	10 N·m	10 ft·lb	14x18	28	23	590	571.5	25	1620
50 18 40 65	65*	130-650 N·m	100-480 ft·lb	20 N·m	20 ft·lb	14x18	30.6	25.6	875	855	25	3190
50 18 45 65 II/65	65	130-650 N·m	100-480 ft·lb	20 N·m	20 ft·lb	22x28	30.6	25.6	897	906	55	4100
50 58 40 05	a/5	6-50 N·m	50-440 in·lb	2 N·m	10 in·lb	9x12	28	23	315	287.5	17.5	780
50 58 40 10	a/10	20-100 N·m	180-880 in·lb	2.5 N·m	20 in·lb	9x12	28	23	370	343	17.5	940
50 58 40 12	a/12	25-130 N·m	225-1150 in·lb	2.5 N·m	25 in·lb	14x18	28	23	410	386	25	1080
50 58 40 20	a/20	40-200 N·m	350-1750 in·lb	5 N·m	50 in·lb	14x18	28	23	455	431.5	25	1210

* recommended ratchet insert tool No 735/40HD

730

Service MANOSKOP® torque wrenches with mount for insert tools

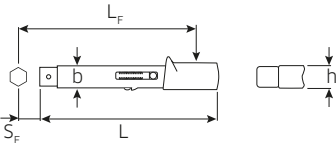

730/2

Code	size			mm	b mm	h mm	L mm	L _F mm	S _F mm	Δg
50 18 00 02	2	4-20 N·m	0.5 N·m	9x12	27.5	23	178.5	174	17.5	315
50 18 00 04	4	8-40 N·m	1 N·m	9x12	27.5	23	222	218	17.5	395
50 58 00 01	a/2-1	17.5-87.5 in·lb	2.5 in·lb	9x12	27.5	23	178.5	174	17.5	315
50 58 00 02	a/2	30-175 in·lb	5 in·lb	9x12	27.5	23	178.5	174	17.5	315
50 58 00 04	a/4	70-350 in·lb	10 in·lb	9x12	27.5	23	222	218	17.5	395

730/80

Service MANOSKOP® torque wrenches with mount for insert tools

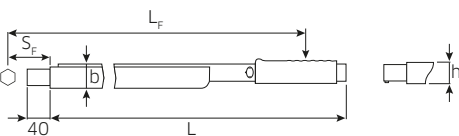

730/80

Code					mm	b mm	h mm	L mm	L _F mm	S _F mm	Δg
50 18 00 80	160-800 N·m	120-600 ft·lb	20 N·m	20 ft·lb	24.5x28	46	43	970	990	95	5377

Use shell adaptor No 7370/80 to make 14 x 18 mm insert tools fit.

Standard MANOSKOP® 721 Quick

- click-type
- Rapid setting thanks to easy-action locking lever in the handle
- Ergonomically designed, non-slip adjuster with a thumb recess
- Magnifying glass integrated in the display window
- dual stop signal
- twin scales N·m/ft·lb
- the measuring element is only under load while force is being applied, no need for manual reset to zero
- Optimised convex handle for strain-free working
- any force applied to the tool after the 'click' or applied in the opposite direction to the current function – e.g. forcible loosening of a jammed screw - does not act on the trigger mechanism and cannot cause damage to it.
- all the sensitive components are protected by the sturdy tubular steel housing
- calibration using perfectControl calibrating unit No 7794 or calibration system No 7706. Adjustment without disassembly.
- with certificate
- display deviation value $\pm 4\%$

721 Quick Standard MANOSKOP® torque wrenches permanently installed ratchet

NEW

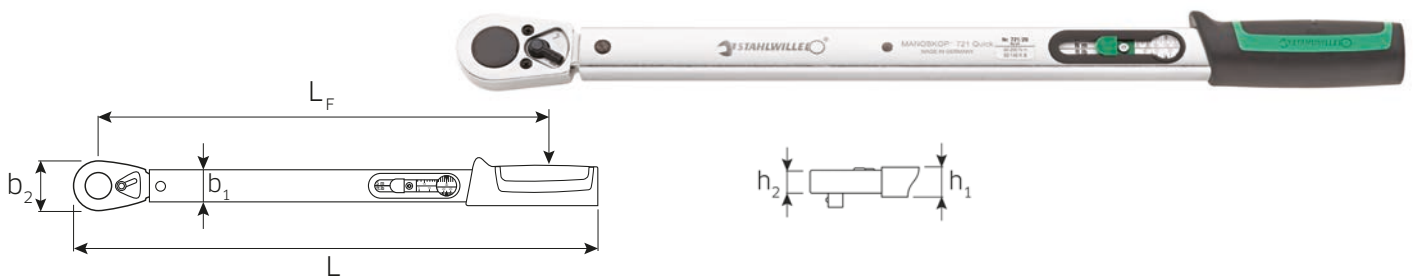

Code	size					■	b ₁ mm	b ₂ mm	h ₁ mm	h ₂ mm	L mm	L _F mm	Δg g
50 20 40 05	5	6-50 N·m	5-36 ft·lb	2 N·m	1 ft·lb	3/8	28	27.5	23	14.5	349.7	291	880
50 20 40 15	15	30-150 N·m	25-110 ft·lb	5 N·m	5 ft·lb	1/2	28	41	23	18	452.5	387	1280
50 20 40 20	20	40-200 N·m	30-150 ft·lb	5 N·m	5 ft·lb	1/2	28	41	23	18	482	416.5	1350
50 20 40 30	30	60-300 N·m	50-220 ft·lb	10 N·m	10 ft·lb	1/2	28	44	23	27.5	553	486	1650

size 30 with push through square drive for anticlockwise torquing (spare square drive, refer to page 220)

721QR Quick Standard MANOSKOP® torque wrench with permanently installed QuickRelease ratchet

NEW

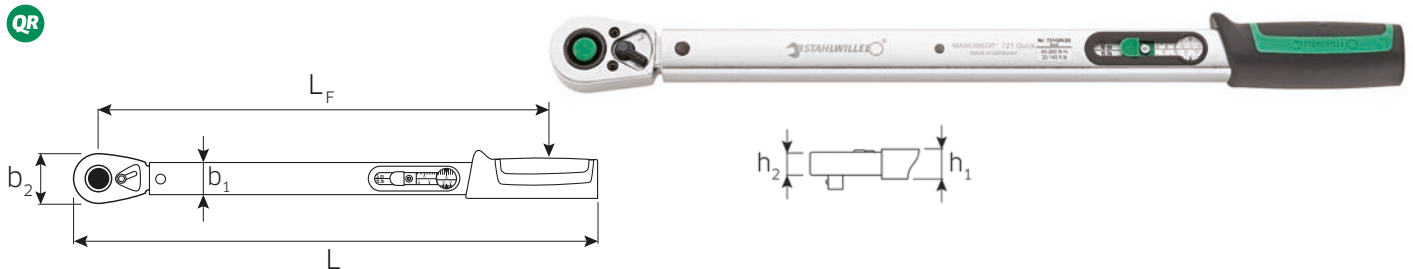

Code	size					■	b ₁ mm	b ₂ mm	h ₁ mm	h ₂ mm	L mm	L _F mm	Δg g
50 20 41 15	15	30-150 N·m	25-110 ft·lb	5 N·m	5 ft·lb	1/2	28	41	23	18	452.5	387	1268
50 20 41 20	20	40-200 N·m	30-150 ft·lb	5 N·m	5 ft·lb	1/2	28	41	23	18	482	416.5	1330

721QR/20/3/1 Wheel-fitting set Quick

NEW

Set of 5 in sturdy plastic case.
Contents

- 1 Standard MANOSKOP® No 721QR/20 Quick, 40-200 N·m, 30 - 150 ft·lb, with permanently installed QuickRelease ratchet, reversible, 1/2" ■ drive
- 3 wheel nut sockets No 51 IMP K, sizes 17 (green), 19 (blue), 20.8 mm (red)
- 1 extension 130 mm No 509QR/5



Code	Δg g	
96 50 72 14	2965	1

Torque tools

Standard MANOSKOP® 720Nf/721Nf

- click-type
- easy setting
- dual stop signal
- twin scales N·m/ft·lb
- anticlockwise torquing thanks to swap-over square drive
- all the sensitive components are protected by the sturdy tubular steel housing in the U-shaped aluminium profile
- calibration using perfectControl calibrating unit No 7794 or calibration system No 7706. Adjustment without disassembly.
- with certificate
- display deviation value $\pm 4\%$

720Nf/80 Standard MANOSKOP® torque wrench with permanently installed square drive

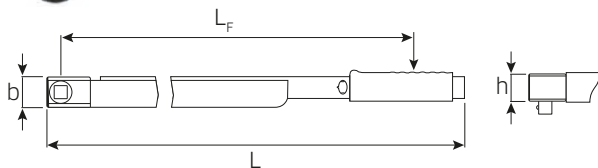

Code					"	b mm	h mm	L mm	L _F mm	S _F mm	Δ g
50 19 00 81	160-800 N·m	120-600 ft·lb	20 N·m	20 ft·lb	3/4	45	42	1034	938	0	6102

721Nf Standard MANOSKOP® torque wrenches with permanently installed ratchet



721Nf/80



721Nf/100

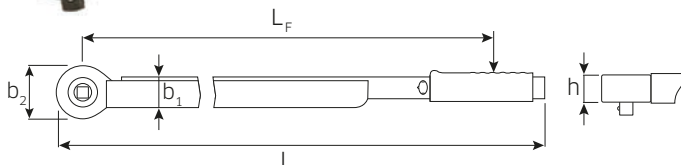

Code	size					"	b ₁ mm	b ₂ mm	h mm	L mm	L _F mm	Δ g
50 20 00 81	80	160-800 N·m	120-600 ft·lb	20 N·m	20 ft·lb	3/4	46.5	76	42	1051	938	7222
96 50 20 01	100	200-1000 N·m	150-725 ft·lb	25 N·m	25 ft·lb	3/4	46.5	76	42	1504	1365	7005

730R/40/32 Quick Torque wrench set

32 pieces, in steel case, for general service work.

Content:

- 1 SERVICE-MANOSKOP® No 730/40 Quick, 80-400 N·m
- 1 ratchet insert tool No 735/20, reversible, 1/2" ■-drive
- 1 square drive insert tool No 734/20, 1/2" ■-drive
- 7 o/e insert tools No 731/40, sizes 13, 15, 17, 19, 22, 27, 30 mm
- 1 No 3731/40 size 24 mm;
- 7 ring insert tools No 732/40, sizes 13, 15, 17, 19, 22, 24, 27 mm
- 10 sockets, bi-hexagon No 50, sizes 13, 14, 15, 17, 19, 22, 24, 27, 30, 32 mm
- 4 accessories, 1/2" ○-drive:
 - 1 T-handle No 506
 - 1 extension 255 mm No 509/10
 - 1 extension 130 mm No 509/5
 - 1 extension 55 mm No 509/2



Code	Δ g	
96 50 20 53	9739	1

This is how to achieve the correct tightening torque - even if you are using inserts with an extension

When you tighten fasteners using inserts whose extension length S deviates from the standard length S_F , it is necessary to recalculate the setting/display value for the torque wrench in use.

Caution! If adapters are combined with inserts or special tools, use the sum of the extensions = ΣS . Where the special tool is angled to the side, W_k will have to be determined empirically.

$$W_k = \frac{M_A \cdot L_F}{L_k} \left[\frac{N \cdot m \cdot mm}{mm} \right]$$

$$W_k = \frac{M_A \cdot L_F}{L_F - S_F + S \text{ (bzw. } \Sigma S)}$$

M_A = desired tightening torque
 W = reading/setting $W = M_A$
 W_k = adjusted reading or setting value $W_k \neq M_A$
 L_F = functional length (see dimension table for torque wrenches)
 L_k = adjusted functional length $L_k = L_F - S_F + S$ (or ΣS)

S = extension of STAHLWILLE inserts or special tools (see dimension table for inserts)
 S_F = standard extension (see dimension table for torque wrenches)
 ΣS = total of all extensions of the attached inserts
 $S_{\text{adapter}} + S_{\text{insert}} + \dots$

Normal situation

Torque wrench No 730N/10 combined with square drive insert tool No 734/5 and socket size 13 mm.
Required tightening torque for the screw $M_A = 40 \text{ N}\cdot\text{m}$

Dimension table for torque wrenches: $L_F = 336 \text{ mm}$, $S_F = 17.5 \text{ mm}$
 Dimension table for square drive insert tools: $S = 17.5 \text{ mm}$

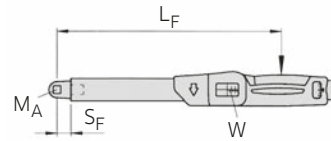

No adjustment to setting value required on torque wrench.

→ $S = S_F$
 → $W = M_A$

Example 1: adjusted setting value (1 insert tool)

Torque wrench No 730N/20 combined with ring insert tool No 732/40 size 36 mm.
Required tightening torque for the screw $M_A = 190 \text{ N}\cdot\text{m}$

Dimension table for torque wrenches: $L_F = 424.5 \text{ mm}$, $S_F = 25 \text{ mm}$
 Dimension table for ring insert tools: $S = 28 \text{ mm}$

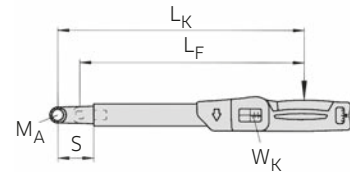

And this is what it looks like in the catalogue:

730N Basic wrenches with tool carrier for insert tools													
Code	size	mm	ft/lb	mm	ft/lb	mm	ft/lb	mm	ft/lb	mm	ft/lb		
50181002	2	2-20 N·m	20-180 in·lb	1 N·m	10 in·lb	0.2 N·m	9x12	28	23	275	226	17.5	737
50181005	5	10-50 N·m	7-37 ft·lb	5 N·m	1 ft·lb	0.25 N·m	9x12	28	23	330	280.5	17.5	831
50181010	10	20-100 N·m	15-75 ft·lb	10 N·m	2.5 ft·lb	0.5 N·m	9x12	28	23	386	336	17.5	988
50181012	12	25-130 N·m	20-95 ft·lb	10 N·m	2.5 ft·lb	0.5 N·m	10x18	28	23	421	379	25	1128
50181020	20	40-200 N·m	30-150 ft·lb	10 N·m	5 ft·lb	1 N·m	10x18	28	23	467	424.5	25	1264
50181040	40	80-400 N·m	60-300 ft·lb	20 N·m	10 ft·lb	2 N·m	10x18	28	23	607	564.5	25	1655
50181065	65	130-650 N·m	100-480 ft·lb	50 N·m	20 ft·lb	2.5 N·m	10x18	30.6	25.6	890	848	25	3231
50181365	1/65	130-650 N·m	100-480 ft·lb	50 N·m	20 ft·lb	2.5 N·m	22x28	30.6	25.6	911	900	55	3504
50181080	80	160-800 N·m	120-600 ft·lb	100 N·m	25 ft·lb	5 N·m	22x28	30.6	25.6	1178	1167	55	4882
50181100	100	200-1000 N·m	150-750 ft·lb	100 N·m	25 ft·lb	5 N·m	22x28	30.6	25.6	1363	1297	55	5300
50581002	a/2	20-180 in·lb	1.5-15 ft·lb	10 in·lb	0.5 ft·lb	2 in·lb	9x12	28	23	275	226	17.5	737
50581005	a/5	90-450 in·lb	7-37 ft·lb	50 in·lb	1 ft·lb	2.5 in·lb	9x12	28	23	330	280.5	17.5	831
50581010	a/10	180-900 in·lb	15-75 ft·lb	100 in·lb	2.5 ft·lb	5 in·lb	9x12	28	23	386	336	17.5	988
50581020	a/20	350-1800 in·lb	30-150 ft·lb	100 in·lb	5 ft·lb	10 in·lb	10x18	28	23	467	424.5	25	1264
50581040	a/40	60-300 ft·lb	800-3600 in·lb	20 ft·lb	100 in·lb	2 ft·lb	10x18	28	23	607	564.5	25	1655

* recommended ratchet insert tool No 735/40HD

$$W_k = \frac{M_A \cdot L_F}{L_F - S_F + S} = \frac{190 \text{ N}\cdot\text{m} \cdot 424.5 \text{ mm}}{424.5 \text{ mm} - 25 \text{ mm} + 28 \text{ mm}} = \frac{190 \text{ N}\cdot\text{m} \cdot 424.5 \text{ mm}}{427.5 \text{ mm}} = 188.7 \text{ N}\cdot\text{m}$$

Adjusted setting value $W_k = 188.7 \text{ N}\cdot\text{m}$
 → value to set 189 N·m

→ $S \neq S_F$
 → $W \neq M_A$

732/40 Ring insert tools							
Code	mm	mm	b mm	h mm	S mm	mm	mm
58224013	13	10x10	22.5	11	25	130	
58224014	14	10x10	23	11	25	123	
58224015	15	10x10	24	11	25	128	
58224016	16	10x10	25.5	12	25	133	
58224017	17	10x10	27	12	25	135	
58224018	18	10x10	29	13	25	134	
58224019	19	10x10	30.5	13	25	138	
58224021	21	10x10	33	15	25	144	
58224022	22	10x10	34.5	15	25	145	
58224024	24	10x10	37.5	15	25	153	
58224027	27	10x10	42.5	17	25	162	
58224028	28	10x10	45.5	19	25	175	
58224030	30	10x10	46	19	25	182	
58224032	32	10x10	47.5	19	25	181	
58224034	34	10x10	52	19	28	210	
58224036	36	10x10	54	19	28	203	
58224041	41	10x10	60	20	30'	240	

* Caution! Modified settings on torque wrench (refer to note on page 187).

Example 2: adjusted reading (insert tool and adapter)

Torque wrench No 730N/10 combined with square drive insert tool No 734/5 and adapter No 447 size 10 mm.
Required tightening torque for the screw $M_A = 25 \text{ N}\cdot\text{m}$

Dimension table for torque wrenches: $L_F = 336 \text{ mm}$, $S_F = 17.5 \text{ mm}$
 Dimension table for square drive insert tools: $S_F = 17.5 \text{ mm}$
 Dimension table for adapters: $\Sigma S = 50.8 \text{ mm}$

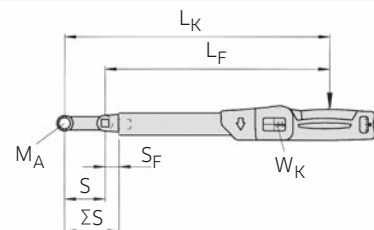

$$W_k = \frac{M_A \cdot L_F}{L_F - S_F + \Sigma S} = \frac{25 \text{ N}\cdot\text{m} \cdot 336 \text{ mm}}{336 \text{ mm} - 17.5 \text{ mm} + 17.5 \text{ mm} + 50.8 \text{ mm}} = \frac{25 \text{ N}\cdot\text{m} \cdot 336 \text{ mm}}{386.8 \text{ mm}}$$

Adjusted setting value $W_k = 21.7 \text{ N}\cdot\text{m}$

→ $\Sigma S \neq S_F$
 → $W \neq M_A$



MANOSKOP® 730N

Mechanical torque wrench



Benefits at a glance:

- Accurate one-handed setting - quick & easy control using the knob at the end of the handle
- Audible setting positions
- Fail-safe setting mechanism in the knob
- Clearly readable twin scale (N·m and ft·lb)
- Noticeable double signals when the preset torque is reached
- Square drives with
- QuickRelease safety locks - for 9x12, 14x18 and 22x28 mm
- Handle is resistant to oils, grease, fuels, brake fluids and Skydrol
- Deviation of indication $\pm 3\%$

1

Protected mechanism extremely resistant to mechanical wear, protected against dirt inside the outer housing

2

Easily readable double scale. The colour differentiation between the N·m and ft·lb scales simplifies fine setting

3

Two-component handle made of extremely tough, impact resistant plastic with a kind-to-the-hands softer layer

4

Ring scale with fine settings for the black measuring range on the twin scale

5

QuickSelect rapid setting: Pull, set, lock. All using the one setting knob

6

No need for manual reset to zero thanks to the wear-free triggering cam system. The measuring element is only under load while force is being applied.

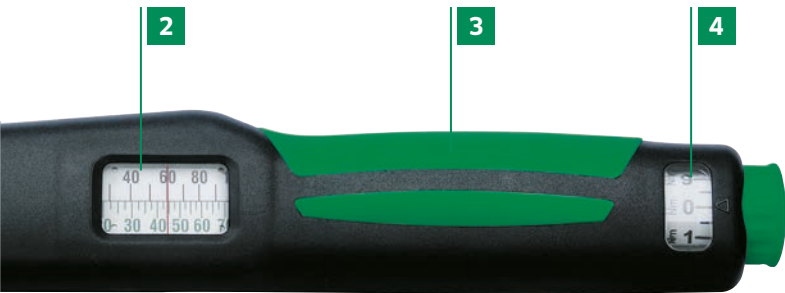

Also available with adaptor for 22x28 mm

- Tighten large torques effortlessly
- High long-term durability
- 650 - 1000 N·m

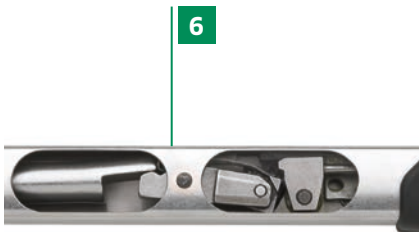

5

7 The square drive enables a broad range of tightening tools

8 Rapid adjustment from outside, no disassembly of the torque wrench

9 QuickRelease safety lock
Firm locking and rapid change of insert tools thanks to the QuickRelease safety lock

10 Integrated clockwise and anticlockwise operation simply by turning over the wrench and insert tool

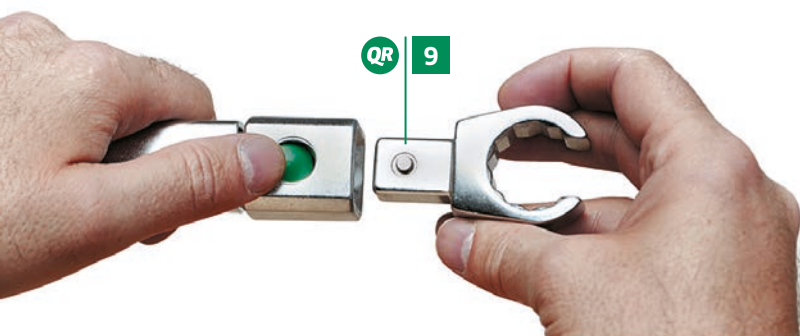

! Further details
on page 190

Torque tools

Service MANOSKOP® 730N

- click-type
- mount for interchangeable insert tools
- QuickRelease safety lock
- fast, accurate setting thanks to QuickSelect quick-action adjuster
- dual stop signal
- easy-to-read double scale with colour coding to differentiate between N·m/ft·lb and ft·lb/in·lb scales
- the measuring element is only under load while force is being applied, no need for manual reset to zero
- can be applied for either clockwise or anticlockwise tightening by turning the inserts over
- any force applied to the tool after the 'click' or

209-215

- applied in the opposite direction to the current function - e.g. forcible loosening of a jammed screw - does not act on the trigger mechanism and cannot cause damage to it.
- two-component handle with ergonomically designed green softer layers (resistant to oils, grease, fuels, brake fluids and Skydrol)
- calibration using perfectControl calibrating unit No 7794 or calibration system No 7706. Adjustment without disassembly.
- with certificate
- registered design
- display deviation value $\pm 3\%$

730N

Service MANOSKOP® torque wrenches with mount for insert tools

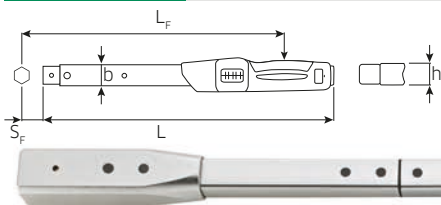

Code	size					Fine scale		b mm	h mm	L mm	L _F mm	S _F mm	$\Delta\Delta$ g
50 18 10 02	2	2-20 N·m	20-180 in·lb	1 N·m	10 in·lb	0.2 N·m	9x12	28	23	275	226	17.5	737
50 18 10 05	5	10-50 N·m	7-37 ft·lb	5 N·m	1 ft·lb	0.25 N·m	9x12	28	23	330	280.5	17.5	831
50 18 10 10	10	20-100 N·m	15-75 ft·lb	10 N·m	2.5 ft·lb	0.5 N·m	9x12	28	23	386	336	17.5	988
50 18 10 12	12	25-130 N·m	20-95 ft·lb	10 N·m	2.5 ft·lb	0.5 N·m	14x18	28	23	421	379	25	1128
50 18 10 20	20	40-200 N·m	30-150 ft·lb	10 N·m	5 ft·lb	1 N·m	14x18	28	23	467	424.5	25	1264
50 18 10 40	40	80-400 N·m	60-300 ft·lb	20 N·m	10 ft·lb	2 N·m	14x18	28	23	607	564.5	25	1655
50 18 10 65	65*	130-650 N·m	100-480 ft·lb	50 N·m	20 ft·lb	2.5 N·m	14x18	30.6	25.6	890	848	25	3231
50 18 13 65	II/65	130-650 N·m	100-480 ft·lb	50 N·m	20 ft·lb	2.5 N·m	22x28	30.6	25.6	911	900	55	3504
50 18 10 80	80	160-800 N·m	120-600 ft·lb	100 N·m	25 ft·lb	5 N·m	22x28	30.6	25.6	1178	1167	55	4825
50 18 11 00	100	200-1000 N·m	150-750 ft·lb	100 N·m	25 ft·lb	5 N·m	22x28	30.6	25.6	1363	1352	55	5000
50 58 10 02	a/2	20-180 in·lb	1.5-15 ft·lb	10 in·lb	0.5 ft·lb	2 in·lb	9x12	28	23	275	226	17.5	737
50 58 10 05	a/5	90-450 in·lb	7-37 ft·lb	50 in·lb	1 ft·lb	2.5 in·lb	9x12	28	23	330	280.5	17.5	831
50 58 10 10	a/10	180-900 in·lb	15-75 ft·lb	100 in·lb	2.5 ft·lb	5 in·lb	9x12	28	23	386	336	17.5	988
50 58 10 20	a/20	350-1800 in·lb	30-150 ft·lb	100 in·lb	5 ft·lb	10 in·lb	14x18	28	23	467	424.5	25	1264
50 58 10 40	a/40	60-300 ft·lb	800-3600 in·lb	20 ft·lb	100 in·lb	2 ft·lb	14x18	28	23	607	564.5	25	1655

* recommended ratchet insert tool No 735/40HD

730NR

Service MANOSKOP® torque wrenches with permanently installed fine-tooth ratchet

in sturdy plastic case (size 65 in steel case). Deviation of indication $\pm 4\%$.

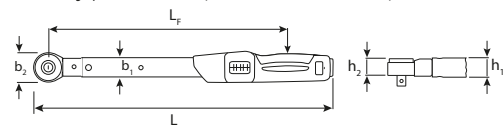

Code	size					Fine scale	"	b ₁ mm	b ₂ mm	h ₁ mm	h ₂ mm	L mm	L _F mm	$\Delta\Delta$ g	$\Delta\Delta$ g with box
96 50 31 05	5 FK	10-50 N·m	7-37 ft·lb	5 N·m	1 ft·lb	0.25 N·m	3/8	28	33	23	24	364	280.5	973	1763
96 50 31 10	10 FK	20-100 N·m	15-75 ft·lb	10 N·m	2.5 ft·lb	0.5 N·m	1/2	28	33	23	24	420	336.5	1146	1934
96 50 31 20	20 FK	40-200 N·m	30-150 ft·lb	10 N·m	5 ft·lb	1 N·m	1/2	28	43	23	26	513.5	425	1583	2370
96 50 21 40	40 FK	80-400 N·m	60-300 ft·lb	20 N·m	10 ft·lb	2 N·m	3/4	28	50	23	31.5	657	564.5	2122	2657
96 50 22 65	65 FK-HD	130-650 N·m	100-480 ft·lb	50 N·m	20 ft·lb	2.5 N·m	3/4	30.6	58	25.6	36	944	848	3698	6188

730NR

Service MANOSKOP® torque wrench with permanently installed QuickRelease ratchet

in sturdy plastic case (size 65 in steel case). Ratchet has QuickRelease safety lock. Deviation of indication $\pm 4\%$.

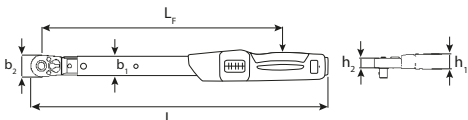

Code	size					Fine scale	"	b ₁ mm	b ₂ mm	h ₁ mm	h ₂ mm	L mm	L _F mm	$\Delta\Delta$ g	$\Delta\Delta$ g with box
96 50 21 05	5QR FK	10-50 N·m	7-37 ft·lb	5 N·m	1 ft·lb	0.25 N·m	3/8	28	29	23	14.5	372.5	291	961	1386
96 50 21 10	10QR FK	20-100 N·m	15-75 ft·lb	10 N·m	2.5 ft·lb	0.5 N·m	1/2	28	29	23	14.5	428.5	346.5	1129	1554
96 50 21 20	20QR FK	40-200 N·m	30-150 ft·lb	10 N·m	5 ft·lb	1 N·m	1/2	28	41	23	18	526	438.5	1589	2014

Service MANOSKOP® 730 Fix

- click-type
- for daily use in series production
- the setting knob can be unscrewed after the target has been set - making inadvertent changes to the settings impossible
- the Torx® TAMPER-RESISTANT locking screw supplied with the tool also protects against unwanted manipulation.
- The adhesive seals supplied offer a further level of security. It is not possible to adjust the setting without breaking the seal.
- mount for interchangeable insert tools
- QuickRelease safety lock
- fast, accurate setting thanks to QuickSelect quick-action adjuster
- dual stop signal
- easy-to-read double scale with colour coding to differentiate between N·m/ft·lb and ft·lb/in·lb scales
- the measuring element is only under load while force is being applied, no need for manual reset to zero
- can be applied for either clockwise or anticlockwise tightening by turning the inserts over
- any force applied to the tool after the 'click' or applied in the opposite direction to the current function - e.g. forcible loosening of a jammed screw - does not act on the trigger mechanism and cannot cause damage to it.
- two-component handle with ergonomically designed green softer layers (resistant to oils, grease, fuels, brake fluids and Skydrol)
- calibration using perfectControl calibrating unit No 7794 or calibration system No 7706. Adjustment without disassembly.
- with certificate
- DBGM
- display deviation value $\pm 3\%$

209-215

730 Fix Service MANOSKOP® torque wrenches with mount for insert tools

NEW



Code	size					Fine scale		b mm	h mm	L mm	L _F mm	S _F mm	Δ g
96 50 30 05	5	10-50 N·m	7-37 ft·lb	5 N·m	1 ft·lb	0.25 N·m	9x12	28	23	330	280.5	17.5	831
96 50 30 10	10	20-100 N·m	15-75 ft·lb	10 N·m	2.5 ft·lb	0.5 N·m	9x12	28	23	386	336	17.5	988
96 50 30 12	12	25-130 N·m	20-95 ft·lb	10 N·m	2.5 ft·lb	0.5 N·m	14x18	28	23	421	379	25	1128
96 50 30 20	20	40-200 N·m	30-150 ft·lb	10 N·m	5 ft·lb	1 N·m	14x18	28	23	467	424.5	25	1264
96 50 30 40	40	80-400 N·m	60-300 ft·lb	20 N·m	10 ft·lb	2 N·m	14x18	28	23	607	564.5	25	1655
96 50 30 65	65*	130-650 N·m	100-480 ft·lb	50 N·m	20 ft·lb	2.5 N·m	14x18	30.6	25.6	890	848	25	3231
96 50 34 65	II/65	130-650 N·m	100-480 ft·lb	50 N·m	20 ft·lb	2.5 N·m	22x28	30.6	25.6	911	900	55	3504
96 50 30 80	80	160-800 N·m	120-600 ft·lb	100 N·m	25 ft·lb	5 N·m	22x28	30.6	25.6	1178	1167	55	4825
96 50 31 00	100	200-1000 N·m	150-750 ft·lb	100 N·m	25 ft·lb	5 N·m	22x28	30.6	25.6	1363	1352	55	5000
96 58 30 05	a/5	90-450 in·lb	7-37 ft·lb	50 in·lb	1 ft·lb	2.5 in·lb	9x12	28	23	330	280.5	17.5	831
96 58 30 10	a/10	180-900 in·lb	15-75 ft·lb	100 in·lb	2.5 ft·lb	5 in·lb	9x12	28	23	386	336	17.5	988
96 58 30 20	a/20	350-1800 in·lb	30-150 ft·lb	100 in·lb	5 ft·lb	10 in·lb	14x18	28	23	467	424.5	25	1264
96 58 30 40	a/40	60-300 ft·lb	800-3600 in·lb	20 ft·lb	100 in·lb	2 ft·lb	14x18	28	23	607	564.5	25	1655

* recommended ratchet insert tool No 735/40HD

TRIPLE SAFETY.

The setting knob can be unscrewed after the target has been set - making inadvertent changes to the settings impossible.

The Torx® TAMPER-RESISTANT locking screw supplied with the tool also protects against unwanted manipulation.

The adhesive seals supplied offer a further level of security. It is not possible to adjust the setting without breaking the seal.





SENSOTORK® 701

Electronic torque wrench



Advantages at a glance

- Slim, compact shape for smaller torques from 1 N·m upwards
- Units of measure: N·m, cN·m, ft·lb, in·lb
- Readings independent of point of application of force
- Indicating - for a broad torque range from 1 to 20 N·m.
- With additional SENSOMASTER 4 software:
 - Adjustable joints
 - Evaluation of tightening operation by means of coloured LEDs, buzzer and vibration
 - Calibrating interval adjustable
 - Logging function
- Supplied with battery
- For use in conjunction with perfectControl calibrating unit No 7794 or calibration system No 7706. Readjustment does not require disassembly
- With certificate
- Display deviation value $\pm 4\%$

1

Safe. Thanks to the permanently integrated fine-tooth ratchet with 80 teeth and QuickRelease technology.

2

Compact. The ergonomically constructed design is extremely slim and enables working even in the most awkward places.

3

Versatile. Three measuring methods: track, peak hold, joint evaluation.

4

Accurate. SENSOTORK® 701 measures to within $\pm 4\%$. Always.

5

Intuitive. The required mode of operation can be quickly and easily set using the single-button setting system.

6

Ergonomically designed. Strain-free working thanks to the specially designed handle.

SENSOTORK® 701 electronic torque wrench

- indicating
- slim, compact shape for smaller torques from 1 N·m upwards
- measuring units: N·m, cN·m, ft·lb, in·lb
- measurements independent of the point of application of force
- additional functions using SENSOMASTER 4 software (freely available after registration at www.stahlwille.de/sensomaster):
 - adjustable joints
 - evaluation of tightening operation by means of coloured LEDs, buzzer and vibration
 - calibrating interval adjustable
 - logging function
- supplied with 3.6 V Li-ion battery, type 14500, packed in accordance with UN3091, Class 9
- calibration in conjunction with perfectControl calibrating unit No 7794 or complete calibration system No 7706. Readjustment does not require disassembly
- with certificate
- display deviation value $\pm 4\%$

701/2 Electronic torque wrench with permanently installed fine-tooth ratchet

QR

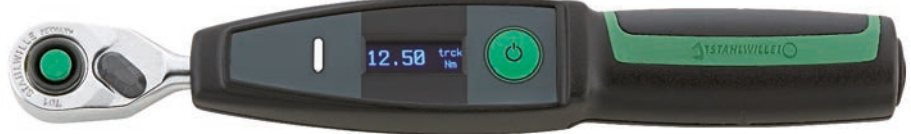
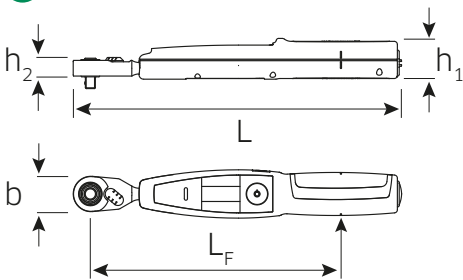

Code					"	b mm	h ₁ mm	h ₂ mm	L mm	L _F mm	Δ _g g	Δ _g g with box
96 50 45 02	1-20 N·m	100-2000 cN·m	0,7-15 ft·lb	9-180 in·lb	1/4	22.6	26	10	210	160	145	716
96 50 46 02	1-20 N·m	100-2000 cN·m	0,7-15 ft·lb	9-180 in·lb	1/4	22.6	26	10	210	160	145	700

96 50 46 02 - As for 96 50 45 02, but without battery (not hazardous)

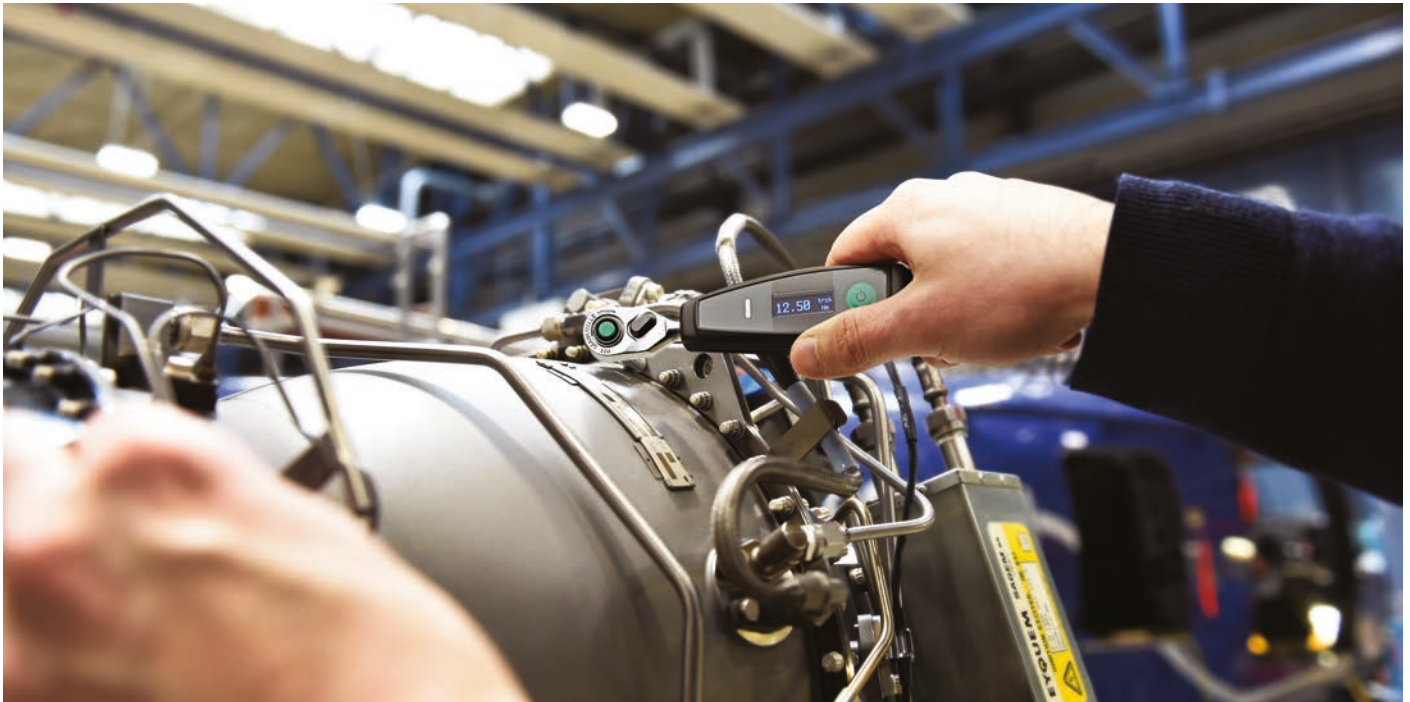

Note!

Torque tightening tools are measuring instruments. They must be regularly calibrated with suitable instruments and adjusted accordingly (refer to DIN EN ISO 6789-1, 5.3 Conformance test during use and DIN EN ISO 6789-2, 4.1 Calibration during use).



STAHLWILLE angle-controlled torque wrenches.

For absolute accuracy.



For high-accuracy applications - Category A bolted connections, for example - just checking the torque is not enough. As well as the torque, it is crucial to tighten to the correct tightening angle

5

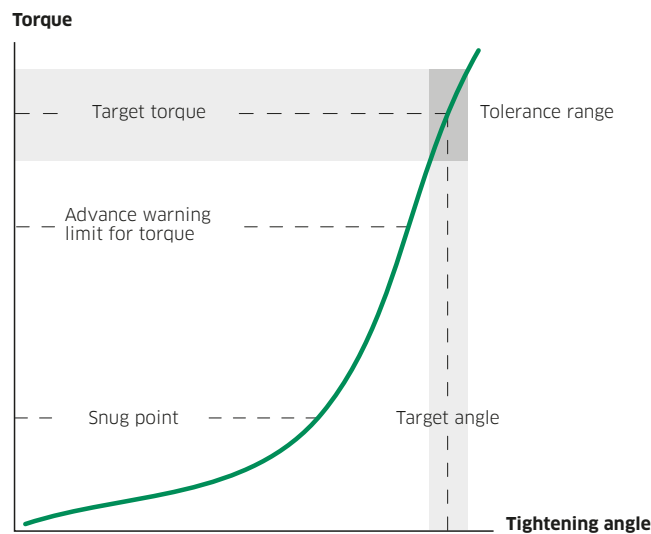

The torque reading specifies how much force was applied to tighten a fastener. For many applications, this is perfectly good enough. However, in certain cases, the additional measure of accuracy is an essential requirement. The tightening force that is generated between the workpieces in a bolted joint has to be exactly adhered to: if the force is too great, there is a risk of breakage. If it is too low, on the other hand, the connection will not be firm enough and may lead to failure in the assembly under normal operating conditions. Since the tightening force is dependent on the tightening torque and the angle, measuring equipment that can measure both quantities exactly is required. For applications of this kind, STAHLWILLE has precisely the solutions industry needs.



MANOSKOP® 730D
+ Angle Module 7395-1

→ 196



MANOSKOP® 714

→ 200



SENSOTORK® 713R

→ 204

- Accurate control:** Uncertainty is reduced to a minimum to guarantee accurate readings.
- Higher quality bolted connections:** Including the tightening angle as the second measured quantity makes the bolted joint even more secure.
- Perfect procedures:** Easily readable, unmistakable displays and automatic switch-over to angle-controlled measurement once the target tightening torque has been reached – key features in efficient, safe work practice.
- Excellent economy:** Thanks to the considerably extended measuring range, every angle-controlled torque wrench can replace as many as four mechanical torque wrenches (two indicating and two clicking), which simultaneously reduces the costs of maintenance, calibration and adjustment. All these models are suitable for clockwise and anticlockwise tightening.
- Better monitoring:** All our angle-controlled torque wrenches have a logging function. Using the corresponding software (in some cases this is an optional extra), it is possible to read out programmed, stored readings and archive them on the PC – for example by the serial number of the tool, date and timestamp of the tightening operation, target torque and angle and the torques and angles actually recorded.



MANOSKOP® 730D

Electromechanical torque wrench



Benefits at a glance:

- Indicating and click-type
- Displays the torque actually applied after the wrench cuts out. In this way, the user has the opportunity to optimise his or her working methods.
- Units of measurement: N·m / ft·lb / in·lb
- Automatic keypad lock
- Display also works for anticlockwise torque
- Angle-controlled measurement using a supplementary module
- Overload protection by means of acoustic and visual signals
- Automatic compensation to achieve correct tightening torque even if a changed extension is entered
- Different tolerance limits can be set for each joint
- Visual red and green signals in the display confirm the status of the joint
- Additional security for presets using PIN code
- Automatic notification of the next calibration date
- Deviation of indication $\pm 2\%$

Measure, cut-out and record: When the preset torque is reached, the torque wrench cuts out and indicates this fact to the user via a definite tactile and audible signal. The tightening torques are stored. The data can be transferred to a PC for evaluation and documentation.

1

The square drive enables a broad range of insert tools

2

Dual stop signal with tactile and acoustic cut-out signals

3

Easy-to-read display

4

Rapid setting

The convenient keypad enables the torque wrench to be quickly and easily set



Also available with adaptor for 22x28 mm

- Tighten large torques effortlessly
- High long-term durability
- 650 - 1000 N·m



7395-1

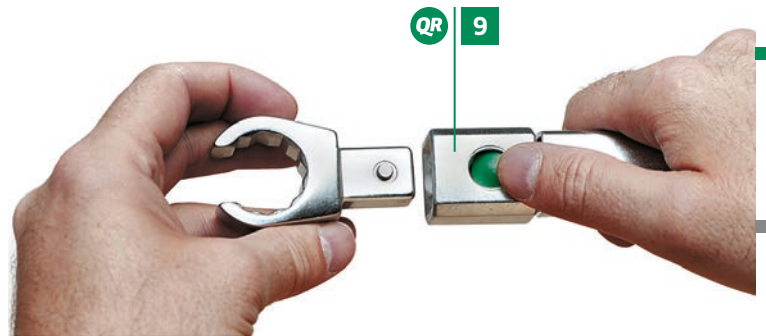

5

Power supply two 1.5 V AA batteries

6

Angle controlled tightening

Simply attach the Angle Module No 7395-1 and connect the cable to the interface

7

Data output USB interface

8

2-component handle has ergonomically designed, green softer layers and is resistant to oils, grease, fuels, brake fluids and Skydrol.

9

QuickRelease safety lock

! Further details
on page 198

Service work & series production MANOSKOP® 730D - indicating and click-type

- tactile and acoustic trigger signal
 - mount for interchangeable insert tools
 - QuickRelease safety lock
 - fast setting using convenient keypad
 - automatic compensation to achieve correct tightening torque even if a changed extension is entered
 - overload protection by means of acoustic and visual signals
 - automatic keypad lock prevents inadvertent changes
 - angle-controlled measurements using Angle Module No 7395-1 (refer to page 201)
 - display also works for anticlockwise torque
 - units of measurement: N·m, ft·lb, in·lb
 - different tolerance limits can be set for each joint
 - visual red and green signals in the display confirm the status of the joint
- 209-215
- additional security for presets (function mode, trigger or preset value, unit of measurement, tolerance, save, deviating extension) using PIN code
 - up to 7.500 measurements can be stored
 - USB interface
 - automatic notification of the next calibration date
 - calibration using perfectControl calibrating unit No 7794 or calibration system No 7791
 - two-component handle with ergonomically designed green softer layers (resistant to oils, grease, fuels, brake fluids and Skydrol)
 - with certificate
 - in sturdy plastic case (sizes 40-100 in steel case)
 - patent
 - supplied with two 1.5 V AA batteries. AA/LR6, 1.2 V rechargeable cells may also be used
 - display deviation value $\pm 2\%$, ± 1 digit

730D Service/Series MANOSKOP® torque wrenches with mount for insert tools

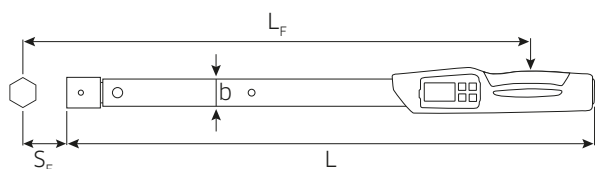

Code	size	Setting/display resolution			mm	b	h	L	L _F	S _F	Δ _g	Δ _g with box			
		N·m	ft·lb	in·lb											
96 50 17 10	10	10-100 N·m	7.4-75 ft·lb	90-900 in·lb	0.2/0.1	0.2/0.1	2/1.0	9x12	28	23	467	426.5	17.5	1085	1510
96 50 17 20	20	20-200 N·m	15-150 ft·lb	180-1800 in·lb	0.5/0.1	0.5/0.1	5/1.0	14x18	28	23	548	515	25	1361	1896
96 50 17 40	40	40-400 N·m	30-300 ft·lb	360-3600 in·lb	1.0/0.1	1.0/0.1	10/1.0	14x18	28	23	688	655	25	1765	5155
96 50 17 65	65*	65-650 N·m	48-480 ft·lb	580-5800 in·lb	1.0/0.1	1.0/0.1	10/1.0	14x18	30.6	25.6	870	837	25	3300	6000
96 50 19 65 II/65	65	65-650 N·m	48-480 ft·lb	580-5800 in·lb	1.0/0.1	1.0/0.1	10/1.0	22x28	30.6	25.6	892	889	55	3224	7500
96 50 20 80	80	80-800 N·m	60-600 ft·lb	720-7200 in·lb	1.0/1.0	1.0/1.0	10/1.0	22x28	30.6	25.6	1160	1157	55	4577	10500
96 50 21 00	100	100-1000 N·m	74-750 ft·lb	900-9000 in·lb	1.0/1.0	1.0/1.0	10/1.0	22x28	30.6	25.6	1344	1341	55	4995	11000

* recommended ratchet insert tool No 735/40HD

730DR Service/Series MANOSKOP® torque wrenches with reversible ratchet insert tool



Code	size	Setting/display resolution			mm	"	Δ _g	Δ _g with box			
		N·m	ft·lb	in·lb							
96 50 18 10	10	10-100 N·m	7.4-75 ft·lb	90-900 in·lb	0.2/0.1	0.2/0.1	2/1.0	9x12	1/2	1232	1657
96 50 18 20	20	20-200 N·m	15-150 ft·lb	180-1800 in·lb	0.5/0.1	0.5/0.1	5/1.0	14x18	1/2	1663	2198
96 50 18 40	40	40-400 N·m	30-300 ft·lb	360-3600 in·lb	1.0/0.1	1.0/0.1	10/1.0	14x18	3/4	2232	4722
96 50 18 65	65	65-650 N·m	48-480 ft·lb	580-5800 in·lb	1.0/0.1	1.0/0.1	10/1.0	14x18	3/4	3767	6530
96 50 20 65 II/65	65	65-650 N·m	48-480 ft·lb	580-5800 in·lb	1.0/0.1	1.0/0.1	10/1.0	22x28	3/4	3994	9000
96 50 18 80	80	80-800 N·m	60-600 ft·lb	720-7200 in·lb	1.0/0.1	1.0/0.1	10/1.0	22x28	3/4	6492	12500
96 50 18 00	100	100-1000 N·m	74-750 ft·lb	900-9000 in·lb	1.0/0.1	1.0/0.1	10/1.0	22x28	3/4	6910	12500

7759-5 USB hub, jack cable and SENSOMASTER 4 software

NEW

- SENSOMASTER 4 - one software package for all electronic torque wrenches from STAHLWILLE
- Self-explanatory thanks to intuitive GUI with clearly organised tabbed layout
- Quick and easy programming for electronic torque wrenches
- Enables comprehensive evaluations, for example in connection with quality assurance
- Read out stored wrench data and joint readings:
 - Joint identifier
 - Tool serial number
 - Date and time of tightening operation
 - Target torque or target angle
 - Torque level at which the tool cuts out
 - Tightening torque or angle reached
 - Tolerances
 - Joint evaluation
- Storage of joint data in a database
- Delete or print highlighted joints from the database
- Export displayed joint data to a range of file formats (*.XLS;*.CSV;*.ODG)
- User management
- Define new PIN
- Delete joint data stored in wrench

System requirements:

- PC
- From Microsoft Windows XP on
- USB connection

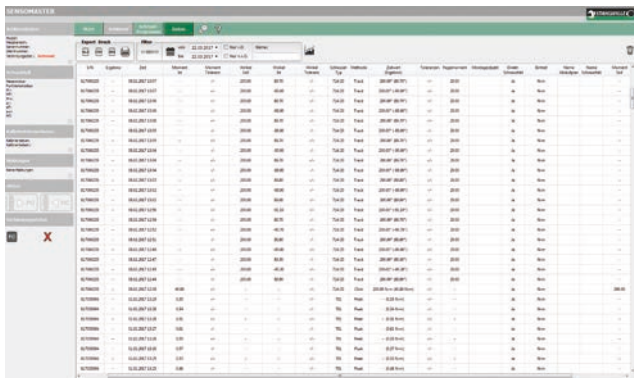

Code	L	Δ
96 58 36 30	1.5	137

7395-1 Angle Module for No 730D

Patents applied for, angle-controlled measurement without a reference arm. For torque wrench No 730D from software release 1.5.8. Torque wrenches No 730D fitted with older releases of the software can be upgraded. Simply attach the module and connect to the torque wrench interface and the No 730D can be used for angle controlled tightening. The measurements are read off and settings made via the torque wrench. When the preset snug point is reached, the torque wrench automatically switches over to angle-controlled measurement in degrees. Depending on the options selected, the torque wrench will either cut out when the preset angle is reached or an alarm is heard. One 1.5 V battery is included in the package. Deviation of indication ± 1%.



Code	Δ
96 58 46 28	500

7751 Jack cable

with jacks at both ends, 90° angled.



Code	L	Δ
52 11 00 51	1.5	50

7757-1 USB adaptor



Code	Δ
52 11 10 57	10



MANOSKOP® 714

Electromechanical angle-controlled torque wrench



Benefits at a glance:

- Indicating and click-type
- 4 measuring methods (torque, angle, torque backed up by angle, angle backed up by torque)
- Freely configurable menu structure
- Includes SENSOMASTER software for easy configuration of the tool
- 3 function modes: click-type, peak (indicating mode displaying peak reading) and track (indicating mode displaying current value)
- Data storage (\leq 2,500 tightening jobs)
- Acoustic and visual assessment of the joint
- Clockwise and anticlockwise tightening
- Tactile and acoustic trigger signals
- Torque and angle are simultaneously visible
- All readings are independent of the point of application of force with sizes 1, 2 and 4
- Display deviation value \pm 2% for torque and \pm 1% for angle

1

High-definition graphical colour display with additional side-mounted indicator lamps

2

Automatic key-lock prevents inadvertent changes

3

Fast, accurate setting via keypad

4

Own ident number can be stored in the wrench

5

Indicator lamps clearly visible from all sides
Yellow light: advance warning threshold reached
Green light: within the target range
Red light: reading is outside the tolerance range

6

In a sturdy plastic case with foam inlays (sizes 40-100 in steel case)
With certificate



Also available with adaptor for 22x28 mm

- Tighten large torques effortlessly
- High long-term durability
- 650 - 1000 N·m



No 7195-2



No 7160

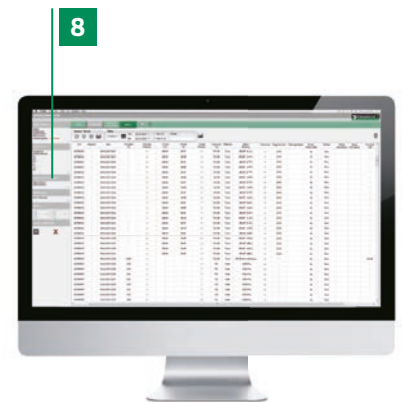

5



7 Optional extras: Li-Ionen battery No 7195-2 and charger No 7160

8 Individually configurable menus

9 Micro USB interface

10 Battery compartment with smooth-action bayonet fitting

11 Up to 200 joints can be programmed in up to 25 sequences

12 The wrench reminds the user automatically when calibration is due - either by the number of joints or the time interval



! Further details on page 202

MANOSKOP® 714 - indicating and click-type Electromechanical angle-controlled torque wrench

- 4 measuring modes (torque, angle, torque backed up by angle, angle backed up by torque)
- high-definition colour display with additional side-mounted indicator lamps
- freely configurable menu structure
- optionally: Li-ion battery No 7195-2 and charger No 7160
- 3 function modes: cut-out, peak hold (indicating mode with peak value) and track (indicating mode with current value)
- Micro USB interface
- bayonet connection for battery compartment
- QuickRelease safety lock change system for insert tools
- Data storage (≤ 2500 tightening jobs)
- as many as 200 joints can be programmed in up to 25 preset sequences.
- different tolerance limits can be set for each joint
- acoustic and visual assessment of the joint
- rapid, accurate setting via keypad
- the automatic keypad lock prevents inadvertent changes
- overload protection by means of acoustic and visual signals and a fail-safe system (clockwise)
- automatic notification of the next calibration date, either by the number of joints or the time interval
- fully automated calibrating and adjusting using the perfectControl calibrating and adjusting unit No 7794-2 (torque) or 7794-3 (torque and angle)
- units of measure: N·m, ft·lb, in·lb.
- tightening torque is automatically corrected if a deviating extension is entered
- immediately reusable after release
- clockwise and anticlockwise tightening - it may be necessary to refit the insert tool rotated through 180° for anticlockwise tightening in the cut-out mode
- tactile and acoustic trigger signal.
- torque and angle are simultaneously visible
- all readings are independent of the point of application of force (with sizes 1, 2 and 4)
- safe handling due to ergonomically designed handle (resistant to oils, grease, fuels, brake fluid and Skydrol)
- 3 certificates (torque indicating/clicking, angle)
- in sturdy plastic case (size 40-100 in steel case)
- design patent, patent
- supplied with SENSOMASTER 4 software, USB cable, 4 AAA/LR03 micro-batteries, 1.5 V. AAA, 1.2 V, micro NiMH rechargeable batteries can be used
- display resolution, angle 0.1°
- display deviation value, angle $\pm 1\%$, ± 1 digit
- display resolution, torque (≤ 60 N·m: 0.01 N·m; > 60 N·m: 0.1 N·m)
- display deviation value, torque $\pm 2\%$, ± 1 digit

209-215

5

714 MANOSKOP® tightening angle torque wrenches with mount for insert tools



2013

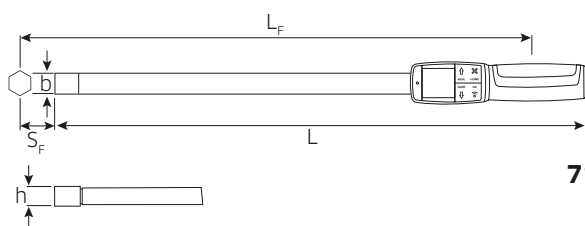

714/2



714/20



714/80



Code	size					b	h	L	L _F	S _F	$\Delta \varnothing$ g	$\Delta \varnothing$ g with box
		mm	mm	mm	mm	mm	mm	mm	mm	mm		
96 50 09 01	1	1-10 N·m	0.7-7.5 ft·lb	9-90 in·lb	9x12	28	23	226	188	17.5	370	795
96 50 09 02	2	2-20 N·m	1.5-15 ft·lb	18-180 in·lb	9x12	28	23	226	188	17.5	380	805
96 50 09 04	4	4-40 N·m	3-30 ft·lb	36-360 in·lb	9x12	28	23	252	214	17.5	420	845
96 50 09 06	6	6-60 N·m	4.5-45 ft·lb	54-540 in·lb	9x12	28	23	393	355	17.5	810	1235
96 50 09 10	10	10-100 N·m	7.4-75 ft·lb	90-900 in·lb	9x12	28	23	466	428	17.5	1085	1655
96 50 09 20	20	20-200 N·m	15-150 ft·lb	180-1800 in·lb	14x18	28	23	547	516	25	1361	1896
96 50 09 40	40	40-400 N·m	30-300 ft·lb	360-3600 in·lb	14x18	28	23	687	656	25	1765	5155
96 50 09 65	65	65-650 N·m	48-480 ft·lb	580-5800 in·lb	22x28	30.6	25.6	890	890	55	3222	7000
96 50 09 80	80	80-800 N·m	60-600 ft·lb	720-7200 in·lb	22x28	30.6	25.6	1158	1158	55	4572	10400
96 50 01 00	100	100-1000 N·m	74-750 ft·lb	900-9000 in·lb	22x28	30.6	25.6	1343	1343	55	4990	10500

714R MANOSKOP® tightening angle torque wrenches with reversible ratchet insert tool



Code	size							
		N·m	ft·lb	in·lb	mm	"	g	g with box
96 50 1001	1	1-10	0,7-7,5	9-90	9x12	1/4	432	857
96 50 1002	2	2-20	1,5-15	18-180	9x12	1/4	442	867
96 50 1004	4	4-40	3-30	36-360	9x12	1/4	482	907
96 50 1006	6	6-60	4,5-45	54-540	9x12	3/8	965	1390
96 50 1010	10	10-100	7,4-75	90-900	9x12	1/2	1232	1657
96 50 1020	20	20-200	15-150	180-1800	14x18	1/2	1663	2198
96 50 1040	40	40-400	30-300	360-3600	14x18	3/4	2275	5665
96 50 1065	65	65-650	48-480	580-5800	22x28	3/4	5137	9000
96 50 1080	80	80-800	60-600	720-7200	22x28	3/4	6487	12300
96 50 1100	100	100-1000	74-750	900-9000	22x28	3/4	6905	12500

7732-2 SENSMASER Live software

- Record torqueing operations with the MANOSKOP® 714, SENSOTORK® 713R (from firmware 4.x) and SENSOTORK® 701.
- Representation of torque over time, angle over time, torque over angle.
- Representation of several curves simultaneously.
- Data export for further processing.
- The software is for a single-seat licence.
- Torque wrenches 714/1 ... /100 must have firmware version 02.01.02.

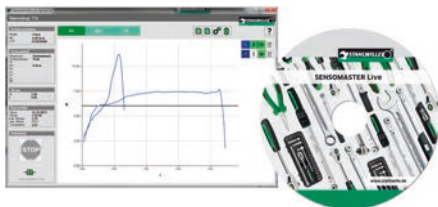

Code	
	g
96 58 52 35	111

7195-2 Li-ion battery for No 714

M charge voltage 4.2 V, capacity 2600 mAh
Warning - hazardous goods: Rechargeable cell block Li-ion for torque wrenches in accordance with UN 3480, Class 9



Code	
	g
54 10 11 95	100

7160 Charging dock for Li-ion battery No 7195-2

including charger
Input: 100 V-240 V AC,
Output: 4.2 V DC,
Charge duration: 4 hrs.
with interchangeable socket adaptors.



Code	
	g
54 10 00 60	200

7762 Docking station for No 714

stationary base for securely connecting angle-controlled torque wrench No 714 to a PC via a USB port.



Code	
	g
52 11 00 62	421



7762-1 Rest for docking station No 7762

for securely supporting long angle-controlled torque wrenches No 714 from size 6 up.



Code	
	g
52 11 01 62	520

7761/3 Interface adaptor set

required for automated calibration and adjustment of angle-controlled torque wrench No 714 using calibrating and adjusting units perfectControl No 7794-2 and 7794-3.

- Contents
No 7761 interface adaptor
No 7752 spiral cable
No 7760 mains adaptor



Code	
	g
96 52 11 61	446



Sensotork® 713R

Electronic angle-controlled torque wrench



Benefits at a glance:

- Backlit LC display
- Broad measuring range (5% - 100% of rated value)
- Extremely wide range of angle measurement
- Units of measurement N·m / ft·lb / in·lb
- Clockwise and anticlockwise use
- For use with all insert tools 9x12 and 14x18 mm
- QuickSelect rapid recall of predefined sets of operating parameters
- Defined sequence - a number of repeated joints can be grouped as a defined sequence
- Tightening jobs are stored with a timestamp
- Readings can either be directly stored, transmitted to the PC or simply displayed
- Password protection tamper proof use
- Freely selectable names for each series of test
- Various languages available
- Works-specific identifier
- Programmable via PC
- Resistant to oils, grease, fuels, brake fluids and Skydrol
- Wide range of application: -20°C to +60°C
- Meets requirements of DKD-R 3-7, Class 2
- Deviation of indication $\pm 1\%$

1





- 1** Backlit display improves legibility and evaluation of the tightening operation (traffic-light colours).
- 2** All functions are selected using the arrow keys. The visual guidance system makes operation a simple matter
- 3** Improved ergonomics for strain-free working. Measurements independent of the point of application of force.
- 4** Convenient angle measurement across a very wide angle range.
- 5** Warning signals: acoustic (buzzer), tactile (vibration in the handle), visual (LEDs and display). The point at which the warning signal is triggered can be freely set
- 6** Data output USB interface
- 7** Easy extension setting. Where the insert tool requires an extension adjustment, simply enter the new value. Recalculation using complicated formulae is no longer necessary
- 8** QuickRelease Firm locking and rapid change of any insert tools

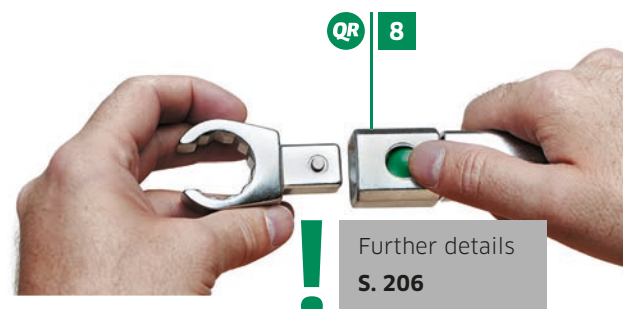

Further details
S. 206

Electronic angle-controlled torque wrenches SENSOTORK® 713R

- simple, flexible operation thanks to operator guidance on large-format display
- very broad measuring range (5% to 100% of rated value)
- supplied with insert tool reversible ratchet
- more insert tools
- QuickRelease safety lock
- for clockwise and anticlockwise torquing
- measurements independent of the point of application of force
- units of measurement: N·m, ft·lb, in·lb
- advance warning points programmable for visual, tactile and acoustic signals
- torque and angle are simultaneously visible
- new: backlit display aids evaluation of the tightening operation (traffic-light colours).
- insert tool lengths can be individually set
- maintenance friendly due to easy adjustment and automatic reminder of next calibration date
- repeated joints can be collated to form a single menu-guided sequence
- new: tightening jobs are stored with a timestamp
- individual identification markings possible
- password protection to prevent inadvertent changes and make the tool tamper-proof
- meets requirements of DKD-R 3-7, Class 2
- with certificate
- in sturdy plastic case (size 40 in tough steel case)
- supplied with two 1.5 V AA batteries. AA/LR6, 1.2 V NiMH rechargeable cells may also be used.
- fully automated calibration (torque) using perfectControl calibrating unit No 7794-2.
- registered design
- display deviation value for angle $\pm 1^\circ$
- display deviation value $\pm 1\%$

209-215

5

713R

Electronic SENSOTORK® tightening angle torque wrenches with reversible ratchet insert tool

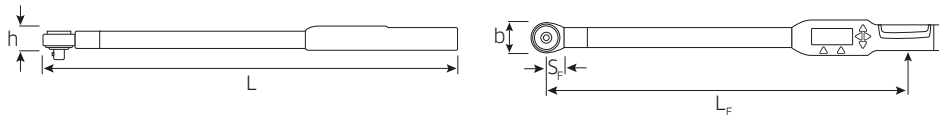

Code	size				"	mm	b mm	h mm	L mm	L _F mm	S _F mm	Δ g	Δ g with box
96 50 16 06	6	3-60 N·m	2.5-44 ft·lb	27-540 in·lb	3/8	9x12	33	24	378	299	17.5	856	1500
96 50 16 20	20	10-200 N·m	7-148 ft·lb	90-1800 in·lb	1/2	14x18	43	26	608	524	25	1552	2430
96 50 16 40	40	20-400 N·m	15-296 ft·lb	180-3600 in·lb	3/4	14x18	50	31.5	838	750	25	2332	5555

Electronic torque wrench SENSOTORK® 712R

712R/6

Electronic SENSOTORK® torque wrench with reversible ratchet insert tool

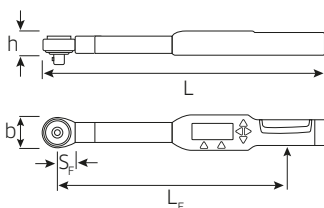

Code	size				"	mm	b mm	h mm	L mm	L _F mm	S _F mm	Δ g	Δ g with box
96 50 15 06	6	3-60 N·m	2.5-44 ft·lb	27-540 in·lb	3/8	9x12	33	24	378	299	17.5	856	1500

Accessories for electronic angle-controlled torque wrench Sensotork® No 713R and electronic torque wrench SENSOTORK® No 712R

7759-5 USB hub, jack cable and SENSOMASTER 4 software

NEW

- SENSOMASTER 4 - one software package for all electronic torque wrenches from STAHLWILLE
- Self-explanatory thanks to intuitive GUI with clearly organised tabbed layout
- Quick and easy programming for electronic torque wrenches
- Enables comprehensive evaluations, for example in connection with quality assurance
- Read out stored wrench data and joint readings: Joint identifier, Tool serial number, Date and time of tightening operation, Target torque or target angle, Torque level at which the tool cuts out, Tightening torque or angle reached, Tolerances, Joint evaluation
- Storage of joint data in a database
- Delete or print highlighted joints from the database
- Export displayed joint data to a range of file formats (*.XLS;*.CSV;*.ODG)
- User management
- Define new PIN
- Delete joint data stored in wrench

System requirements:

- PC
- From Microsoft Windows XP on
- USB connection

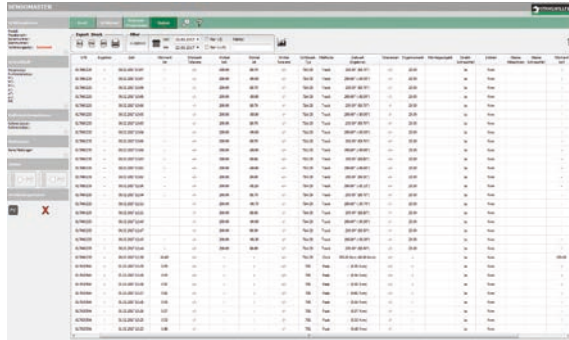

Code	L m	⚖ g
96 58 36 30	1.5	137

7757-1 USB adaptor



Code	⚖ g
52 11 10 57	10

7751 Jack cable

with jacks at both ends, 90° angled.



Code	L m	⚖ g
52 11 00 51	1.5	50

SENSOTORK® 713R.

The decisive moment. Improved.



Accessories

7301/7302 Plastic case, empty

for safe storage and transport of torque wrenches (please order inlays separately). Supplied without torque wrench.



Code	No	for torque wrenches No	L mm	Δ g
81 37 0002	7301	712R/6; 713R/6; 714/1-10; 721/5-20 Quick; 730/5-20 Quick; 730/5-20 Fix; 730N/5-20; 730D/10	550	425
81 37 0003	7302	713R/20; 714/20; 721/30 Quick; 730/40 Quick; 730/40 Fix; 730N/40; 730D/20	680	535

7303/7304 Inlays for plastic case

Code	No	for torque wrenches No	Δ g
83 07 1004	7303	712R/6; 713R/6; 721/5-20 Quick; 730/5-20 Quick; 730/5-20 Fix; 730N/5-20; 730D/10	88
83 07 1002	7304	713R/20; 721/30 Quick; 730/40 Quick; 730/40 Fix; 730N/40; 730D/20	113

TWBE 65-100 Textile bags for larger torque wrenches

For safe storage and transport of large torque wrenches

NEW



Code	No	for torque wrenches No	Δ g
81 23 11 00	TWBE 65	714/65; 730/65 Quick; 730II/65 Quick; 730N/65; 730NII/65; 730/65 Fix; 730II/65 Fix; 730D/65; 730DII/65	670
81 23 11 01	TWBE 80	714/80; 71/80; 71aR/80; 720Nf/80; 721Nf/80; 730/80; 730D/80	714
81 23 11 02	TWBE 100	714/100; 730N/80; 730/80 Fix; 730N/100; 730D/100	760
81 23 11 03	TWBE 721NF/100	721Nf/100	850

7380N/7385N Torque angle gauges

for angle controlled bolt/screw tightening, with static read-off point. Read-off possible from any angle thanks to a pair of angled scales.

Removable magnet for attaching sockets with 1/2" internal square drive. For use in conjunction with tightening tools such as Service MANOSKOP® No 730N.

Since this tightening method requires a pre-determined snug torque to be applied, it is essential to choose a torque wrench covering both snug torque as well as maximum torque required to reach the recommended tightening angle. Whether 1/2" or 3/4" sq.dr.

Torque Angle Gauge is used depends upon the square drive of the appropriate torque wrench employed.

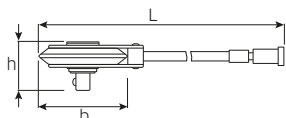

Code	No	□	■	mm	b	h	L	Δ g	
54 01 00 01	7380N	1/2	1/2	± 360°	2°	78	43	416	494
54 01 00 02	7385N	3/4	3/4	± 360°	2°	78	76	416	720

7161 QuickRelease safety lock

prevents insert tools being swapped. The system is locked in place on the head of the torque wrench by means of a safety screw. Once the protection system has been fitted, it is possible to attach an insert tool but not to remove it because the QuickRelease unlock button itself is locked. After the safety screw has been removed, the torque wrench reverts to being a standard, versatile tool.



The safety screw can be fitted and removed using a TORX® screwdriver with a central bore in the tip (No 4656, Size T20, Code 46 56 00 20) or a BITS screwdriver insert with a central bore in the tip (No 1442, Size T20, Code 08 16 00 20).

Code	size	for torque wrenches No	Δ g
54 10 00 70	1	714/1-4	4
54 10 00 71	2	712R/6; 713R/6; 714/6-10; 730/10 Quick; 730/10 Fix; 730N/10; 730D/10	5
54 10 00 72	3	713R/20-40; 714/20-40; 730/12-40 Quick; 730/12-40 Fix; 730N/12-40; 730D/20-40	11
54 10 00 73	4	730/5 Quick; 730/5 Fix; 730N/5	2
54 10 00 74	5	714/65-100; 730II/65; 730II/65 Quick; 730II/65 Fix; 730/80-100 Fix; 730NII/65; 730N/80-100; 730DII/65; 730D/80-100	15

for other torque wrenches on request.

7396 LED lighting

for torque wrenches
If light is poor, simply attach this LED lamp to illuminate the work site. Included in the delivery is a 1.5 V micro battery. Supplied without torque wrench.



Code	for torque wrenches No	Δ g
54 01 00 04	712R/6; 713R/6-40; 714/6-40; 721/5-30 Quick; 730/5-40 Quick; 730/5-40 Fix; 730N/5-40; 730D/10-40	51

1299 BIT

for inside hexagon screws, for operating the adjusting screws on torque wrenches No 720, 721, 730 and 730N.



Code	mm	outside mm	"	L mm	Δ g	box
08 09 00 02	2	C 6.3	1/4	34	4	10

outside ● DIN 3126/ISO 1173

Insert/shell tools for torque wrenches

Output square drive in accordance with DIN 3120

Long-term loading of the input and output square drive is in accordance with DIN EN ISO 6789.

This limit must not be exceeded if larger torque wrenches and tool holders are used.

725QR QuickRelease ratchet insert tools

QR

reversible, with QuickRelease safety lock, size 4: 22 teeth, sizes 5 and 10: 30 teeth

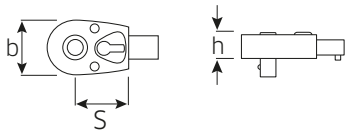

Code	size	"	mm	b mm	h mm	S mm	max. N·m	ΔΔ g
58 25 3004	4	1/4	9x12	22	13.8	17.5	40	60
58 25 3005	5	3/8	9x12	29	18	28*	100	130
58 25 3010	10	1/2	9x12	29	18	28*	100	141

* Caution! Modified settings on torque wrench (refer to note on page 187).

725B Bit ratchet insert tool

reversible, with inside hexagon, 1/4" or 5/16", DIN 3126/ISO 1173 D 6.3 or D8, for direct acceptance of bits 1/4" or 5/16" outside hexagon C 6.3 (size 4: 22 teeth, size 5: 30 teeth). Internal hex drive with a collar-thrust spring. Bits are easy to insert, lock securely in position and can be removed just as easily; even hex bits with a wide groove (Type E, DIN 3126/ISO 1173). Supplied without bits.

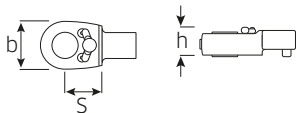

Code	size	inside "	mm	b mm	h mm	S mm	max. N·m	ΔΔ g
58 25 5004	4	1/4	9x12	22	13.6	17.5	40	54
58 25 5005	5	5/16	9x12	29	17.9	28*	100	117

* Caution! Modified settings on torque wrench (refer to note on page 187).

725/4 Ratchet insert tool

reversible, 22 teeth.

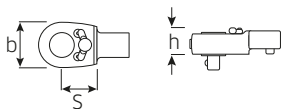

Code	"	mm	b mm	h mm	S mm	max. N·m	ΔΔ g
58 25 4004	1/4	9x12	22	13.8	17.5	40	62

735 Ratchet insert tools, fine tooth

reversible, 60 teeth.

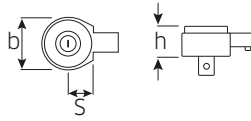

Code	size	"	mm	b mm	h mm	S mm	max. N·m	ΔΔ g
58 25 0005	5	3/8	9x12	33	24	17.5	100	155
58 25 0010	10	1/2	9x12	33	24	17.5	100	147

734 Square drive insert tools

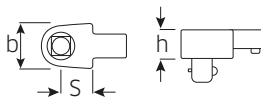

Code	size	"	mm	b mm	h mm	S mm	max. N·m	ΔΔ g
58 24 0004	4	1/4	9x12	20	14	17.5	40	71
58 24 0005	5	3/8	9x12	20	14	17.5	80	76
58 24 0010	10	1/2	9x12	20	14	17.5	100	82

734F Square drive insert tools

with permanently attached, captive square drive.

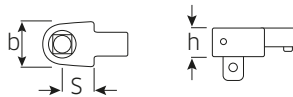

Code	size	"	mm	b mm	h mm	max. N·m	ΔΔ g
58 24 1004	4	1/4	9x12	22	14	40	72
58 24 1005	5	3/8	9x12	22	14	80	75

725L/5 Ratchet insert tool

reversible, 30 teeth.

Caution! Modified settings on torque wrench (refer to note on p. 187). This ratchet insert tool has the same extension length as ring insert tool No 732G/10 (see p. 211) and square drive insert tool No 734L/5 (see p. 210).

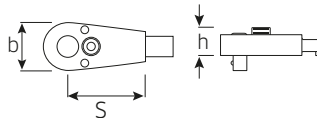

Code	"	mm	b mm	h mm	max. N·m	ΔΔ g
58 15 1005	3/8	9x12	27.5	19.6	100	164

Insert/shell tools

734L/5 Square drive insert tool

Caution! Modified settings on torque wrench (refer to note on p. 187). This square-drive insert tool has the same extension length as ring insert tool No 732G/10 (see p. 211) and ratchet insert tool No 725L/5 (see p. 209).

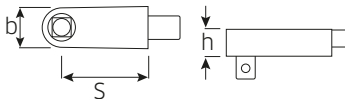

Code	"	mm	b mm	h mm	max. N·m	Δ g
58 24 2005	3/8	9x12	20	14	80	141

731/10 Open ended insert tools

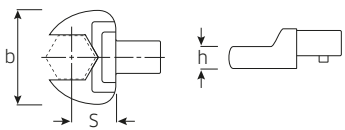

Code	mm	mm	b mm	h mm	S mm	Δ g
58 21 1007	7	9x12	22	5	17.5	40
58 21 1008	8	9x12	22	5	17.5	39
58 21 1009	9	9x12	26	5.5	17.5	38
58 21 1010	10	9x12	26	5.5	17.5	42
58 21 1011	11	9x12	26	5.5	17.5	41
58 21 1012	12 ¹⁾	9x12	30	7	17.5	43
58 21 1013	13	9x12	30	7	17.5	48
58 21 1014	14	9x12	35	8	17.5	52
58 21 1015	15	9x12	35	8	17.5	51
58 21 1016	16	9x12	38	8.5	17.5	58
58 21 1017	17	9x12	38	8.5	17.5	60
58 21 1018	18	9x12	42	9	20*	71
58 21 1019	19	9x12	42	9	20*	74

¹⁾ For flare nuts of hydraulic pipes on French vehicles

731a/10 Open ended insert tools

Code	"	mm	b mm	h mm	S mm	Δ g
58 61 1016	1/4	9x12	22	5	17.5	36
58 61 1020	5/16	9x12	22	5	17.5	53
58 61 1024	3/8	9x12	26	5.5	17.5	38
58 61 1028	7/16	9x12	26	5.5	17.5	37
58 61 1032	1/2	9x12	30	7	17.5	44
58 61 1034	9/16	9x12	35	8	17.5	49
58 61 1036	5/8	9x12	38	8.5	17.5	64
58 61 1038	11/16	9x12	42	9	20*	76
58 61 1040	3/4	9x12	42	9	20*	73

* Caution! Modified settings on torque wrench (refer to note on page 187).

732/10 Ring insert tools

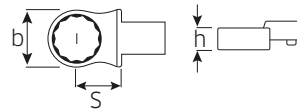

Code	mm	mm	b mm	h mm	S mm	Δ g
58 22 1007	7	9x12	13	8	17.5	37
58 22 1008	8	9x12	14.2	8	17.5	40
58 22 1010	10	9x12	17.2	9	17.5	44
58 22 1011	11	9x12	18.5	9	17.5	41
58 22 1012	12	9x12	20.5	11	17.5	49
58 22 1013	13	9x12	21.5	11	17.5	55
58 22 1014	14	9x12	22.5	11	17.5	52
58 22 1015	15	9x12	24.5	12	17.5	52
58 22 1016	16	9x12	26	12	17.5	54
58 22 1017	17	9x12	27	13	17.5	59
58 22 1018	18	9x12	28	13	17.5	56
58 22 1019	19	9x12	30.5	13	17.5	65
58 22 1021	21	9x12	33	15	17.5	71
58 22 1022	22	9x12	34.5	15	17.5	74

732a/10 Ring insert tools



Code	"	mm	b mm	h mm	S mm	Δ g
58 62 1016	1/4	9x12	13	8	17.5	36
58 62 1020	5/16	9x12	14.2	8	17.5	37
58 62 1024	3/8 ¹⁾	9x12	17.2	9	17.5	37
58 62 1028	7/16	9x12	18.5	9	17.5	40
58 62 1032	1/2	9x12	21.5	11	17.5	53
58 62 1034	9/16	9x12	22.5	11	17.5	52
58 62 1036	5/8	9x12	26	12	17.5	54
58 62 1038	11/16	9x12	28	13	17.5	58
58 62 1040	3/4	9x12	30.5	13	17.5	58
58 62 1042	13/16	9x12	33	15	17.5	68
58 62 1044	7/8	9x12	34.5	15	17.5	69

¹⁾ For Volvo aero-engines, types "JAS"

732TX/10 TORX® insert tools

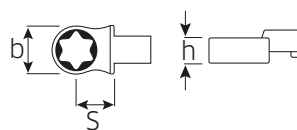

Code	size	mm	b mm	h mm	S mm	Δ g
58 29 1006	E6	9x12	13	8	17.5	40
58 29 1008	E8	9x12	14.2	8	17.5	45
58 29 1010	E10	9x12	17.2	9	17.5	45
58 29 1012	E12	9x12	18.5	9	17.5	50
58 29 1014	E14	9x12	21.5	11	17.5	60

732G/10 Ring insert tools



Caution! Modified settings on torque wrench (refer to note on p. 187). This insert tool has the same extension length as insert tool No 725L/5 (see p. 209) and square-drive insert tool No 734L/5 (see p. 210); HPQ® high performance steel, gunmetal finish.

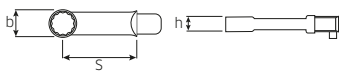

Code	mm	mm	b mm	h mm	S mm	Δg
58 62 00 07	7	9x12	11.5	6	45	31
58 62 00 08	8	9x12	12.4	6	45	33
58 62 00 09	9	9x12	14	8	45	40
58 62 00 10	10	9x12	15.6	8	45	44
58 62 00 13	13	9x12	19.3	9.2	45	60

732aG/10 Ring insert tools

Code	"	mm	b mm	h mm	S mm	Δg
58 62 12 16	1/4	9x12	10.4	6	45	28
58 62 12 20	5/16	9x12	12.4	6	45	31
58 62 12 24	3/8	9x12	14.9	8	45	42
58 62 12 28	7/16	9x12	17	8	45	43
58 62 12 32	1/2	9x12	19	9.2	45	58
58 62 12 34	9/16	9x12	21	9.2	45	58
58 62 12 36	5/8	9x12	23	12	45	74

for assembling and dismantling aero-engines.

733/10 Open ring insert tools

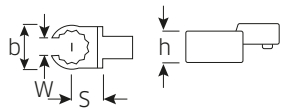

Code	mm	mm	b mm	h mm	W mm	S mm	Δg
58 23 10 10	10	9x12	21.5	11	7.1	17.5	57
58 23 10 11	11	9x12	22.5	11	8.6	17.5	55
58 23 10 12	12	9x12	24.5	12	9	17.5	59
58 23 10 13	13	9x12	26	12	10	17.5	55
58 23 10 14	14	9x12	27	13	11	17.5	60
58 23 10 16	16	9x12	30.5	13	13	17.5	65
58 23 10 17	17	9x12	31.5	13	14	17.5	64
58 23 10 18	18	9x12	33	15	14.8	17.5	74
58 23 10 19	19	9x12	34	15	15.8	17.5	80
58 23 10 21	21	9x12	38.5	15	16.2	20*	88
58 23 10 22	22	9x12	39.5	15	17	20*	92
58 23 10 24	24	9x12	40	15	18	20*	75

* Caution! Modified settings on torque wrench (refer to note on page 187)

733a/10 Open ring insert tools



Code	"	mm	b mm	h mm	W mm	S mm	Δg
58 63 10 24	3/8	9x12	21.5	11	7.1	17.5	55
58 63 10 28	7/16	9x12	22.5	11	8.6	17.5	56
58 63 10 32	1/2	9x12	26	12	9.5	17.5	58
58 63 10 34	9/16	9x12	27.5	13	11	17.5	59
58 63 10 36	5/8	9x12	30.5	13	12.7	17.5	61
58 63 10 38	11/16	9x12	33	15	14	17.5	48
58 63 10 40	3/4	9x12	34	15	15.8	17.5	76

736 BIT holder insert tools

Internal hex drive with a collar-thrust spring. Bits are easy to insert, lock securely in position and can be removed just as easily; even hex bits with a wide groove (Type E, DIN 3126/ISO 1173).

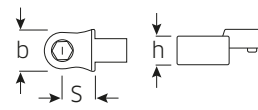

Code	size	inside	mm	b mm	h mm	S mm	Δg
58 26 10 10	10	D 8	5/16	9x12	16	12.5	17.5
58 26 26 10	10-1	D 6.3	1/4	9x12	14	10	17.5

inside ○ DIN 3126/ISO 1173

737/10 Blank end insert tool

gunmetal finish. To prevent damage from excessive temperatures, the locking pin, spring and washer are not fitted until the welding work has been completed. Instructions are supplied.

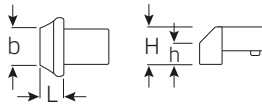

Code	Welding surface	mm	H mm	L mm	Δg
58 27 00 10	h x b in mm	9x12	14.5	8	35

7370/10 Adaptor



for using insert tools with an outer square drive of 14 x 18 mm on torque wrenches with an internal square drive of 9 x 12 mm. Caution! Modified settings on torque wrench (refer to note on p. 187).

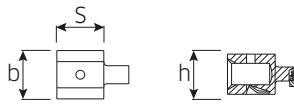

Code	mm	mm	b mm	h mm	S mm	Δg
58 29 00 10	9x12	14x18	31	26	30.5	114

7370/10-2 Adaptor

for use with insert tools with a lateral dovetail profile in torque wrenches with 9 x 12 mm internal square drives. Caution! Modified settings on torque wrench (refer to note on p. 187).

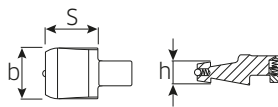

Code	mm	b mm	h mm	S mm	Δg
58 29 00 12	9x12	23.5	9.5	24	51

1820 Tool holder

with tool carrier to receive insert/shell tools (without torque function).



Code	mm	L mm	Δg
18 20 00 01	9x12	382.5	490

Insert/shell tools

725QR/20 QuickRelease ratchet insert tool

QR

reversible, with QuickRelease safety lock, 36 teeth.

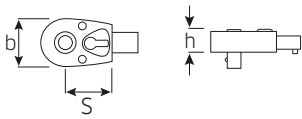

Code	size	"	mm	b mm	h mm	S mm	max. N·m	Δ g
58 25 30 20	20	1/2	14x18	41	22.3	38.5*	200	325

* Caution! Modified settings on torque wrench (refer to note on page 187).

735 Ratchet insert tools, fine tooth

reversible, 60 teeth.

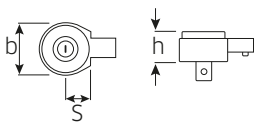

Code	size	"	mm	b mm	h mm	S mm	max. N·m	Δ g
58 25 00 20	20	1/2	14x18	43	26	25	300	302
58 25 00 40	40	3/4	14x18	50	31.5	25	400	510
58 25 00 65	40HD	3/4	14x18	58	36	30*	650	737

* Caution! Modified settings on torque wrench (refer to note on page 187).

734 Square drive insert tools

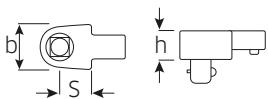

Code	size	"	mm	b mm	h mm	S mm	max. N·m	Δ g
58 24 00 20	20	1/2	14x18	27	18	25	300	203
58 24 00 40	40	3/4	14x18	40	25	25	650	396

731/40 Open ended insert tools

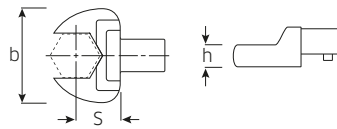

Code	"	mm	b mm	h mm	S mm	Δ g
58 21 40 13	13	14x18	30	7	25	128
58 21 40 14	14	14x18	35	8	25	129
58 21 40 15	15	14x18	35	8	25	132
58 21 40 16	16	14x18	38	9	25	140
58 21 40 17	17	14x18	38	9	25	136
58 21 40 18	18	14x18	42	10	25	147
58 21 40 19	19	14x18	42	10	25	145
58 21 40 21	21	14x18	50	11	25	171
58 21 40 22	22	14x18	50	11	25	165
58 21 40 24	24	14x18	53	12	25	167
58 21 40 25	25	14x18	53	12	25	170
58 21 40 27	27	14x18	60	13	30*	219
58 21 40 30	30	14x18	66	14	30*	245
58 21 40 32	32	14x18	66	14	32.5*	246
58 21 40 34	34	14x18	66	14	32.5*	239
58 21 40 36	36	14x18	74	15	32.5*	275
58 21 40 38	38	14x18	74	15	32.5*	265
58 21 40 41	41	14x18	82	15	36.5*	307

* Caution! Modified settings on torque wrench (refer to note on page 187).

731a/40 Open ended insert tools

Code	"	mm	b mm	h mm	S mm	Δ g
58 61 40 28	7/16	14x18	30	7	25	127
58 61 40 32	1/2	14x18	30	7	25	125
58 61 40 34	9/16	14x18	35	8	25	129
58 61 40 36	5/8	14x18	38	9	25	136
58 61 40 38	11/16	14x18	42	10	25	148
58 61 40 40	3/4	14x18	42	10	25	144
58 61 40 42	13/16	14x18	50	11	25	171
58 61 40 44	7/8	14x18	50	11	25	165
58 61 40 46	15/16	14x18	53	12	25	177
58 61 40 48	1	14x18	60	13	30*	224
58 61 40 52	1 1/8	14x18	66	14	30*	258

* Caution! Modified settings on torque wrench (refer to note on page 187).

STAHLWILLE insert tools.
More diversity. More options.



732/40 Ring insert tools

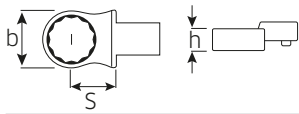

Code	mm	mm	b mm	h mm	S mm	Δ g
58 22 40 13	13	14x18	22.5	11	25	130
58 22 40 14	14	14x18	23	11	25	123
58 22 40 15	15	14x18	24	11	25	128
58 22 40 16	16	14x18	25.5	12	25	133
58 22 40 17	17	14x18	27	12	25	135
58 22 40 18	18	14x18	29	13	25	134
58 22 40 19	19	14x18	30.5	13	25	138
58 22 40 21	21	14x18	33	15	25	144
58 22 40 22	22	14x18	34.5	15	25	145
58 22 40 24	24	14x18	37.5	15	25	153
58 22 40 27	27	14x18	42.5	17	25	162
58 22 40 28	28	14x18	45.5	19	25	175
58 22 40 30	30	14x18	46	19	25	182
58 22 40 32	32	14x18	47.5	19	25	181
58 22 40 34	34	14x18	52	19	28*	210
58 22 40 36	36	14x18	54	19	28*	203
58 22 40 41	41	14x18	60	20	30*	240

* Caution! Modified settings on torque wrench (refer to note on page 187)

732a/40 Ring insert tools



Code	"	mm	b mm	h mm	S mm	Δ g
58 62 40 32	1/2	14x18	22.5	11	25	122
58 62 40 34	9/16	14x18	23	11	25	122
58 62 40 36	5/8	14x18	25.5	12	25	134
58 62 40 38	11/16	14x18	29	13	25	132
58 62 40 40	3/4	14x18	30.5	13	25	138
58 62 40 42	13/16	14x18	33	15	25	142
58 62 40 44	7/8	14x18	34.5	15	25	147
58 62 40 46	15/16	14x18	37.5	15	25	151
58 62 40 48	1	14x18	41	17	25	160

732TX/40 TORX® insert tools

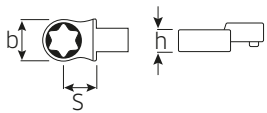

Code	size	mm	b mm	h mm	S mm	Δ g
58 29 40 14	E14	14x18	22.5	11	25	130
58 29 40 18	E18	14x18	24	11	25	135
58 29 40 20	E20	14x18	29	13	25	150
58 29 40 24	E24	14x18	30.5	13	25	150

7370/40-1 Adaptor

for using shell tools with an internal square drive of 24.5 x 28 mm on torque wrenches with an internal square drive of 14 x 18 mm. Caution! Modified settings on torque wrench (refer to note on p. 187).



Code	mm	mm	L mm	Δ g
58 29 00 41	14x18	24,5x28	66	251

736/40 BIT holder insert tool

Internal hex drive with a collar-thrust spring. Bits are easy to insert, lock securely in position and can be removed just as easily; even hex bits with a wide groove (Type E, DIN 3126/ISO 1173).



Code	inside	"	mm	b mm	h mm	S mm	Δ g
58 26 10 40	D 8	5/16	14x18	16	12.5	25	112

inside ○ DIN 3126/ISO 1173

737/40 Blank end insert tool

gunmetal finish. To prevent damage from excessive temperatures, the locking pin, spring and washer are not fitted until the welding work has been completed. Instructions are supplied.

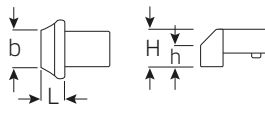

Code	Welding surface	mm	H mm	L mm	Δ g
58 27 00 40	h x b in mm	14x18	21.5	12	98

7370/40 Adaptor



for using insert tools with an outer square drive of 9 x 12 mm on torque wrenches with an internal square drive of 14 x 18 mm. Caution! Modified settings on torque wrench (refer to note on p. 187).

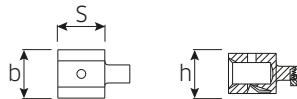

Code	mm	mm	b mm	h mm	S mm	Δ g
58 29 00 40	14x18	9x12	28	21	21.5	115

7370/40-2 Adaptor

for use with insert tools with a lateral dovetail profile in torque wrenches with 14 x 18 mm internal square drives. Caution! Modified settings on torque wrench (refer to note on p. 187).

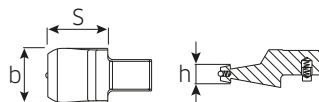

Code	mm	b mm	h mm	S mm	Δ g
58 29 00 42	14x18	31.5	9.5	34.6	138

1821 Tool holder

with tool carrier to receive insert/shell tools (without torque function).



Code	mm	L mm	Δ g
18 21 00 01	14x18	575	720

Insert/shell tools

735/65 Ratchet insert tool, fine tooth

reversible, 60 teeth, load capacity up to 650 N-m, for size 65 torque wrenches.

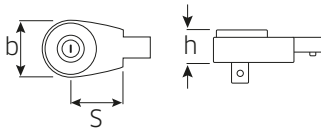

Code	"	mm	b mm	h mm	S mm	Δg
58 25 10 65	3/4	22x28	61	35	55	1100

735/100 Ratchet insert tool

with push through square drive, 30 teeth.

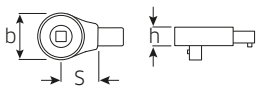

Code	"	mm	b mm	h mm	S mm	Δg
58 25 01 00	3/4	22x28	76	42	55	1893

734/100 Square drive insert tool

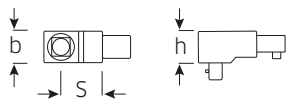

Code	"	mm	b mm	h mm	S mm	Δg
58 24 01 00	3/4	22x28	43	42	55	1171

731/100 Open ended insert tools

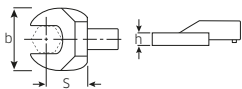

Code	mm	mm	b mm	h mm	S mm	Δg
58 21 10 24	24	22x28	50	13	55	628
58 21 10 27	27	22x28	56	14	55	648
58 21 10 30	30	22x28	63	15	55	695
58 21 10 32	32	22x28	67	15	55	713
58 21 10 34	34	22x28	72	15	55	739
58 21 10 36	36	22x28	74	15	55	727
58 21 10 41	41	22x28	84	16	55	902
58 21 10 46	46	22x28	94	17	55	952
58 21 10 50	50	22x28	104	18	55	1074
58 21 10 55	55	22x28	114	19	55	1174
58 21 10 60	60	22x28	124	20	55	1230

732/100 Ring insert tools

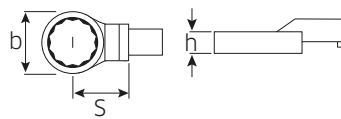

Code	mm	mm	b mm	h mm	S mm	Δg
58 22 10 24	24	22x28	43	15	55	629
58 22 10 27	27	22x28	43	15	55	619
58 22 10 30	30	22x28	46	16	55	632
58 22 10 32	32	22x28	49	16	55	625
58 22 10 34	34	22x28	52	17	55	638
58 22 10 36	36	22x28	54	17	55	631
58 22 10 41	41	22x28	61	18	55	642
58 22 10 46	46	22x28	66	19	55	640
58 22 10 50	50	22x28	75	20	55	713
58 22 10 55	55	22x28	84	21	55	791
58 22 10 60	60	22x28	93	22	55	885

737/100 Blank end insert tool

gunmetal finish. To prevent damage from excessive temperatures, the locking pin, spring and washer are not fitted until the welding has been completed. Instructions are supplied.

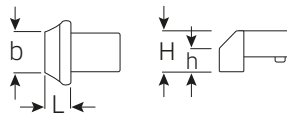

Code	Welding surface h x b in mm	mm	H mm	L mm	Δg
58 27 01 00	15 x 50	22x28	32	24	521

7370/100 Adaptor

for using shell tools with an internal square drive of 24.5 x 28 mm on torque wrenches with an internal square drive of 22 x 28 mm. Caution! Modified settings on torque wrench (refer to note on p. 187).



Code	mm	mm	L mm	S mm	Δg
58 29 11 00	22x28	24,5x28	85	100	563

735/80 Ratchet shell tool

with push through square drive, 30 teeth.

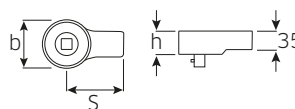

Code	"	mm	b mm	h mm	S mm	Δg
58 25 00 80	3/4	24,5x28	76	43	95	2000

734/80 Square drive shell tool

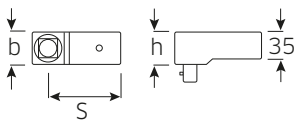

Code	"	mm	b mm	h mm	S mm	Δg
58 24 00 80	3/4	24,5x28	42	42	95	1200

731/80 Open ended shell tools

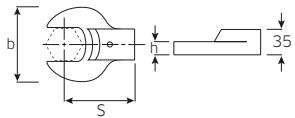

Code	mm	mm	b mm	h mm	S mm	Δg
58 21 80 24	24	24,5x28	50	13	95	601
58 21 80 27	27	24,5x28	56	14	95	620
58 21 80 30	30	24,5x28	63	15	95	655
58 21 80 32	32	24,5x28	67	15	95	670
58 21 80 34	34	24,5x28	72	15	95	699
58 21 80 36	36	24,5x28	74	15	95	740
58 21 80 41	41	24,5x28	84	16	95	810
58 21 80 46	46	24,5x28	94	17	95	867
58 21 80 50	50	24,5x28	104	18	95	1010
58 21 80 55	55	24,5x28	114	19	95	1150
58 21 80 60	60	24,5x28	124	20	95	1330

732/80 Ring shell tools

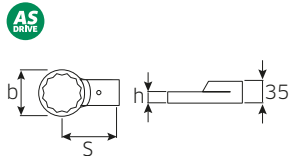

Code	mm	mm	b mm	h mm	S mm	Δg
58 22 80 24	24	24,5x28	36	15	95	605
58 22 80 27	27	24,5x28	40,5	15	95	610
58 22 80 30	30	24,5x28	46	16	95	630
58 22 80 32	32	24,5x28	49	16	95	635
58 22 80 34	34	24,5x28	52	17	95	650
58 22 80 36	36	24,5x28	54	17	95	650
58 22 80 41	41	24,5x28	61	18	95	675
58 22 80 46	46	24,5x28	66	19	95	720
58 22 80 50	50	24,5x28	75	20	95	803
58 22 80 55	55	24,5x28	84	21	95	889
58 22 80 60	60	24,5x28	93	22	95	995

732a/80 Ring shell tools

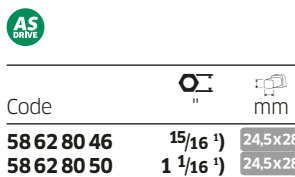

Code	"	mm	b mm	h mm	S mm	Δg
58 62 80 46	15/16 ¹⁾	24,5x28	36	14	95	604
58 62 80 50	1 1/16 ¹⁾	24,5x28	40,5	14	95	608

¹⁾ for jet engine pins (Airbus A320/A321)

7370/80 Shell adaptor

for attaching 14 x 18 mm insert tools.
Caution! Modified settings on torque wrench (refer to note on p. 187).

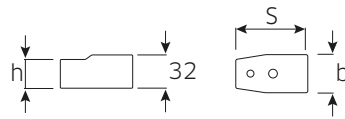

Code	mm	mm	b mm	h mm	S mm	Δg
58 29 00 80	24,5x28	14x18	36	26	70	281

1822 Tool holder

with tool carrier to receive insert/shell tools (without torque function).



Code	mm	L mm	Δg
18 22 00 03	24,5x28	1000	2000

540a HD CROW-FOOT spanners Heavy Duty

For particularly high loadings, e.g. stainless steel screw fittings.
Full use of jaws in conjunction with standard ratchets.
Caution! Modified settings on torque wrench (refer to note on page 187),
chrome plated. Supplied without ratchet.



Code	"	"	L mm	b mm	a mm	S mm	Δg	
02 50 10 24 NEW	3/8	3/8	39	26	11	24	58	1
02 50 10 28 NEW	7/16	3/8	40	26	11	25	58	1
02 50 10 32 NEW	1/2	3/8	42	30	11	25,8	67	1
02 50 10 34	9/16	3/8	43,4	32	11	26,8	52	1
02 50 10 36	5/8	3/8	45	34,8	11	27,7	58	1
02 50 10 38	11/16	3/8	47,2	38	11	28,6	69	1
02 50 10 40 NEW	3/4	3/8	49	41	11	29,6	96	1
02 50 10 42	13/16	3/8	51	46,4	11	30,5	113	1
02 50 10 44	7/8	3/8	52	48	11	31,3	99	1
02 50 10 46	15/16	3/8	54	51,2	11	32,3	129	1
02 50 10 48	1	3/8	56	53,4	11	33,2	133	1
02 50 10 50	1 1/16	3/8	57	53,8	11	34,1	124	1
02 50 10 52	1 1/8	3/8	59	53,8	11	35	128	1
02 50 10 54 NEW	1 3/16	3/8	60	56	11	35,9	148	1
02 50 10 56	1 1/4	3/8	62	60	11	36,8	153	1
02 50 10 58 NEW	1 5/16	3/8	63	56	11	27,9	160	1
02 50 10 60 NEW	1 3/8	3/8	65	62	11	38,7	180	1
02 50 10 62	1 7/16	3/8	66,5	66	11	39,6	172	1
03 50 10 64	1 1/2	1/2	76	70	16	45	310	1
03 50 10 69	1 13/16	1/2	85	84	16	49,6	400	1
03 50 10 72	2	1/2	89	90	16	52,3	451	1
03 50 10 74	2 1/8	1/2	91,5	92,8	16	54,2	460	1
03 50 10 75	2 3/16	1/2	93	96	16	55,1	480	1
03 50 10 76	2 1/4	1/2	95	99	16	56	500	1

Insert/shell tools

440

CROW-RING spanners



Caution! Modified settings on torque wrench (refer to note on page 187).
Chrome Alloy Steel, chrome plated.

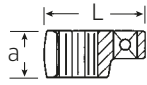
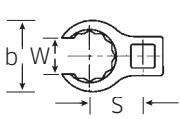

Code	mm	"	L mm	b mm	a mm	S mm	W mm	g	
01 19 00 08	8	1/4	23.8	12.7	8	12.3	6.3	11	1
01 19 00 09	9	1/4	28.5	18.2	13.5	14	6.7	21	1
01 19 00 10	10 ¹⁾	1/4	28.4	18.2	13.5	14	7.1	16	1
01 19 00 11	11	1/4	28	18.2	13.5	14	8.6	17	1
01 19 00 12	12 ¹⁾	1/4	30.8	20.6	14	15.7	9	20	1
01 19 00 13	13	1/4	32	22.2	14	16.4	10	20	1
01 19 00 14	14 ¹⁾	1/4	31.7	22.2	14	16.4	11.1	20	1
02 19 00 15	15	3/8	36.5	24.6	17.5	19.1	11.9	34	1
02 19 00 16	16	3/8	36.1	24.6	17.5	19.1	13	27	1
02 19 00 17	17 ²⁾	3/8	39.2	27.3	17.5	20.5	14	40	1
02 19 00 18	18	3/8	40.8	29	18.5	21.3	14.8	45	1
02 19 00 19	19 ²⁾	3/8	40.5	29	18.5	21.3	15.8	40	1
02 19 00 20	20	3/8	42.9	31.3	18.5	22.5	15.8	54	1
02 19 00 21	21	3/8	42.8	31.3	18.5	22.5	16.2	45	1
02 19 00 22	22 ²⁾	3/8	45.3	33.5	19	23.6	17	57	1
02 19 00 23	23	3/8	47.5	35.7	19.5	24.6	17.5	71	1
02 19 00 24	24 ²⁾	3/8	47.3	35.7	19.5	24.6	18	57	1
02 19 00 25	25	3/8	49.3	37.7	20	25.7	19	80	1
02 19 00 26	26	3/8	49.3	37.7	20	25.7	19	63	1
02 19 00 27	27	3/8	52.8	40	21.4	28.2	20	100	1
02 19 10 27	27MB ³⁾	3/8	57.1	42.1	15	29.3	20	92	1
03 19 00 28	28	1/2	56.8	42.1	22.5	29.3	21	120	1
03 19 00 30	30	1/2	63	48	22.5	32.5	22	155	1
03 19 00 32	32	1/2	62.5	48	22.5	32.5	24	137	1
03 19 00 34	34	1/2	64.2	50	24	33.5	27	148	1
03 19 00 36	36	1/2	66.5	51.9	24	34.6	27	150	1
03 19 00 38	38	1/2	68.1	53.9	24	35.6	28.6	147	1
03 19 00 40	40	1/2	71.8	57.9	24.5	37.7	31	160	1
03 19 00 41	41	1/2	71.8	57.9	24.5	37.7	31	169	1
03 19 00 42	42	1/2	71	57.9	24.5	37.7	33.2	189	1
03 19 00 46	46	1/2	77.7	64.2	26	40.9	34.1	215	1
03 19 00 50	50	1/2	83.2	70.5	27.5	44.1	39.7	295	1

¹⁾ For union nuts on fuel injection leads on 4-cylinder Mercedes-Benz diesel engines

²⁾ For use on suction or pressure lines within expansion valve of air conditioning unit (Mercedes-Benz)

³⁾ Slim-line version for setting of electronic injection on 440-HP-engines Mercedes-Benz series OM 442

440a

CROW-RING spanners

Code	"	"	L mm	b mm	a mm	S mm	W mm	g	
01 49 00 24	3/8 ¹⁾	1/4	28.4	18.2	13.5	14	7.1	14	1
01 49 00 28	7/16	1/4	28	18.2	13.5	14	8.6	14	1
01 49 00 32	1/2	1/4	30.5	20.6	14	15.7	10	19	1
01 49 00 34	9/16	1/4	31.7	22.2	14	16.4	11.1	23	1
02 49 00 36	5/8	3/8	36.5	24.6	17.5	19.1	11.9	33	1
02 49 00 38	11/16	3/8	39.2	27.3	17.5	20.5	14	36	1
02 49 00 40	3/4	3/8	40.9	29	18.5	21.3	14.2	44	1
02 49 00 42	13/16	3/8	42.9	31.3	18.5	22.5	15.8	51	1
02 49 00 44	7/8	3/8	45.2	33.5	19	23.6	17.5	62	1
02 49 00 46	15/16	3/8	47.2	35.7	19.5	24.6	18.3	63	1
02 49 00 48	1	3/8	49.3	37.7	20	25.7	19	71	1
02 49 00 50	1 1/16	3/8	52.8	40	21.4	28.2	20	84	1
03 49 00 52	1 1/8	1/2	56.8	42.1	22.5	29.3	21	110	1
03 49 00 56	1 1/4	1/2	62.5	48	22.5	32.5	23.8	137	1
03 49 00 58	1 5/16	1/2	62.3	48	22.5	32.5	24.6	130	1
03 49 00 60	1 3/8	1/2	64.2	50	24	33.5	27	138	1
03 49 00 62	1 7/16	1/2	66.5	51.9	24	34.6	27	143	1
03 49 00 64	1 1/2	1/2	68.1	53.9	24	35.6	28.6	152	1
03 49 00 65	1 9/16	1/2	70.1	55.9	24	36.7	29.4	172	1
03 49 00 66	1 5/8	1/2	71.8	57.9	24.5	37.7	31	169	1
03 49 00 68	1 3/4	1/2	75.6	62	25.5	39.8	33.2	199	1
03 49 00 69	1 13/16	1/2	77.7	64.2	26	40.9	34.1	229	1
03 49 00 72	2	1/2	83.2	70.5	27.5	44.1	39.7	277	1
03 49 00 76	2 1/4	1/2	91.2	78.7	29.5	48.2	42.8	337	1
03 49 00 77	2 5/16	1/2	93.3	80.9	30	49.2	43.6	309	1
03 49 00 78	2 3/8	1/2	95.2	83	30.5	50.2	46	385	1

¹⁾ For Volvo aero-engines, types "JAS"

440S MJ

CROW-RING spanners



Supersedes No 440 MJ

Caution! Modified settings on torque wrench (refer to note on page 187), EN 4108, for pipe unions with straight cylindrical involute toothing, HPQ® high performance steel, chrome plated.

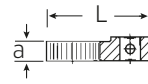
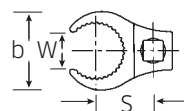

Code	Threaded nut	mm	"	L mm	b mm	a mm	S mm	W mm	g	
01 21 10 10	MJ10	DN04	1/4	31.9	22	8	17	6.5	25	1
01 21 10 14	MJ14	DN06	1/4	36.5	27	8	19.5	8.5	30	1
02 21 10 16	MJ16	DN08	3/8	43.8	31	8	24	10.5	50	1
02 21 10 18	MJ18	DN10	3/8	45.2	33	8	25	13	45	1
02 21 10 20	MJ20	DN12	3/8	46.2	35	8	26	15	50	1
02 21 10 22	MJ22	DN14	3/8	48.4	37	9	27	17.5	55	1
02 21 10 24	MJ24	DN16	3/8	49.5	39	9	28	19.7	60	1
02 21 10 27	MJ27	DN18	3/8	54.4	44	10	31	21.5	75	1
02 21 10 30	MJ30	DN20	3/8	60.8	50	10	36	23.7	95	1

540 CROW-FOOT spanners

Caution! Modified settings on torque wrench (refer to note on page 187), Chrome Alloy Steel, chrome plated.

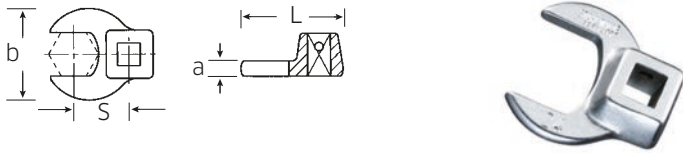

Code	mm	"	L mm	b mm	a mm	S mm	Δg	g	
01 20 00 08	8	1/4	25.5	19.8	6.3	14.6	21	1	
01 20 00 09	9	1/4	25.5	19.8	6.3	14.6	21	1	
01 20 00 10	10	1/4	25.5	19.8	6.3	14.6	20	1	
02 20 00 11	11	3/8	32	22.2	6.3	17.4	36	1	
02 20 00 12	12	3/8	34.3	25.4	6.3	18.2	37	1	
02 20 00 13	13	3/8	34.3	25.4	6.3	17.8	36	1	
02 20 00 14	14	3/8	37.7	30	6.3	20.8	46	1	
02 20 00 15	15	3/8	37.7	30	6.3	20.4	45	1	
02 20 00 16	16	3/8	37.7	30	6.3	19.9	45	1	
02 20 00 17	17	3/8	42.5	38	6.3	23.8	62	1	
02 20 00 18	18	3/8	42.5	38	6.3	22.9	61	1	
02 20 00 19	19	3/8	42.5	38	6.3	22.4	64	1	
02 20 00 20	20	3/8	42.4	38	6.3	25	55	1	
02 20 00 21	21	3/8	44.5	41	6.3	23.6	59	1	
02 20 00 22	22	3/8	44.5	41	6.3	24.2	64	1	
02 20 00 23	23	3/8	44.5	41	6.3	25.8	63	1	
02 20 00 24	24	3/8	44.4	41	6.3	26.2	60	1	
02 20 00 25	25	3/8	47	45	8	26.4	75	1	
02 20 00 26	26	3/8	47	45	8	27.6	80	1	
02 20 00 27	27	3/8	47	45	8	27.6	76	1	
02 20 00 28	28	3/8	50	50	8	29.3	78	1	
02 20 00 30	30	3/8	50	50	8	29.3	84	1	
02 20 00 32	32	3/8	53	57	8	30.5	95	1	
02 20 00 34	34	3/8	54.5	60	8	31.6	107	1	
02 20 00 36	36	3/8	56.5	62	8	32.8	100	1	
02 20 00 40	40	3/8	63	70	8	37.6	130	1	
02 20 00 41	41	3/8	63	70	8	37.2	130	1	
02 20 00 42	42	3/8	63	70	8	37.7	125	1	
02 20 00 46	46	3/8	72	82	8	43.1	191	1	
02 20 00 50	50	3/8	75	88	8	45.4	217	1	

540a CROW-FOOT spanners

Code	mm	"	L mm	b mm	a mm	S mm	Δg	g	
01 50 00 24	3/8	1/4	25.5	19.8	6.3	14.6	17	1	
02 50 00 28	7/16	3/8	32	22.2	6.3	17.2	34	1	
02 50 00 32	1/2	3/8	34.3	25.4	6.3	18.1	37	1	
02 50 00 34	9/16	3/8	37.7	30	6.3	20.9	40	1	
02 50 00 36	5/8	3/8	37.7	30	6.3	20.4	44	1	
02 50 00 38	11/16	3/8	42.5	38	6.3	24.1	62	1	
02 50 00 40	3/4	3/8	42.5	38	6.3	24	66	1	
02 50 00 42	13/16	3/8	42.3	38	6.3	24	59	1	
02 50 00 44	7/8	3/8	44.5	41	6.3	25.8	65	1	
02 50 00 48	1	3/8	47	45	8	26.7	78	1	
02 50 00 50	1 1/16	3/8	47	45	8	27.2	78	1	
02 50 00 52	1 1/8	3/8	50	50	8	28.5	84	1	
02 50 00 54	1 3/16	3/8	50	50	8	29.2	83	1	
02 50 00 56	1 1/4	3/8	53	57	8	30.3	101	1	
02 50 00 58	1 5/16	3/8	53	57	8	31.2	101	1	
02 50 00 60	1 3/8	3/8	54.5	60	8	32.3	105	1	
02 50 00 62	1 7/16	3/8	56.5	62	8	33.1	107	1	
02 50 00 64	1 1/2	3/8	58	65	8	34.5	118	1	
02 50 00 65	1 9/16	3/8	59.5	68	8	35.7	126	1	
02 50 00 66	1 5/8	3/8	63	70	8	37.3	140	1	
02 50 00 67	1 11/16	3/8	63	70	8	37.7	126	1	
02 50 00 68	1 3/4	3/8	68	76	8	40.4	161	1	
02 50 00 70	1 7/8	3/8	72	82	8	42	205	1	
02 50 00 72	2	3/8	75	88	8	44.8	214	1	
02 50 00 74	2 1/8	3/8	75.6	91	10	46	265	1	
02 50 00 76	2 1/4	3/8	80.5	96	10	49.5	297	1	
03 50 00 78	2 3/8	1/2	81.5	96	8	51.3	214	1	

447 Adaptor



Caution! Modified settings on torque wrench (refer to note on page 187), American sizes: SAE AS 954-E, HPQ® high performance steel, gunmetal finish.

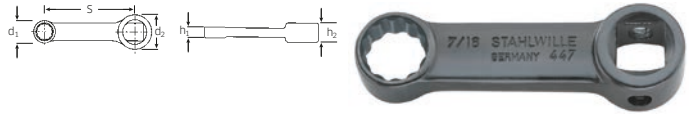

Code	mm	"	d1 mm	d2 mm	h1 mm	h2 mm	S mm	Δg	g
02 18 10 07	7	3/8	11.5	19	6	11	50.8	30	1
02 18 10 08	8	3/8	12.4	19	6	11	50.8	30	1
02 18 10 09	9	3/8	14	19	8	11	50.8	40	1
02 18 10 10	10	3/8	15.6	19	8	11	50.8	40	1
02 18 10 13	13	3/8	19.3	19	9.2	11	50.8	55	1

447a Adaptor

Code	mm	"	d1 mm	d2 mm	h1 mm	h2 mm	S mm	Δg	g
02 47 00 16	1/4	3/8	10.4	19	6	11	50.8	27	1
02 47 00 20	5/16	3/8	12.4	19	6	11	50.8	29	1
02 47 00 24	3/8	3/8	14.9	19	8	11	50.8	41	1
02 47 00 28	7/16	3/8	17	19	8	11	50.8	40	1
02 47 00 32	1/2	3/8	19	19	9.2	11	50.8	56	1
02 47 00 34	9/16	3/8	21	19	9.2	11	50.8	61	1
02 47 00 36	5/8	3/8	23	19	12	11	50.8	73	1

1225 Special extension

3/8" offset



Code	L mm	d mm	Δg	g
12 25 00 01	150	17	128	5

447aSP Spline-Drive adaptor



Caution! Modified settings on torque wrench (refer to note on page 187), MS-33787, MIL-W-8982, HPQ® high performance steel, gunmetal finish.

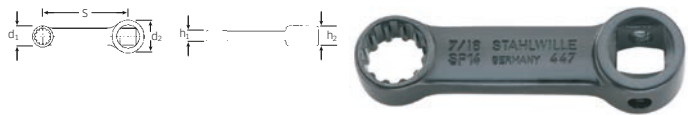

Code	Spline size	mm	"	d1 mm	d2 mm	h1 mm	h2 mm	S mm	Δg	g
02 48 00 14	7	7/32	3/8	9.4	19	6	11	50.8	27	1
02 48 00 16	8	1/4	3/8	10.4	19	6	11	50.8	27	1
02 48 00 18	9	9/32	3/8	11.5	19	6	11	50.8	29	1
02 48 00 20	10	5/16	3/8	12.4	19	6	11	50.8	29	1
02 48 00 24	12	3/8	3/8	14.9	19	8	11	50.8	40	1
02 48 00 28	14	7/16	3/8	17	19	9.2	11	50.8	50	1
02 48 00 32	16	1/2	3/8	19	19	9.2	11	50.8	59	1
02 48 00 34	18	9/16	3/8	21	19	9.2	11	50.8	55	1
02 48 00 36	20	5/8	3/8	23	19	12	11	50.8	74	1

MULTIPOWER

Makes child's play of the largest torques.

MULTIPOWER – or really “tough work”.

STAHLWILLE MULTIPOWER torque multipliers with planetary gears take the fatigue out of tightening or loosening stiff or large bolt connections. A long lever is not necessary.

STAHLWILLE MULTIPOWER multiplies human strength; steady torque transfer is easy on nuts and bolts. Even the largest torques are transferred with ease and precision over long periods.

Accordingly, construction materials and workmanship are extremely robust.

When combined with STAHLWILLE torque wrenches, MULTIPOWER really shows its strength.

The MULTIPOWER range extends to 5000 N·m/3687 ft·lb.

MULTIPOWER tools are also available on request up to 12000 N·m/8850 ft·lb.

The MULTIPOWER from 2000 N·m are fitted with an anti-backlash device.

Spare parts, see p. 220

MP300 MULTIPOWER

with overload protection and planetary gears, in carrying case, with one spare sun wheel (overload cut-out), deviation of indication ± 5%.



Code	size	N·m ¹⁾	ft·lb ¹⁾	N·m ²⁾	ft·lb ²⁾	Gear ratio	Torque ratio	□ "	■ "	b mm	h mm	L mm	Δ g	Δ g with box
53 03 0800	800	800	590	229	169	4 : 1	1 : 3.5	1/2	3/4	66	85	215	2000	5838
53 03 1350	1350	1350	996	375	277	4 : 1	1 : 3.6	3/4	3/4	90	106	265	3400	7500
53 03 2000	2000*)	2000	1475	160	118	16 : 1	1 : 12.5	1/2	1	95	161	330	7000	11000
53 03 3000	3000*)	3000	2212	240	177	16 : 1	1 : 12.5	3/4	1	95	161	330	7000	10805
53 03 5000	5000*)	5000	3687	294	217	20 : 1	1 : 17.0	3/4	1 1/2	120	180	400	10400	14000

MULTIPOWER tools are also available on request up to 12000 N·m/8850 ft·lb.

*) with anti-backlash device

1) max. output

2) max. input

MP100-1500 MULTIPOWER

- particularly compact construction
- light and easy to handle
- with ratchet function
- working angle 8°
- with rotary scale
- for use with a torque wrench with a fixed 1/2" square drive
- patents applied for
- in carry-case
- included in the set: 3 hexagon inserts sizes 30; 32; 36 mm,
1 insert with 1" outer square drive,
1 reaction arm 400 mm
- display deviation value ± 5%



Code	N·m ¹⁾	ft·lb ¹⁾	N·m ²⁾	ft·lb ²⁾	Gear ratio	Torque ratio	□ "	b mm	h mm	L mm	Δ g	Δ g with box
96 53 1500	1500	1106	300	221	5.62 : 1	1 : 5	1/2	105	30	165	1890	3630

1) max. output

2) max. input

Sets of spare parts for ratchet insert tools

4150QR Spare parts set



Content:
1 pinion; 1 pawl; 2 lever with pin; 1 ball; 2 compression springs; 2 screws
M 1.7 x 8; 2 cover plates

Code	for No	g	
1901 1020	725QR/4	24	1

4350QR Spare parts set



Content:
1 pinion, 1 pawl, 1 lever with pin, 1 ball, 2 compression springs, 2 screws

Code	for No	g	
1902 0020	725QR/5	51	1

7250QR/10 Spare parts set



Content:
1 pinion, 1 pawl, 1 lever with pin, 1 ball, 2 compression springs, 2 screws

Code	for No	g	
1904 1020	725QR/10	64	1

5120QR Spare parts set



Content:
1 pinion, 1 pawl, 1 lever with pin, 1 ball, 2 compression springs, 2 screws

Code	for No	g	
1904 0020	725QR/20	127	1

7250B Spare parts set

Content:
1 pinion, 1 pawl, 1 lever with pin, 1 ball, 2 compression springs, 2 screws,
1 cover plate

Code	size	for No	g	
1901 2022	4	725B/4	21	1
1901 2023	5	725B/5	48	1

7250L/5 Spare parts set

Content:
1 pinion, 1 pawl, 1 change-over button with pin, 1 ball, 2 compression
springs, 2 screws, 1 cover plate

Code	for No	g	
1902 1000	725L/5	70	1

7250/4 Spare parts set

Content:
1 pinion, 1 pawl, 1 lever with pin, 1 ball, 2 compression springs, 2 screws,
1 cover plate

Code	for No	g	
1901 2021	725/4	26	1

7350/5 Spare parts set

Content:
1 pinion, 1 pawl, 1 switching disk, 1 spring, 3 screws.

Code	for No	g	
5925 1005	735/5	85	1

for Knarren ab 12/97

7350/10 Spare parts set

Content:
1 pinion, 1 pawl, 1 switching disk, 1 spring, 3 screws.

Code	for No	g	
5925 1010	735/10	96	1

for ratchets from 12/97

7350/20 Spare parts set

Content:
1 pinion, 1 pawl, 1 switching disk, 1 spring, 3 screws.

Code	for No	g	
5925 1020	735/20	146	1

for ratchets from 4/96

7350/40 Spare parts set

Content:
1 pinion, 1 pawl, 1 switching disk, 1 spring, 3 screws.

Code	for No	g	
5925 1040	735/40	219	1

for ratchets from 5/97

7350/40HD-65 Spare parts set

Content:
1 pinion, 1 pawl, 1 switching disk, 1 spring, 3 screws.

Code	for No	g	
5925 1065	735/40HD, 735/65	300	1

Spare parts

7210 Ratchet spare parts sets for torque wrenches No 721

Code	No	Content	Δg g
59 19 1005	7210/5	For ratchet/torque wrench No 721/5, 721/5 Quick: 1 pinion, 1 pawl, 1 switch-over button and pin, 1 ball, 2 compression springs, 2 screws	53
19040000	5120 + 7210/15	For ratchet/torque wrench No 721/15, 721/15 Quick, 721/20, 721/20 Quick: 1 pinion, 1 pawl, 1 lever, 1 lever pin, 1 ball, 2 compression springs, 2 screws	127
59 19 1030	7210/30	For ratchet/torque wrench No 721/30, 721/30 Quick: 1 pinion, 1 pawl, 1 lever, 1 lever pin, 1 ball, 2 compression springs, 2 screws	134
59 19 1080	7210/80	For ratchet/torque wrench No 721Nf/80, 721Nf/100, 735/80, 735/100: 1 pinion, 2 pawls, 2 spring contact points, 2 compression springs	448

70V Square drive units

for torque wrenches and insert tools.

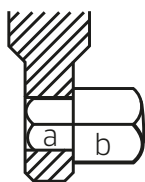

502^{1/2}



70V 16

Code	size	for No	a "	b "	L mm	Δg g	
59010001	1	71...V/1	1/4	1/4	17.5	5	5
59010014	11	734/4	3/8	1/4	22	12	5
59010003	3	734/5	3/8	3/8	25.8	17	5
59010005	5	734/10	3/8	1/2	30	28	5
59010011	502 1/2	720/30; 734/20	1/2	1/2	33.5	39	5
59010007	7	721/30	1/2	1/2	44.3	52	5
59010008	8	734/40	3/4	3/4	52.2	138	5
59010015	12	720Nf/80; 721Nf/80+100; 734/80; 734/100; 735/80; 735/100	3/4	3/4	65	179	1
59010016	16*	720Nf/80; 721Nf/80+100; 734/40; 734/80; 734/100; 735/80; 735/100	3/4	3/4	88	240	1

* extra-long, firmly locked, so usable from both sides

Spares for MULTIPOWER

SR290-393 Sun wheel with overload cutout

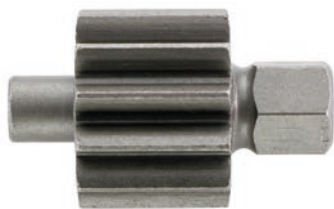

Code	No	for No	Δg g
59 03 08 00	SR300-800	MP300-800	45
59 03 13 50	SR300-1350	MP300-1350	106
59 03 20 00	SR300-2000	MP300-2000	120
59 03 30 00	SR300-3000	MP300-3000	130
59 03 50 00	SR300-5000	MP300-5000	127
59 30 00 39	SR290N	STW 290N	41
59 30 00 67	SR295N	STW 295N	95
59 30 00 68	SR391N	STW 391N	95
59 30 00 69	SR392N	STW 392N	105
59 30 00 70	SR393N	STW 393N	105



SmartCheck

Tester for torque wrenches and torque screwdrivers



Advantages at a glance

- Robust:** The integrated visual and audible overload protection mechanism ensures the durability customers expect of STAHLWILLE.
- Accurate:** The display deviation value of a mere $\pm 1\%$ guarantees the greatest possible measuring dependability. With certificate.
- Ready for work:** Thanks to the integrated transducer with a broad measuring range, work can start immediately.
- Flexible:** SmartCheck can be positioned almost anywhere. Whether horizontally or vertically - the well-thought-out fixing points, the compact construction and rotatable display make it easy to use.
- Versatile:** Three operating modes (track, first peak, peak hold) and three measuring units (N·m, ft·lb, in·lb) can be selected. The target torque and tolerances can be individually set to evaluate the readings.
- Mobile:** Ideal for use on the road if there are no power sockets available. Besides the usual operating mode using a mains adapter, this unit can be run on batteries (4 x AAA or 1 x 9 V block, adapter included).
- Rotatable:** SmartCheck can easily be adjusted to suit the user's angle of sight. Not only the display but also the display mount and base body can be rotated through 180° .
- Intuitive operation:** The unit is easy to use and has operator guidance to aid fast working, reliable results coupled with high levels of safety.
- Resilient:** The display and keypad are splash-proof, and the housing is made of impact-resistant plastic. Safe transport and storage is ensured by the sturdy transport box.
- For many torque ranges:** SmartCheck is available for these standard torque ranges: 1-10 N·m, 10-100 N·m, 40-400 N·m and 80-800 N·m.
- For starters:** STAHLWILLE will soon be expanding the torque tester family of products. The focus will always be on versatility, performance and ease of use. Smart? Checked!

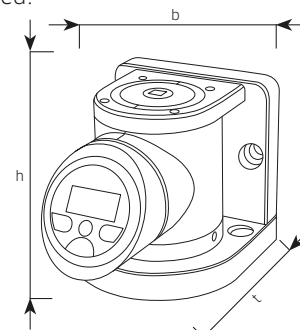

SmartCheck Electronic SmartCheck tester

NEW

Code	No	N·m	ft·lb	in·lb	Ø "	b mm	h mm	t mm	± g
96 52 12 01*	SmartCheck 10S	1-10	0.74-7.4	8.9-88.5	1/4	120	124	167	5210
96 52 12 02	SmartCheck 10	1-10	0.74-7.4	8.9-88.5	1/4	120	124	167	5210
96 52 12 03	SmartCheck 100	10-100	7-74	89-885	3/8	120	124	167	5310
96 52 12 04	SmartCheck 400	40-400	30-295	354-3540	3/4	120	124	167	5690
96 52 12 05	SmartCheck 800	80-800	59-590	708-7081	3/4	120	124	167	5690

* For testing torque screwdrivers

Torque testers

Electronic torque tester for torque wrenches **SENSOTORK® 7707 W** (For complete calibration systems, see p. 225, 229)

Compact torque tester for easy adaptation by replacement of the transducers.

High degree of accuracy thanks to flat transducer and conversion and digitalisation of readings within the transducer (see p. 223).

High degree of safety through display showing actual torque read-off where clicking torque wrenches are used.

7707 W Torque tester SENSOTORK®

Electronic torque tester for torque wrenches, consisting of:

- transducer, patent
- holder
- display unit (registered design)
- tripod for display unit (with 1.5 m cable)
- spiral cable
- mains adaptor (110 V-230 V with interchangeable socket adaptors) or direct connection to 12 V in-car supply is possible
- square drive adaptor (No 7707-2W, No 7707-2-1W, No 7707-2-2W, No 7707-3W)
- kit for attaching the unit to a workbench or wall in a horizontal or vertical testing position for clockwise and anticlockwise use. Units of measurement: N·m, ft·lb, in·lb.

The easily interchangeable transducers are attached to the holder by means of a QuickRelease safety lock. Low lateral forces thanks to low-profile transducers, automatic detection of the transducer, flexible and user friendly because the unit can be used horizontally or vertically and the display unit can be placed in many positions, additional tripod with 1.5 m cable for mounting the display unit to facilitate visual monitoring when using longer torque wrenches, especially broad measuring range from approx. 2% to 100% of rated value.

The software No 7759-4, including USB hub and jack cable (see p. 232), enables readings to be transferred to the PC for documenting (no separate power supply needed, power comes from PC). While individual transducers are being recalibrated, the torque tester itself remains on-site for further use. Wide range of application (-20°C to +60°C). Complies with DIN 51309: 2005, Class 2 and DKD-R 3-8: 2003. With certificate. Supplied in sturdy plastic case.

5

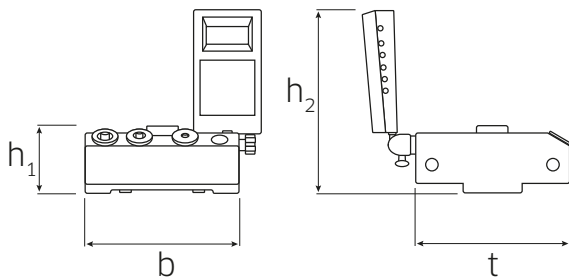

QuickRelease

Rapid change and firm locking of the transducers thanks to the QuickRelease safety lock.

Interchangeable square drive adapters:

A set of interchangeable square drive adapters are conveniently stored in the mounting block for a range of different drive sizes.



Code	No	Capacity N·m	Capacity ft·lb	Capacity in·lb	□ "	b mm	h ₁ mm	h ₂ mm	t mm	Δ _g g	Δ _g with box
96 52 10 86	7707-1-3W ¹⁾	0.2-10	0.15-7.4	1.8-88.5	1/4	180	79	215	180	6255	9500
96 52 10 85	7707-1-2W	0.2-10	0.15-7.4	1.8-88.5	1/4	180	79	215	180	6255	9500
96 52 10 80	7707-1W	0.4-20	0.3-15	3.5-177	1/4	180	79	215	180	6255	9500
96 52 10 72	7707-2W ²⁾	2-100	1.5-74	18-885	3/8	180	79	215	180	7025	10300
96 52 10 83	7707-2-1W ³⁾	4-200	3-148	35-1770	1/2	180	79	215	180	7511	10975
96 52 10 84	7707-2-2W ⁴⁾	8-400	6-295	71-3540	3/4	180	79	215	180	7654	11100
96 52 10 82	7707-3W ⁴⁾	25-1100	18-812	221-9736	3/4	180	79	215	180	7495	11000

¹⁾ for calibrating torque screwdrivers

²⁾ with square drive adaptor No 409M (1/4" □ x 3/8" ■)

³⁾ with square drive adaptors No 7789-4 (1/4" □ x 1/2" ■), No 7789-5 (3/8" □ x 1/2" ■)

⁴⁾ with square drive adaptors No 7787 (1/4" □ x 3/4" ■), No 7788 (3/8" □ x 3/4" ■), No 7789 (1/2" □ x 3/4" ■)

Which transducer is for which torque wrench?

(Declaration of Conformance to DIN EN ISO 6789-1, calibration certificates to DIN EN ISO 6789-2)

STAHLWILLE's recommendation:

+++ very well suited ++ well suited + suitable

Nr.	7721-1	7722	7723-1	7723-2	7723-3
730D/10		+++			
730D/20			+++		
730D/40				+++	
730D/65					+++
730N/2	+++				
730N/5		+++			
730N/10		+++	++		
730N/12			+++		
730N/20			+++	++	
730N/40				+++	
730N/65					+++
730Na/2	+++				
730Na/5		+++			
730Na/10		+++	++		
730Na/20			+++	++	
730Na/40				+++	
730/2	+++	++	+		
730/4		+++	++	+	
730a/2	+++	++	+		
730a/4		+++	++	+	
730/5		+++	++		
730/10		+++	++	+	
730/12			+++	+++	
730/20			+++	++	+
730/40				+++	++
730/65					+++

Nr.	7721-1	7722	7723-1	7723-2	7723-3	7724-1
730a/5		+++	++			
730a/10		+++	++	+		
730a/12			+++	++	+	
730a/20			+++	++	+	
730/80					+++	+
720Nf/80					+++	+
721/5		+++	++			
721/15			+++	++	+	
721/30				+++	++	
721Nf/80					+++	+
721Nf/100					+++	+
755R/1	+++					
755/4		+++	++			
755/10		+++	++	+		
755/20			+++	++	+	
755/30				+++	++	
71/40				+++	++	
71/80					+++	+
71aR/80					+++	+
73Nm/15	+++	++				
712R/6		+++				
712R/20			+++			
712R/40				+++		
713R/6		+++				
713R/20			+++			
713R/40				+++		

7721-7724 Transducers

QR
 Patent, for calibration of torque wrenches and torque screwdrivers, high degree of accuracy thanks to conversion and digitization of readings within the transducer itself. Not susceptible to lateral forces due to low-profile construction. Can also be used as part of a calibration system (see p. 225, 229). With certificate. Supplied in sturdy plastic case.



		Measuring ranges by deviation of indication												
Code	No	Display deviation value ± 1 % of the reading			Display deviation value ± 0.5 % of the reading			Display deviation value ± 0.25 % of the reading			∅ mm	∅ "	∆ g	∆ g with box
		N·m	ft·lb	in·lb	N·m	ft·lb	in·lb	N·m	ft·lb	in·lb				
96 52 10 21	7721¹⁾	0.2-10	0.15-7.4	1.8-88.5	1-10	0.74-7.4	8.9-88.5	2-10	1.5-7.4	17.7-88.5	120	1/4	1735	2411
96 52 10 00	7721-0	0.2-10	0.15-7.4	1.8-88.5	1-10	0.74-7.4	8.9-88.5	2-10	1.5-7.4	17.7-88.5	120	1/4	1735	2411
96 52 10 26	7721-1	0.4-20	0.3-15	3.5-177	2-20	1.5-15	18-177	4-20	3-15	35-177	120	1/4	1735	2411
96 52 10 22	7722	2-100	1.5-74	18-885	10-100	7-74	89-885	12-100	9-74	106-885	120	3/8	2486	3223
96 52 10 23	7723-1	4-200	3-148	35-1770	20-200	15-148	177-1770	40-200	30-148	354-1770	120	1/2	2983	3605
96 52 20 23	7723-2	8-400	6-295	71-3540	40-400	30-295	354-3540	80-400	59-295	708-3540	120	3/4	3134	3745
96 52 10 28	7723-3	25-1100	18-812	221-9736	110-1100	81-812	974-9736	220-1100	162-812	1947-9736	120	3/4	2998	3761
96 52 10 29	7724-1²⁾	150-3000	111-2214	1328-26553	300-3000	221-2214	2655-26553	600-3000	443-2214	5311-26553	195	1 1/2	10500	12000

¹⁾ for calibrating torque screwdrivers

²⁾ for use with mechanical loader No 7792 and 7792-1 (see p. 225)

Note!

Torque testers are measuring instruments! They have to be regularly calibrated and, where necessary, adjusted, using suitable calibration equipment. We recommend recalibrating every 12 months.



Accurate. Reliable. Safe.

STAHLWILLE calibration

Calibration - Calibration is the regular examination of the accuracy and reliability of torque tools. This is done using special-purpose calibrating equipment which is subject to stringent monitoring. This is essential because torque tools are precision instruments which are very often in use in safety-relevant environments. They are expected to provide the same level of accuracy in their readings reliably over long periods of time. In order to ensure these standards are guaranteed, it is essential that examination by means of calibration takes place at regular intervals and is documented.

At the very least, a calibration system must include the following components:

1

Mechanical loader - The mechanical loader is required for rapid, accurate fixing and operation of the torque wrench. The mechanical loader also ensures that the DIN EN ISO 6789 requirement for clicking torque wrenches is fulfilled, i.e. that, above 80% of the final torque value, the force can be applied slowly and steadily within the required time.



2

Transducer - The torque applied using the torque wrench is digitalised within the transducer and transmitted via USB cable to the PC, which ensures error-free transmission.



3

USB-Adaptor - From here, the data are transferred to the PC.



4

Cable - for connecting laboratory transducers No 7728 to USB adaptor, with jack plug and self-locking precision plug.



5

Square drive adaptor - The set includes the square drive adapters necessary to make full use of the measuring range of the transducers; e.g. for transducer No 7723-3 (internal square drive 3/4"), square drive adapter No 7787 (1/4" female to 3/4" male), No 7788 (3/8" female to 3/4" male) and No 7789 (1/2" female to 3/4" male).



6

Software - The data received in this way can then be used to issue a calibration certificate in accordance with DIN/ISO 6789.





Complete calibration systems with matched components



Mechanical base unit



Transducer laboratory



Cable
No 7751-1



USB adaptor No 7757-1



USB adaptor



PC/Printer - not included
in the delivery



Calibration systems No	7706-8 PC	7706-9 PC	7706-10 PC	7706-11 PC
Code	96 52 10 68	96 52 10 69	96 52 10 70	96 52 10 74
Weight/kg	14,2	67,6	70,6	108,4
Range/N-m	1-10	2-100	2-1000	20-3000
Mechanical loader	-	No 7791	No 7791	No 7792
Stand alone test attachment for torque screwdrivers	No 7790	-	-	-
Extension unit	-	-	No 7791-1	No 7792-1
Transducer laboratory	No 7728-1S (1-10 N-m)	No 7728-2 (2-20 N-m) No 7728-10 (10-100 N-m)	No 7728-2 (2-20 N-m) No 7728-10 (10-100 N-m) No 7728-40 (40-400 N-m) No 7728-100 (100-1000 N-m)	No 7728-20 (20-200 N-m) No 7728-100 (100-1000 N-m) No 7728-300 (300-3000 N-m)
USB adaptor	No 7757-1	No 7757-1	No 7757-1	No 7757-1
Jack cable	No 7751	No 7751	No 7751	No 7751
Cable for No 7728 (connection between transducer and USB adaptor)	No 7751-1	No 7751-1	No 7751-1	No 7751-1
Square drive adaptor	No 431 (3/8" \circ x 1/4" \blacksquare)	No 431 (3/8" \circ x 1/4" \blacksquare) No 409M (1/4" \circ x 3/8" \blacksquare)	No 7787 (1/4" \circ x 3/4" \blacksquare) No 7788 (3/8" \circ x 3/4" \blacksquare) No 7789 (1/2" \circ x 3/4" \blacksquare) No 409M (1/4" \circ x 3/8" \blacksquare)	No 7787 (1/4" \circ x 3/4" \blacksquare) No 7788 (3/8" \circ x 3/4" \blacksquare) No 7789 (1/2" \circ x 3/4" \blacksquare) No 7789-2 (3/4" \circ x 1 1/2" \blacksquare) No 7789-3 (1" \circ x 1 1/2" \blacksquare) No 7789-4 (1/4" \circ x 1/2" \blacksquare) No 7789-5 (3/8" \circ x 1/2" \blacksquare)
Calibrating square drive insert tools	-	No 734K/4 (1/4" \blacksquare) No 734K/5 (3/8" \blacksquare)	No 734K/4 (1/4" \blacksquare) No 734K/5 (3/8" \blacksquare) No 734K/20 (1/2" \blacksquare) No 734K/40 (3/4" \blacksquare)	No 734K/4 (1/4" \blacksquare) No 734K/5 (3/8" \blacksquare) No 734K/20 (1/2" \blacksquare) No 734K/40 (3/4" \blacksquare)
Adaptors	No 3115 (1/4" \blacksquare x 1/4" \bullet E 6,3) - No 3115/1 (1/4" \blacksquare x 1/4" \bullet C 6,3) -	-	-	-
Calibration software	TORKMASTER	TORKMASTER	TORKMASTER	TORKMASTER
DAkkS calibration certificates	1	2	4	3

Manu|tor|k®

Mechanical loaders for torque wrenches and torque screwdrivers

Thanks to the modular design, end users can put together their own mechanical loader according to their specific requirements. Extensions with additional components are possible any time. All the components are carefully matched to ensure compatibility and can be easily fitted. This slot-in system is easy to use and has a very accurate fit. The components can be quickly and easily locked together using the integrated screw joints. The display unit can be attached at various points of the system via a holder. In this way, every user can organise his or her work to suit themselves.

7791 Mechanical loaders up to 400 N·m

Measurement possible without moving the point of application of force.

Thanks to a specially designed force transmission system, mechanical loader No 7791 avoids the risk of the point of force application shifting during the calibration process. The lever below the test rail is actuated in a linear direction by the handwheel acting on a spindle. The linear motion is translated into a rotary movement which acts on the transducer. The torque wrench to be calibrated remains in the same position throughout the calibration process. This prevents measuring errors caused by the point of force application being moved. Thanks to a low-friction linear ball bearing, the torque wrench is automatically levelled as it is placed in the unit. A further linear ball bearing ensures the contact with the torque wrench is friction-free. The reduction in lateral forces acting on the transducer and in the friction on the point of contact with the torque wrench results in a corresponding reduction in mismeasurement. Patents applied for.

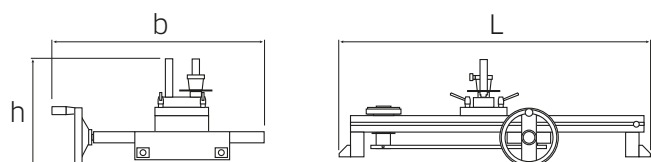

Code	Capacity N·m	for transducer	for torque wrenches with functional length (L_F) max. mm	Profile width mm	b mm	h mm	L mm	⊗ kg
52 11 0091	-400	sizes 1-100	815	180	704	323	1069	26.5

7791-1 Extension unit for No 7791, 7794-1 and 7794-2 up to 1000 N·m

with one pair of adapter plates No 7770-3 for height compensation between extension unit No 7791-1 and perfectControl calibrating units No 7794-1 and No 7794-2.

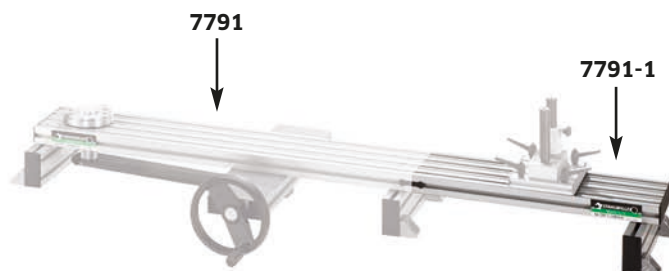
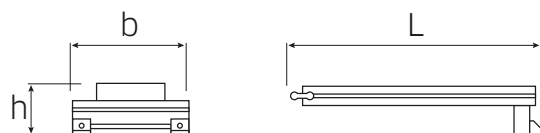

Code	Capacity N·m	for torque wrenches with functional length (L_F) max. mm	Profile width mm	b mm	h mm	L mm	⊗ kg
52 11 0191	-1000	1390 (7791 + 7791-1)	180	308	135	673	5.4

7792 Mechanical loaders unit to 1000 N-m

Patents applied for.



Code	Capacity N-m		for torque wrenches with functional length (L _F) max. mm	Profile width mm	b mm	h mm	L mm	Δ± kg
52 11 0092	-1000	size 20; 100; 300	1390	270	722	323	1668.5	57

7792-1 Extension unit for No 7792 up to 3000 N-m



Code	Capacity N-m		for torque wrenches with functional length (L _F) max. mm	Profile width mm	b mm	h mm	L mm	Δ± kg
52 11 0192	-3000		2390 (7792 + 7792-1)	270	558	135	1073	23.9

Test attachments for torque screwdrivers

7790 Mechanical loaders for torque screwdrivers

Can be bolted to mechanical loader No 7792. The torque screwdriver to be calibrated is inserted in the square mount of the transducer and fixed using the universal central clamp. The handwheel ensures that the required force is applied in a controlled manner to the torque screwdriver. Supplied without transducer or torque screwdriver.

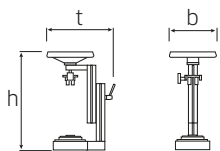

Code	Capacity N-m	for transducer	b mm	h mm	t mm	Δ± kg
58 52 1090	-10	7721; 7728-15	250	442-593	351	7.9

7791-2 Test attachment for torque screwdrivers

Can be bolted onto mechanical loader No 7791. The torque screwdriver to be calibrated is inserted in the square mount of the transducer and fixed using the universal central clamp. The handwheel ensures that the required force is applied in a controlled manner to the torque screwdriver.

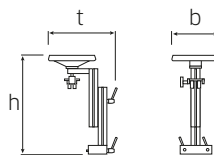

Code	Capacity N-m	b mm	h mm	t mm	Δ± kg
52 11 0291	-10	250	442-593	351	3.9

Accessory

7750-1 Holder

for display unit No 7750.
Can be bolted to test attachments.



Code	Δ± g
52 10 1050	165



Audited. Documented. Certified. STAHLWILLE DAkkS calibration laboratory

You can ensure controlled tightening, record the results of tightening processes, monitor torque tools.

STAHLWILLE's DAkkS calibration laboratory for torque is accredited by the German Accreditation Body (DAkkS) in accordance with DIN EN ISO/IEC 17025: 2005. Which means the specific requirements listed in Technical Specification ISO/TS 16949 relating to testing laboratories are met. Absolutely essential: This is absolutely essential to all suppliers in the automotive sector!

The transfer torque wrenches and torque transducers in use at STAHLWILLE's DAkkS calibration laboratory are subject to regular examination by the German Federal Physics Institute (PTB) in Braunschweig. The accuracy of the torque wrenches must be proved in a series of steps and these must be traceable. Only in this way can the reliability of the readings be guaranteed. During the first stage, the end-user checks the accuracy of the torque tools in-house using suitable calibrated testing equipment. At the next stage, this test equipment is checked in STAHLWILLE's DAkkS calibrating laboratory. This accreditation by the German Accreditation Body (DAkkS) in accordance with DIN EN ISO/IEC 17025: 2005 guarantees the direct link between the measuring equipment and the national standard as laid down in DIN EN ISO 9001: 2008.

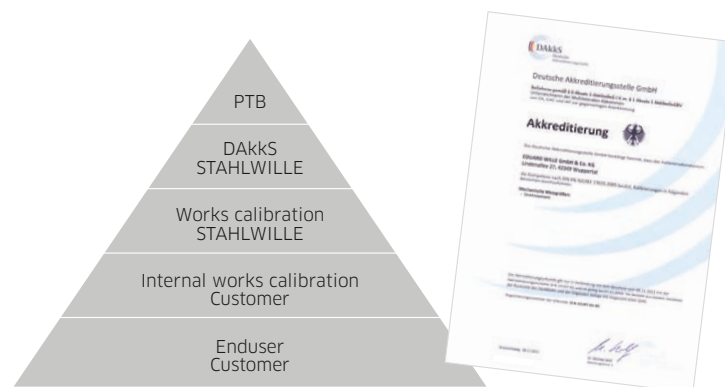

Relationship between the national standard and the equipment





Complete calibration systems perfectControl with matched components



**Motorised calibrating tool
No 7794-2**



Transducer laboratory



USB adaptor No 7757-1



**PC/Printer - not included
in the delivery**



**Manual calibrating unit
No 7794-1**



Calibration systems No	7794-2/400	7794-2/1000	7794-1/400	7794-1/1000
Code	96 52 10 78	96 52 10 79	96 52 10 76	96 52 10 77
Weight/kg	62,1	69,8	53,2	60,9
Range/N·m	1-400	1-1000	1-400	1-1000
Motorised calibrating unit	No 7794-2	No 7794-2	-	-
Manual calibrating unit	-	-	No 7794-1	No 7794-1
Extension unit	-	No 7791-1	-	No 7791-1
Transducer laboratory	No 7728-1 (1-10 N·m) No 7728-6 (6-60 N·m) No 7728-40 (40-400 N·m)	No 7728-1 (1-10 N·m) No 7728-6 (6-60 N·m) No 7728-40 (40-400 N·m) No 7728-100 (100-1000 N·m)	No 7728-1 (1-10 N·m) No 7728-6 (6-60 N·m) No 7728-40 (40-400 N·m)	No 7728-1 (1-10 N·m) No 7728-6 (6-60 N·m) No 7728-40 (40-400 N·m) No 7728-100 (100-1000 N·m)
USB Adaptor	No 7757-1	No 7757-1	No 7757-1	No 7757-1
Jack cable	No 7751	No 7751	No 7751	No 7751
Spiral cable	No 7752	No 7752	No 7752	No 7752
Cable for No 7728	No 7751-2	No 7751-2	No 7751-2	No 7751-2
Square drive adaptor	No 409M (1/4" ○ x 3/8" ■) No 7787 (1/4" ○ x 3/4" ■) No 7788 (3/8" ○ x 3/4" ■) No 7789 (1/2" ○ x 3/4" ■) No 7789-4 (1/4" ○ x 1/2" ■) No 7789-5 (3/8" ○ x 1/2" ■)	No 409M (1/4" ○ x 3/8" ■) No 7787 (1/4" ○ x 3/4" ■) No 7788 (3/8" ○ x 3/4" ■) No 7789 (1/2" ○ x 3/4" ■) No 7789-4 (1/4" ○ x 1/2" ■) No 7789-5 (3/8" ○ x 1/2" ■)	No 409M (1/4" ○ x 3/8" ■) No 7787 (1/4" ○ x 3/4" ■) No 7788 (3/8" ○ x 3/4" ■) No 7789 (1/2" ○ x 3/4" ■) No 7789-4 (1/4" ○ x 1/2" ■) No 7789-5 (3/8" ○ x 1/2" ■)	No 409M (1/4" ○ x 3/8" ■) No 7787 (1/4" ○ x 3/4" ■) No 7788 (3/8" ○ x 3/4" ■) No 7789 (1/2" ○ x 3/4" ■) No 7789-4 (1/4" ○ x 1/2" ■) No 7789-5 (3/8" ○ x 1/2" ■)
Calibrating square drive insert tools	No 734K/4 (1/4" ■) No 734K/5 (3/8" ■) No 734K/12 (3/8" ■) No 734K/20 (1/2" ■) No 734K/40 (3/4" ■) No 734K/100 (3/4" ■)	No 734K/4 (1/4" ■) No 734K/5 (3/8" ■) No 734K/12 (3/8" ■) No 734K/20 (1/2" ■) No 734K/40 (3/4" ■) No 734K/100 (3/4" ■)	No 734K/4 (1/4" ■) No 734K/5 (3/8" ■) No 734K/12 (3/8" ■) No 734K/20 (1/2" ■) No 734K/40 (3/4" ■) No 734K/100 (3/4" ■)	No 734K/4 (1/4" ■) No 734K/5 (3/8" ■) No 734K/12 (3/8" ■) No 734K/20 (1/2" ■) No 734K/40 (3/4" ■) No 734K/100 (3/4" ■)
Calibration software	TORKMASTER	TORKMASTER	TORKMASTER	TORKMASTER
DAkKS calibration certificates	3	4	3	4

perfectControl®

7794-2 Motorised calibrating and adjusting tool from 1 to 400 N-m

The electronic perfectControl calibrating unit with its electric drive considerably reduces the amount of effort and time required for calibration and adjustment tasks on torque wrenches.



product
design
award

2011

- measurement possible without moving the point of application of force.
- prevents faulty readings thanks to precision-mounted spindle and finely regulated motor.
- extremely accurate calibration thanks to optimised bearings and square drives for the transducers.
- rapid, easy change of transducers thanks to quick-release latching system.
- convenient pushbutton controls for clockwise and anticlockwise measurements with automatic speed compensation.
- saves time because the bridge support is locked in place using a single-handed eccentric lever.
- transmission of readings to a PC via USB interface for further processing, analysis and archiving.
- calibration certificates can be printed or saved as a PDF file after calibration.
- as found / as left calibrations can be documented.
- during calibration, DIN EN ISO 6789 in numerous languages is supported. Additional standards and works standards are available on request.
- can be upgraded to perfectControl calibrating unit No 7794-3 for angle-controlled wrenches.
- **calibration up to 1000 N-m is possible using the easily attached extension unit No 7791-1** (see p. 226).
- design patent, other patents applied for

Both clicking and indicating torque wrenches can be calibrated. Calibration of transducers is possible using reference torque wrenches No 7770-100 and 7770-1000, available on request.

6 calibrating square drive insert tools No 734K (sizes 4, 5, 12, 20, 40, 100), 6 square drive adaptors (No 409M, No 7787, No 7788, No 7789, No 7789-4, No 7789-5), 1 USB adaptor No 7757-1, 1 software Torkmaster 7731-1, 1 jack cable No 7751, 1 spiral cable No 7752, 1 spiral cable No 7751-2 with jack plug and self-locking precision plug, 1 low-temperature cable connector, 1 hexagon key wrench No 10760CV size 2 mm are included.

The unit is supplied without the torque wrench, transducers or notebook.

Transducers laboratory No 7728 (see p. 231).

5



7794-2

Code	Capacity N-m	for transducer	for torque wrenches with functional length (L _F) max. mm	Profile width mm	b mm	h mm	L mm	⊕ kg
96 52 1093	1-400	7728 (size 1-100)	815	180	640	328	1060	57

7794-1 Manual calibrating unit from 1 to 400 N-m

As for perfectControl No 7794-2, but the drive is via an ergonomically designed handwheel.

Calibration up to 1000 N-m is possible using the easily attached extension unit No 7791-1 (see p. 228). Patents applied for. 6 calibrating square drive insert tools No 734K (sizes 4, 5, 12, 20, 40, 100), 6 square drive adaptors (No 409M, No 7787, No 7788, No 7789, No 7789-4, No 7789-5), 1 USB adaptor No 7757-1, 1 software Torkmaster 7731-1, 1 jack cable No 7751, 1 spiral cable No 7752, 1 spiral cable No 7751-2 with jack plug and self-locking precision plug, 1 low-temperature cable connector, 1 hexagon key wrench No 10760CV size 2 mm are included.

Supplied without torque wrench, transducer or notebook.

Transducers laboratory No 7728 (see p. 231).



7794-1

Code	Capacity N-m	for transducer	for torque wrenches with functional length (L _F) max. mm	Profile width mm	b mm	h mm	L mm	⊕ kg
96 52 1092	1-400	7728 (size 1-100)	815	180	705	355	1060	47

7794-3 Automated calibrating and adjusting unit from 1 to 400 N·m

Automatically calibrates electronic torque and angle-controlled wrenches made by STAHLWILLE

Design patent, other patents applied for.

Model is the same as perfectControl No 7794-2, except it is additionally suited to calibrating angle-controlled wrenches.

Optimum adaptation to working height with motorised height adjustment.

6 calibrating square drive insert tools No 734K (sizes 4, 5, 12, 20, 40, 100), 6 square drive adaptors (No 409M, No 7787, No 7788, No 7789, No 7789-4, No 7789-5), 1 USB adaptor No 7757-1, 1 software Torkmaster 7731-1, 1 jack cable No 7751, 1 spiral cable No 7752, 1 spiral cable No 7751-2 with jack plug and self-locking precision plug, 1 low-temperature cable connector, 1 hexagon key wrench No 10760CV size 2 mm are included. Calibration up to 1000 N·m is possible using the easily attached expansion unit No 7791-1 (see p. 226) and set of adapter plates No 7791-4, Code 52110491.

Supplied without torque wrench, transducer or notebook.



Code	Capacity N·m	for transducer	for torque wrenches with functional length (L _F) max. mm	Profile width mm	b mm	h mm	L mm	Δ∅ kg
96 52 1094	1-400	7728 (sizes 1-100)	815	180	640	884-1134	1060	230

7728 Transducers laboratory



patented, for laboratory environments, with optimised measuring range, for calibrating torque wrenches and torque screwdrivers, for use together with perfectControl calibrating unit No 7794 or calibration system No 7706.

High degree of accuracy thanks to conversion and digitization of readings within the transducer itself. With high-grade self-locking precision plug. Not susceptible to lateral forces due to low-profile construction.

With DAKKS calibration certificate. Max. display deviation value ± 0.5% of the reading.

Further details on request. Supplied in sturdy plastic case.



		Measuring ranges by deviation of indication									
Code	size	Display deviation value ± 0.5 % of the reading			Display deviation value ± 0.25 % of the reading			∅ mm	∅"	Δ∅ g	Δ∅ g with box
		N·m	ft·lb	in·lb	N·m	ft·lb	in·lb				
96 52 40 11	15 ¹⁾	1-10	0.74-7.4	8.9-88.5	2-10	1.5-7.4	18-88.5	120	1/4	1735	2415
96 52 40 01	1	1-10	0.74-7.4	8.9-88.5	2-10	1.5-7.4	18-88.5	120	1/4	1735	2415
96 52 40 02	2	2-20	1.5-15	18-177	4-20	3-15	35-177	120	1/4	1735	2415
96 52 40 04	4	4-40	3-30	35-354	8-40	6-30	71-354	120	3/8	2486	3136
96 52 40 06	6	6-60	4.5-45	53-531	12-60	9-45	106-531	120	3/8	2486	3136
96 52 40 10	10	10-100	7-74	89-885	20-100	14-74	177-885	120	3/8	2486	3136
96 52 40 20	20	20-200	15-148	177-1770	40-200	30-148	354-1770	120	1/2	2983	3170
96 52 40 40	40	40-400	30-295	354-3540	80-400	60-295	708-3540	156	3/4	4846	5507
96 52 40 65	65	65-650	48-479	575-5753	130-650	96-479	1151-5753	156	3/4	4846	5507
96 52 40 80	80	80-800	59-590	708-7081	160-800	118-590	1416-7081	156	3/4	4846	5507
96 52 41 00	100	100-1000	74-738	885-8851	200-1000	148-738	1770-8851	156	3/4	4846	5507
96 52 43 00	300 ²⁾	300-3000	221-2214	2655-26553	600-3000	443-2214	5310-26553	195	1 1/2	10500	12000

¹⁾ for calibrating torque screwdrivers

²⁾ for use with mechanical loader No 7792 and 7792-1 (see p. 227)

Accessories for workshop torque tester and calibration systems

7750 Display unit

registered design, for displaying the actual torque as measured.

Units of measurement: N·m, ft·lb, in·lb.

Modes of operation: track, peak hold, first peak (only with manual operation), additional display of actual torque applied with clicking torque wrenches. Swivels to any desired position thanks to universal ball-joint.



Code	L m	Δ∇ g
52 10 00 50	1.5	182

7759-4 USB adaptor, jack cable and software Torkmaster

Link between perfectControl or transducer and PC. For adjusting and calibrating torque wrenches and torque screwdrivers.

Produces calibration certificates in accordance with DIN EN ISO 6789, which can be printed out or saved as PDF files.

- as found / as left calibrations can be documented.
- graphical representation of the torque progression
- user management
- 17 languages
- equipment testing system

System requirements:

- PC
- Microsoft Windows XP SP3 or later operating system
- USB connection

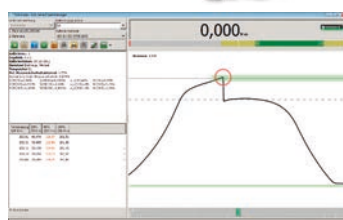

Code	L m	Δ∇ g
96 58 36 29	1.5	137

7751 Jack cable

Connection between transducers 7721-7724 and USB adaptor or display unit, with jacks at both ends, 90° angled.



Code	L m	Δ∇ g
52 11 00 51	1.5	50

7752 Spiral cable

Connection between transducer and display unit or USB adaptor, with jacks at both ends, 90° angled.



Code	L M mm	Δ∇ g
52 11 00 52	500	35

7751-1 Cable for No 7728

for connecting laboratory transducers 7728 to a USB hub or display unit, with jack plug, 90° angled, and self-locking precision plug..



Code	L m	Δ∇ g
52 11 00 54	1.5	50

7751-2 Spiral cable for No 7728

for connecting laboratory transducers 7728 to a USB hub or display unit, with jack plug, 90° angled, and self-locking precision plug.



Code	L M mm	Δ∇ g
52 11 00 57	500	50

7760 Mains adaptor

Input: 110 V-230 V AC ,
Output: 9 V DC,
with interchangeable socket adaptors.



Code	Volt	Δ∇ g
52 11 00 56	110-230	385

7761 Interface adaptor

Input: 110 V-230 V AC ,
Output: 9 V DC,
with interchangeable socket adaptors.



Code	Δ∇ g
52 11 00 61	26

7761/3 Interface adaptor set

Contents
No 7761 interface adaptor
No 7752 spiral cable
No 7760 mains adaptor



Code	Δ∇ g
96 52 11 61	446

7311/7312 Plastic case, empty

for safe storage and transport of transducers (please order inlays separately).



Code	No	for transducer	Δ g
81 50 0003	7311	7721; 7722; 7723; 7728 1-20	554
81 50 0004	7312	7724-1; 7728 40-100	1346

7313/7314 Inlays for plastic case

Code	No	for transducer	Δ g
83 07 1030	7313	7721; 7722; 7723; 7728 1-20	77
83 07 1031	7314	7724-1; 7728 40-100	242

409M Mains adaptor

1/4" socket x 3/8" plug (6.3 x 10).

Code	L mm	ϕ mm	Δ g
11 03 00 10	13	28	14



7787 Square drive adaptor

1/4" socket x 3/4" plug (6.3 x 20).

Code	L mm	ϕ mm	Δ g
58 52 1087	15.5	29	41



7788 Square drive adaptor

3/8" socket x 3/4" plug (10 x 20).

Code	L mm	ϕ mm	Δ g
58 52 1088	23.5	29	52



7789 Square drive adaptor

1/2" socket x 3/4" plug (12.5 x 20).

Code	L mm	ϕ mm	Δ g
58 52 1089	23.5	29	42



7789-2 Square drive adaptor

3/4" socket x 1 1/2" plug (20 x 40).

Code	L mm	ϕ mm	Δ g
58 52 3089	44	60	383



7789-3 Square drive adaptor

1" socket x 1 1/2" plug (25 x 40).

Code	L mm	ϕ mm	Δ g
58 52 4089	44	60	291

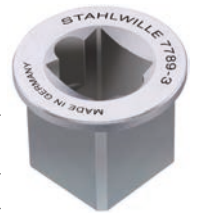

7789-4 Square drive adaptor

1/4" socket x 1/2" plug (6.3 x 12.5).

Code	L mm	ϕ mm	Δ g
58 52 4090	15.5	29	25



7789-5 Square drive adaptor

3/8" socket x 1/2" plug (10 x 12.5).

Code	L mm	ϕ mm	Δ g
58 52 4091	15.5	29	28

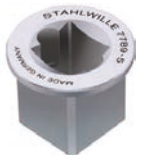

734K Calibrating square drive insert tools

Without a ball or pin (so not suitable for bolt tightening). Optimum measuring results during calibration thanks to reduced lateral forces.

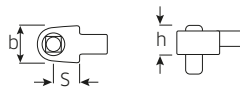

Code	size	"	mm	b mm	h mm	S mm	Δ g
58 24 3004	4	1/4	9x12	20	17.2	17.5	76
58 24 3005	5	3/8	9x12	20	16.7	17.5	80
58 24 3012	12	3/8	14x18	27	21.5	25	199
58 24 3020	20	1/2	14x18	27	21.5	25	218
58 24 3040	40	3/4	14x18	40	29.3	25	410
58 24 1100	100	3/4	22x28	43	29.3	55	895

70VK Calibrating square drive insert tools

Without a ball or pin (so not suitable for bolt tightening). Optimum measuring results during calibration thanks to reduced lateral forces.

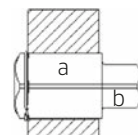

Code	size	for No	a "	b "	L mm	Δ g	
5901 1014	11	734/4	3/8	1/4	24.7	15	5
5901 1003	3	734/5	3/8	3/8	27.6	20	5
5901 1012	12	734/10, 734/20	1/2	3/8	32.5	34	5
5901 1011	502 1/2	734/20	1/2	1/2	36.9	60	5
5901 1008	8	734/40, 734/80, 734/100	3/4	3/4	52.2	147	5



6 | SCREWDRIVERS

DRALL⁺

→ PAGE 236



3K DRALL[®]

→ PAGE 242



ELECTRONICS SCREWDRIVERS

→ PAGE 244



T-HANDLED SCREWDRIVERS

→ PAGE 245



OFFSET SCREWDRIVERS

→ PAGE 247



OTHER

→ PAGE 249





Great freedom of choice – DRALL+ screwdrivers



A new challenge every day, a new tool every day to meet that challenge. The **DRALL+** series was developed for professionals faced with new challenges on a daily basis. Development focussed on three crucial user requirements: durability and reliability, safety in use, pleasant to handle. These requirements are met in full by **DRALL+** screwdrivers – in fact, they feel so natural, you will hardly notice them.

The profiles

DRALL+ is available for the following screwhead profiles:

- ⊖ Slotted
- ⊕ PH cross-head
- ⊕ PZ cross-head
- ⊗ TORX®
- ⊗ TORX® Tamper Resistant with a central bore
- ⦿ Hex
- ⊕ TORQ-SET®



4 handle sizes

The handle sizes for the **DRALL+** screwdrivers are designed specifically to match the drive profiles.



6



1

The hand-stop helps to stop injuries – Flange-like design. Supports your hand in the direction of the blade to prevent it slipping off the handle. Features integrated anti-roll shape.

2

The multifunctional section – The lower end of the handle is deliberately made extra-long. This enables the thumb and index finger to wrap around more easily and spin the screwdriver.

3

The transmission zone – The rounded cross-section in the central area combines maximum grip and easy turning.

4

The elastic handle components – The soft rubber textured thermoplastic elastomer (TPE) fits snugly in the hand. These sections are injection moulded around the hard core and bonded to it inseparably.

5

The firm handle components – The green zones are made of high-grade, impact-safe polypropylene (PP). The tang is anchored in the core to allow force to be transferred through it.

6

Head marking – convenient marking on the head makes it easier to pick the right profile.

7

Impact-resistant cap – For use under extreme conditions, the **DRALL+** is also available with a metal impact cap.

4620 Screwdrivers for slotted screws DRALL⁺

DIN ISO 2380-1, -2, DIN 5264, ISO 2380-1, -2, Chrome Alloy Steel, chrome plated, black tips.



Code	size	a mm	b mm	L ₁ mm	L ₂ mm	△△ g	
46 20 30 35	1	0.6	3.5	75	160	37	10
46 20 30 40	2	0.8	4.0	100	185	40	10
46 20 30 55	3	1.0	5.5	125	240	79	10
46 20 30 65	4	1.2	6.5	150	265	100	10
46 20 30 80	5	1.6	8.0	175	300	136	10
46 20 31 00	6	1.6	10.0	200	325	163	5
46 20 31 20	7	2.0	12.0	250	375	215	5

4621 Screwdrivers for slotted screws DRALL⁺

parallel blades, as per VSM (Swiss Standard), Chrome Alloy Steel, chrome plated, black tips.



Code	size	a mm	b mm	L ₁ mm	L ₂ mm	△△ g	
46 21 30 25	0	0.4	2.5	80	165	36	10
46 21 30 35	1	0.5	3.5	90	175	40	10
46 21 30 40	2	0.6	4.0	100	185	42	10
46 21 30 55	3	0.8	5.5	120	235	78	10
46 21 30 65	4	1.0	6.5	140	255	96	10
46 21 30 80	5	1.2	8.0	160	275	117	10
46 21 31 00	6	1.6	10.0	180	305	160	10

4622 Screwdrivers for slotted screws DRALL⁺

DIN ISO 2380-1, -2, DIN 5264, ISO 2380-1, -2, with hexagon, Chrome Alloy Steel, chrome plated, black tips.



Code	size	a mm	b mm	L ₁ mm	L ₂ mm	△△ g	
46 22 30 55	1	1.0	5.5	100	215	85	10
46 22 30 65	2	1.2	6.5	125	240	100	10
46 22 30 80	3	1.2	8.0	150	275	159	10
46 22 31 00	4	1.6	10.0	175	300	174	10
46 22 31 20	5	2.0	12.0	200	325	240	5
46 22 31 40	6	2.5	14.0	250	375	310	5

4622SK Screwdrivers for slotted screws DRALL⁺

DIN ISO 2380-1, -2, DIN 5264, ISO 2380-1, -2, with impact cap and hexagonal shank, Chrome Alloy Steel, chrome plated, black tips.



Code	size	a mm	b mm	L ₁ mm	L ₂ mm	△△ g	
46 22 32 40	1	0.8	4.0	90	195	50	10
46 22 32 55	2	1.0	5.5	100	215	106	10
46 22 32 65	3	1.2	6.5	125	240	135	5
46 22 32 80	4	1.2	8.0	150	275	191	5
46 22 32 00	5	1.6	10.0	175	300	226	5
46 22 32 20	6	2.0	12.0	200	325	267	5
46 22 33 40	7	2.5	14.0	250	375	340	5

4724 Carburettor screwdrivers DRALL

DIN ISO 2380-1, -2, DIN 5264, ISO 2380-1, -2, stubby, Chrome Alloy Steel, chrome plated, black tips.



Code	size	a mm	b mm	L ₁ mm	L ₂ mm	△△ g	
47 24 10 45	1	0.6	3.5	25	80	34	10
47 24 10 60	2	1.0	5.5	25	80	32	10
47 24 10 80	3	1.2	8.0	25	80	39	10

4628 Electricians screwdrivers for slotted screws DRALL⁺

DIN ISO 2380-1, -2, DIN 5264, ISO 2380-1, -2, Chrome Alloy Steel, chrome plated, black tips.



Code	size	a mm	b mm	L ₁ mm	L ₂ mm	△△ g	
46 28 30 25	1	0.4	2.5	60	145	20	10
46 28 30 35	2	0.6	3.5	75	160	40	10
46 28 31 35	3	0.6	3.5	100	185	41	10
46 28 30 40	4	0.8	4.0	125	210	46	10
46 28 30 55	5	1.0	5.5	150	265	92	10
46 28 31 55	6	1.0	5.5	200	315	102	10

4630 Cross-head screwdrivers DRALL⁺

Phillips-Recess®, DIN ISO 8764-1, -2, ISO 8764-1, -2, Chrome Alloy Steel, chrome plated, black tips.



Code	PH size	L ₁ mm	L ₂ mm	△△ g	
46 30 30 00	0	60	145	35	10
46 30 30 01	1	80	185	44	10
46 30 30 02	2	100	215	90	10
46 30 30 03	3	150	275	146	10

4631 Cross-head screwdrivers DRALL⁺

Phillips-Recess®, extra long, DIN ISO 8764-1, -2, ISO 8764-1, -2, Chrome Alloy Steel, chrome plated, black tips.



Code	PH size	L ₁ mm	L ₂ mm	△△ g	
46 31 30 01	1	250	355	110	1
46 31 30 02	2	250	365	122	1

4632 Cross-head screwdrivers DRALL⁺

with hexagon, Phillips-Recess®, DIN ISO 8764-1, -2, ISO 8764-1, -2, Chrome Alloy Steel, chrome plated, black tips.





Code	PH size	L ₁ mm	L ₂ mm	△△ g	
46 32 30 01	1	80	185	45	10
46 32 30 02	2	100	215	100	10
46 32 30 03	3	150	275	170	5
46 32 30 04	4	200	325	237	5

Screwdrivers

4632SK Cross-head screwdrivers DRALL⁺

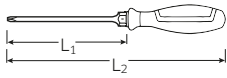
with impact cap and hexagonal shank, Phillips-Recess®, DIN ISO 8764-1, -2, ISO 8764-1, -2, Chrome Alloy Steel, chrome plated, black tips.



Code	PH size	L ₁ mm	L ₂ mm	△△ g	
46 32 31 01	1	85	190	58	10
46 32 31 02	2	100	215	130	10
46 32 31 03	3	150	275	194	5

4640 Cross-head screwdrivers DRALL⁺

POZIDRIV/SUPADRIV®, DIN ISO 8764-1, -2, ISO 8764-1, -2, Chrome Alloy Steel, chrome plated, black tips.

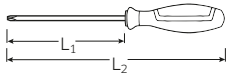



Code	PZ size	L ₁ mm	L ₂ mm	△△ g	
46 40 30 00	0	60	145	35	10
46 40 30 01	1	80	185	44	10
46 40 30 02	2	100	215	89	10
46 40 30 03	3	150	275	145	5

4636 TORQ-SET® screwdrivers DRALL⁺

TORQ-SET®, hexagonal blade, chrome plated, black tips.



Code	No	L ₁ mm	L ₂ mm	Außen " 	△△ g	
46 36 30 02	2	100	215	1/4	92	5
46 36 30 04	4	100	215	1/4	93	5
46 36 30 06	6	100	215	1/4	92	5
46 36 30 08	8	100	215	1/4	93	5
46 36 30 10	10	100	215	1/4	93	5
46 36 30 16	1/4	150	265	5/16	138	5

4650 TORX® screwdrivers DRALL⁺

for inside TORX® screws, Chrome Alloy Steel, chrome plated, black tips.



Code	size	mm	L ₁ mm	L ₂ mm	△△ g	
46 50 30 05	T5	1.4	60	145	30	5
46 50 30 06	T6	1.6	60	145	35	5
46 50 30 07	T7	2.0	60	145	35	5
46 50 30 08	T8	2.3	60	145	33	5
46 50 30 09	T9	2.5	60	145	35	5
46 50 30 10	T10	2.7	80	165	40	5
46 50 30 15	T15	3.3	80	165	38	5
46 50 30 20	T20	3.8	100	205	46	5
46 50 30 25	T25	4.4	100	205	50	5
46 50 30 27	T27	5.0	115	230	90	5
46 50 30 30	T30	5.5	115	230	90	5
46 50 30 40	T40	6.6	115	240	131	5
46 50 30 45	T45	7.8	130	255	136	5

4650L TORX® screwdrivers DRALL⁺

for inside TORX® screws, extra long, Chrome Alloy Steel, chrome plated, black tips.



Code	size	mm	L ₁ mm	L ₂ mm	△△ g	
46 50 31 15	T15	3.3	250	335	52	5
46 50 31 20	T20	3.8	250	355	64	5
46 50 31 25	T25	4.4	250	355	66	5
46 50 31 30	T30	5.5	250	365	122	5

4656 TORX® screwdrivers DRALL⁺

with hollow point (TORX® TAMPER RESISTANT), Chrome Alloy Steel, chrome plated, black tips.

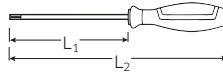

Code	size	mm	L ₁ mm	L ₂ mm	△△ g	
46 56 30 08	T8	2.3	60	145	35	5
46 56 30 09	T9	2.5	60	145	35	5
46 56 30 10	T10	2.7	80	165	39	5
46 56 30 15	T15	3.3	80	165	39	5
46 56 30 20	T20	3.8	100	205	42	5
46 56 30 25	T25	4.4	100	205	46	5
46 56 30 27	T27	5.0	115	230	90	5
46 56 30 30	T30	5.5	115	230	90	5
46 56 30 40	T40	6.6	115	240	120	5
46 56 30 45	T45	7.8	130	255	118	5

4734 Cross-head screwdrivers DRALL

Phillips-Recess®, DIN ISO 8764-1, -2, ISO 8764-1, -2, stubby, Chrome Alloy Steel, chrome plated, black tips.



Code	PH size	L ₁ mm	L ₂ mm	△△ g	
47 34 10 01	1	25	80	27	10
47 34 10 02	2	25	80	31	10

4744 Cross-head screwdrivers DRALL

POZIDRIV/SUPADRIV®, DIN ISO 8764-1, -2, ISO 8764-1, -2, stubby, Chrome Alloy Steel, chrome plated, black tips.



Code	PZ size	L ₁ mm	L ₂ mm	△△ g	
47 44 10 01	1	25	80	28	10
47 44 10 02	2	25	80	34	10

10507N KK Ball ended hexagon drivers DRALL⁺

for use on hexagon socket head screws, swivel angle up to 25° each side, Chrome Alloy Steel, chrome plated, black tips.



Code	mm	L ₁ mm	L ₂ mm	△△ g	
73 10 30 03	3	300	385	56	5
73 10 30 05	5	300	415	132	5

12500N Nut spinners DRALL⁺

DIN 3125, Chrome Vanadium, chrome plated.



Code	mm	L ₁ mm	L ₂ mm	g	
43 09 3004	4	125	230	58	10
43 09 3045	4.5	125	230	49	10
43 09 3005	5	125	230	58	10
43 09 3055	5.5	125	230	58	10
43 09 3006	6	125	240	98	10
43 09 3007	7	125	240	114	10
43 09 3008	8	125	240	115	10
43 09 3009	9	125	240	118	10
43 09 3010	10	125	240	122	10
43 09 3011	11	125	250	160	5
43 09 3012	12	125	250	168	5
43 09 3013	13	125	250	170	5

12506 Nut spinners DRALL⁺

flexible, max. torque 8 N·m, matt chrome plated.



Code	mm	L ₁ mm	L ₂ mm	g	
43 10 3206	6	150	265	167	10
43 10 3207	7	150	265	168	10
43 10 3208	8	150	265	170	10

ES 12500N/7



175 x 350 x 39 mm, 7 pieces

Code	g
96 83 8300	1060

No 12500N	sizes 7; 8; 9; 10; 11; 12; 13 mm
83 81 3085	Empty tray 99

TCS 12500N/5



TCS



175 x 350 x 45 mm, 5 pieces

Code	g
96 83 8757	730

No 12500N	sizes 7; 8; 10; 12; 13 mm
-----------	---------------------------

4691/7 DRALL⁺ set of screwdrivers

Set of 7 DRALL⁺ screwdrivers.

Content:

- ⊖ 4620: size 1 (0.6 x 3.5 x 75 mm)
- size 2 (0.8 x 4.0 x 100 mm)
- size 3 (1.0 x 5.5 x 125 mm)
- size 4 (1.2 x 6.5 x 150 mm)
- ⊖ 4628: size 1 (0.4 x 2.5 x 60 mm)
- ⊕ 4630: size 1; size 2



Code	g	
96 46 9115	610	1

4692/8 DRALL⁺ set of screwdrivers

Set of 8 DRALL⁺ screwdrivers.

Content:

- ⊖ 4620: size 1 (0.6 x 3.5 x 75 mm)
- size 2 (0.8 x 4.0 x 100 mm)
- size 3 (1.0 x 5.5 x 125 mm)
- size 4 (1.2 x 6.5 x 150 mm)
- size 5 (1.6 x 8.0 x 175 mm)
- ⊕ 4630: size 1; size 2; size 3



Code	g	
96 46 9215	870	1

4693/9 DRALL⁺ set of screwdrivers

Set of 9 DRALL⁺ screwdrivers.

Content:

- ⊖ 4622: size 1 (1.0 x 5.5 x 100 mm)
- size 2 (1.2 x 6.5 x 125 mm)
- size 3 (1.2 x 8.0 x 150 mm)
- size 4 (1.6 x 10.0 x 175 mm)
- ⊖ 4628: size 1 (0.4 x 2.5 x 60 mm)
- ⊕ 4632: size 1; size 2
- ⊖ 4724: size 2 (1.0 x 5.5 x 25 mm)
- ⊕ 4734: size 2



Code	g	
96 46 9315	950	1

4696/6 DRALL⁺ set of screwdrivers

Set of 6 DRALL⁺ screwdrivers with an impact cap.

Content:

- ⊖ 4622SK: size 1 (0.8 x 4.0 x 90 mm)
- size 2 (1.0 x 5.5 x 100 mm)
- size 3 (1.2 x 6.5 x 125 mm)
- size 4 (1.2 x 8.0 x 150 mm)
- ⊕ 4632SK: size 1; size 2



Code	g	
96 46 9615	870	1

Screwdrivers

4697/8 DRALL+ set of screwdrivers

Set of 8 **DRALL+** screwdrivers.
Content:

- ⊖ 4620: size 1 (0.6 x 3.5 x 75 mm)
size 2 (0.8 x 4.0 x 100 mm)
- ⊖ 4622: size 1 (1.0 x 5.5 x 100 mm)
size 2 (1.2 x 6.5 x 125 mm)
size 3 (1.2 x 8.0 x 150 mm)
- ⊕ 4732: size 1; size 2; size 3



Code	△△ g	📦
96 46 97 15	930	1

4694/9 DRALL+ set of TORX® screwdrivers

Set of 9 **DRALL+** screwdrivers for TORX® screws.
Content:

- ⊕ 4650: T8, T9, T10, T15, T20, T25, T27, T30, T40



Code	△△ g	📦
96 46 94 15	730	1

4699/9 DRALL+ set of TORX® screwdrivers

Set of 9 **DRALL+** screwdrivers for TORX® screws (TORX® TAMPER RESISTANT).
Content:

- ⊕ 4656: T8, T9, T10, T15, T20, T25, T27, T30, T40 (with hollow point)



Code	△△ g	📦
96 46 99 15	740	1

TCS 4620/4630





TCS



175 x 350 x 35 mm, 7 pieces

Code	△△ g
96 83 82 78	590

 No 4620	size 1 (0.6 x 3.5 x 75 mm) size 2 (0.8 x 4.0 x 100 mm) size 3 (1.0 x 5.5 x 125 mm) size 4 (1.2 x 6.5 x 150 mm)
 No 4630	sizes 1; 2; 3

TCS 4620/4640





TCS



175 x 350 x 40 mm, 7 pieces

Code	△△ g
96 83 87 84	410

 No 4620	size 1 (0.6 x 3.5 x 75 mm) size 2 (0.8 x 4.0 x 100 mm) size 3 (1.0 x 5.5 x 125 mm) size 4 (1.2 x 6.5 x 150 mm)
 No 4640	sizes PZ1; PZ2; PZ3

TCS 4622/4632

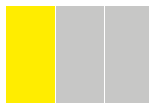



TCS



175 x 350 x 35 mm, 6 pieces

Code	△△ g
96 83 87 83	845

 No 4622	size 1 (1.0 x 5.5 x 100 mm) size 2 (1.2 x 6.5 x 125 mm) size 3 (1.2 x 8.0 x 150 mm) size 4 (1.6 x 10.0 x 175 mm)
 No 4632	sizes 2; 3

TCS 4620-4734/8







TCS



175 x 350 x 40 mm, 8 pieces

Code	△△ g
96 83 87 69	503

 No 4620	size 1 (0.6 x 3.5 x 75 mm); size 3 (1.0 x 5.5 x 125 mm); size 4 (1.2 x 6.5 x 150 mm)
 No 4628	size 1 (0.4 x 2.5 x 60 mm)
 No 4630	size 1; 2
 No 4724	size 2 (1.0 x 5.5 x 25 mm)
 No 4734	size 2

 Made in Germany

TCS 4620/4660VDE+10767



TCS



530 x 350 x 35 mm, 27 pieces

Code	g
96 83 11 68	2080
No 4620	size 1 (0.6 x 3.5 x 75 mm) size 2 (0.8 x 4.0 x 100 mm) size 4 (1.2 x 6.5 x 150 mm) size 5 (1.6 x 8.0 x 175 mm) size 6 (1.6 x 10.0 x 200 mm) size 7 (2.0 x 12.0 x 200 mm)
No 4628	size 1 (0.4 x 2.5 x 60 mm)
No 4630	size 1; 2; 3
No 4632	size 4
No 4640	size 0; 1; 2
No 4660 VDE	size 1 (0.4 x 2.5 x 75 mm)
No 4724	size 2 (1.0 x 5.5 x 25 mm)
No 4734 No 4744	size 2 size 1
No 10767/9	sizes 1.5; 2; 2.5; 3; 4; 5; 6; 8; 10 mm

TCS 4620/4660VDE



TCS

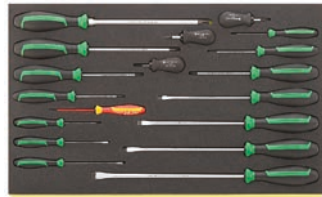

530 x 350 x 40 mm, 18 pieces

Code	g
96 83 11 79	1689
No 4620	size 1 (0.6 x 3.5 x 75 mm) size 2 (0.8 x 4.0 x 100 mm) size 4 (1.2 x 6.5 x 150 mm) size 5 (1.6 x 8.0 x 175 mm) size 6 (1.6 x 10.0 x 200 mm) size 7 (2.0 x 12.0 x 200 mm)
No 4628	sizes 1 (0.4 x 2.5 x 60 mm)
No 4630	sizes 1; 2; 3
No 4632	size 4
No 4640	sizes 0; 1; 2
No 4660 VDE	size 1 (0.4 x 2.5 x 75 mm)
No 4724	size 2 (1.0 x 5.5 x 25 mm)
No 4734 No 4744	size 2 size 1



TCS 4621/4734/16



TCS

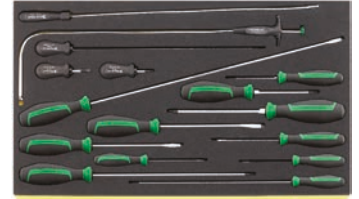

530 x 350 x 40 mm, 16 pieces

Code	g
96 83 20 98	1490
No 4621	size 0 (0.4 x 2.5 x 80 mm) size 1 (0.5 x 3.5 x 90 mm) size 2 (0.6 x 4.0 x 100 mm) size 4 (1.0 x 6.5 x 140 mm) size 5 (1.2 x 8.0 x 160 mm)
No 4631	sizes 1; 2
No 4632	sizes 1; 2; 3
No 4724	size 2 (1.0 x 5.5 x 25 mm)
No 4734	size 2
No 10506	0.8 x 4.0 x 300 mm
No 10518	1.0 x 5.5 x 410 mm
No 12600	500 g
No 12922E	∅ 6 mm

TCS 4622/4650+10760+10766



TCS



530 x 350 x 40 mm, 36 pieces

Code	g
96 83 11 96	1895
No 4622	size 1 (1.0 x 5.5 x 100 mm) size 2 (1.2 x 6.5 x 125 mm) size 4 (1.6 x 10.0 x 175 mm) size 5 (2.0 x 12.0 x 200 mm)
No 4630	size 1
No 4632	size 3
No 4650	sizes T6; T7; T8; T9; T10; T15; T20; T25; T27; T30
No 4724	size 2 (1.0 x 5.5 x 25 mm)
No 4734	size 2
No 10760CV/9	sizes 1.5; 2; 2.5; 3; 4; 5; 6; 8; 10 mm
No 10766/9	sizes T8; T9; T10; T15; T20; T25; T27; T30; T40

TCS 4650

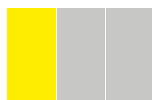

TCS



175 x 350 x 35 mm, 8 pieces

Code	g
96 83 87 67	340
No 4650	size T8; T9; T10; T15; T20; T25; T27; T30



The power is where you put it with the **3K DRALL®** screwdriver series

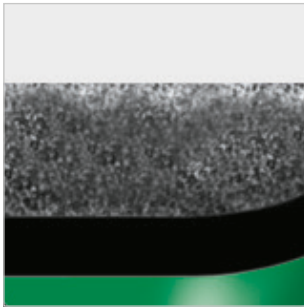

The efficiency with which you use a screwdriver in your daily work, and the safety with which you work, depend to a large extent on the quality of the tool. It is not just the use of high-grade materials but also the shape that matters - in particular the shape of the handles - if you want to stay in control. STAHLWILLE's **3K DRALL®** screwdrivers unite these positive qualities in a manner which is close to perfect. The result is a longlife, ergonomically designed tool providing easy working combined with maximum force transmission - even with greasy hands.

3K DRALL® screwdrivers are available in sets conveniently positioned in plastic inlays or TCS safety inlays, designed for use with STAHLWILLE Tool Trolleys and Tool Boxes.



1

3K DRALL® handles are made up of 3 components:

1st component - Extremely resistant, impact-safe core made of black polypropylene (PP).

2

2nd component - Soft, heat-bonded inlay made of easy-to-grip thermoplastic elastomer (TPE).

3

3rd component - Two large surfaces coated with special fibres, resistant long-term to solvents to improve force transmission and work safety.

4

Additional Tommy-bar hole - When things get really tough, the additional Tommy-bar hole will cope with a fair amount of torque.



Blades - Made of high-grade Chrome Alloy Steel. Through-hardened. Anchored firmly in the haft due to the extra-wide, forged tang. High resistance to bending.



Tips - Black, extremely tough, retain their shape. Whether you use the straight-bladed or Phillips type - the crosshatched blade tips will accurately transmit maximum force to the screw head.

4820 3K DRALL® screwdrivers for slotted screws

DIN 5265, ISO 2380, Chrome Alloy Steel, matt chrome plated, black tips.



Code	a mm	b mm	L ₁ mm	L ₂ mm	⚖️ g	📦
48 20 1035	0.6	3.5	75	170	23	10
48 20 1040	0.8	4.0	100	195	32	10
48 20 2055	1.0	5.5	125	220	58	10
48 20 1065	1.2	6.5	150	265	100	10
48 20 1080	1.6	8.0	175	290	118	10
48 20 1100	1.6	10.0	200	315	158	5
48 20 2100	2.0	12.0	250	375	218	5

4830 3K DRALL® cross-head screwdrivers

Phillips-Recess®, DIN 5262, ISO 8764, Chrome Alloy Steel, matt chrome plated, black tips.



Code	PH size	L ₁ mm	L ₂ mm	⚖️ g	📦
48 30 1000	0	60	155	28	10
48 30 1001	1	80	175	33	10
48 30 1002	2	100	215	70	10
48 30 1003	3	150	275	126	5
48 30 1004	4	200	325	251	5

4840 3K DRALL® cross-head screwdrivers

POZIDRIV/SUPADRIV®, DIN 5262, ISO 8764, Chrome Alloy Steel, matt chrome plated, black tips.



Code	PZ size	L ₁ mm	L ₂ mm	⚖️ g	📦
48 40 1001	1	80	175	33	10
48 40 1002	2	100	215	70	10

4856 3K DRALL® TORX® screwdrivers

with hollow point (TORX® TAMPER RESISTANT), Chrome Alloy Steel, matt chrome plated, black tips.



Code	size	mm	L ₁ mm	L ₂ mm	⚖️ g	📦
48 56 0006	T6*	1.6	50	145	45	5
48 56 0007	T7	2.0	50	145	37	5
48 56 0008	T8	2.3	60	155	39	5
48 56 0009	T9	2.5	60	155	50	5
48 56 0010	T10	2.7	80	175	26	5
48 56 0015	T15	3.3	80	175	52	5
48 56 0020	T20	3.8	100	215	32	5
48 56 0025	T25	4.4	100	215	55	5
48 56 0027	T27	5.0	115	230	58	5
48 56 0030	T30	5.5	115	230	63	5
48 56 0040	T40	6.6	115	240	86	5

* without hollow point

4891 3K DRALL® set of screwdrivers

Set of 6 3K DRALL® screwdrivers.

Content:

- ⊖ 4820: 0.6 x 3.5 x 75 mm
- 0.8 x 4.0 x 100 mm
- 1.0 x 5.5 x 125 mm
- 1.2 x 6.5 x 150 mm

⊕ 4830: size 1; size 2



Code	⚖️ g	📦
96 48 91 10	530	1

4892 3K DRALL® set of screwdrivers

Set of 8 3K DRALL® screwdrivers

Content:

- ⊖ 4820: 0.6 x 3.5 x 75 mm
- 0.8 x 4.0 x 100 mm
- 1.0 x 5.5 x 125 mm
- 1.2 x 6.5 x 150 mm
- 1.6 x 8.0 x 175 mm

⊕ 4830: size 1; size 2; size 3



Code	⚖️ g	📦
96 48 92 10	745	1

4899 3K DRALL® set of TORX® screwdrivers

Set of 9 3K DRALL® screwdrivers for TORX® screws

(TORX® TAMPER RESISTANT)

Content:

- ⊕ 4856: T8; T9; T10; T15; T20; T25; T27; T30; T40 (with hollow point)



Code	⚖️ g	📦
96 48 99 10	513	1

TCS 4820/4830

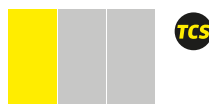

175 x 350 x 35 mm, 7 pieces



Code	⚖️ g
96 83 81 84	555

No 4820	0.6 x 3.5 x 75 mm
	0.8 x 4.0 x 100 mm
	1.0 x 5.5 x 125 mm
	1.2 x 6.5 x 150 mm
No 4830	sizes 1; 2; 3

Screwdrivers







TCS 4724/4840+10767



TCS

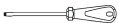

530 x 350 x 45 mm, 24 pieces

Code		♻️ g
96 83 07 06		1755
 No 4628	size 1 (0.4 x 2.5 x 60 mm)	
 No 4724	size 2 (1.0 x 5.5 x 25 mm)	
 No 4734 No 4744	size 2 size 1	
 No 4820	0.6 x 3.5 x 75 mm 0.8 x 4.0 x 100 mm 1.2 x 6.5 x 150 mm 1.6 x 10.0 x 200 mm 2.0 x 12.0 x 250 mm	
 No 4830 No 4840	sizes 1; 2; 3 size 1	
 No 10767/9	sizes 1.5; 2; 2.5; 3; 4; 5; 6; 8; 10 mm	
 No 7756		
 No 12922E	∅ 6 mm	

TCS 4856

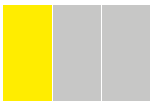

TCS



175 x 350 x 40 mm, 7 pieces

Code		♻️ g
96 83 87 55		447
 No 4856	sizes T8; T9; T10; T15; T20; T25; T30	

4798 Set of reversible screwdrivers

11 pieces

Content:

- ⊖ 0.6 x 3.5; 0.8 x 4.0; 1.0 x 5.5; 1.2 x 6.5 mm
- ⊕ sizes 1; 2
- ⊕ sizes 1; 2
- 3; 4; 5; 6 mm
- 3; 4; 5; 6 mm (ball end)
- T10; T15; T20; T25; T30; T40



Code	♻️ g	📦
96 47 98 01	745	1

Electronics Screwdrivers

4751 ⊖ Screwdrivers for slotted screws

DIN ISO 8764

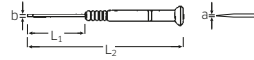

Code	size	a mm	b mm	L ₁ mm	L ₂ mm	♻️ g	📦
47 51 30 01	1	0.16	0.8	40	140	12	5
47 51 30 02	2	0.18	1.0	40	140	12	5
47 51 30 03	3	0.25	1.2	40	140	12	5
47 51 30 04	4	0.3	1.5	40	140	12	5
47 51 30 05	5	0.3	1.8	60	160	12	5
47 51 30 06	6	0.4	2.0	60	160	12	5
47 51 30 07	7	0.4	2.5	75	175	12	5
47 51 30 08	8	0.5	3.0	75	175	14	5

4752 ⊕ Cross-head screwdrivers

Phillips-Recess®, DIN ISO 2380



Code	size	L ₁ mm	L ₂ mm	⊕ M	americ. No	∅ mm	♻️ g	📦
47 52 30 10	00	40	140	-	-	2.5	12	5
47 52 30 20	0	60	160	-2	0-1	3	14	5
47 52 30 01	1	80	180	2-3	2-4	4.5	24	5

4753 ● Hexagon socket screwdrivers



Code	● mm/"	L ₁ mm	L ₂ mm	♻️ g	📦
47 53 30 07	0.7 / 0.028	40	140	12	5
47 53 30 09	0.9 / 0.035	40	140	12	5
47 53 30 13	1.3 / 0.050	40	140	12	5
47 53 30 15	1.5	50	150	12	5

4797 Electronics screwdrivers set

Bag made of extremely tough textile.

7 pieces

Content:

- ⊖ 4751: size 4 (0.3 x 1.5 x 40 mm)
size 6 (0.4 x 2.0 x 60 mm)
size 7 (0.4 x 2.5 x 75 mm)
size 8 (0.5 x 3.0 x 75 mm)
- ⊕ 4752: size 00, size 0, size 1



Code	♻️ g	📦
96 47 97 15	234	1

10768 ● T-handled screwdrivers

for socket head screws, Chrome Vanadium, matt chrome plated, black tips.



Code	mm	L ₁ mm	L ₂ mm	Δ g	
43 25 00 20	2	100	116	10	10
43 25 00 25	2.5	100	116	12	10
43 25 00 30	3	150	166	17	10
43 25 00 40	4	150	175	43	10
43 25 00 50	5	200	225	63	10
43 25 00 60	6	200	225	78	10
43 25 00 80	8	200	235	150	5
43 25 01 00	10	200	235	210	5

ES 10768/6



350 x 350 x 37 mm, 6 pieces

Code	Δ g
96 83 81 19	780

No 10768	sizes 3; 4; 5; 6; 8; 10 mm	
83 81 20 42	Empty tray	209

TCS 10768/8



TCS

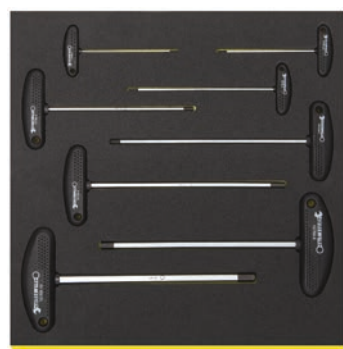

350 x 350 x 40 mm, 8 pieces

Code	Δ g
96 83 87 86	745

No 10768	sizes 2; 2.5; 3; 4; 5; 6; 8; 10 mm
----------	------------------------------------

10768-2K ● Hexagon key wrenches

with 2-component T-handle, for socket head screws, with two tips, Chrome Vanadium, matt chrome plated, black tips.



Code	mm	L ₁ mm	L ₂ mm	Δ g	
43 25 20 20	2	100	125	33	10
43 25 20 25	2.5	100	125	42	10
43 25 20 30	3	150	174	42	10
43 25 20 40	4	150	176	51	10
43 25 20 50	5	200	227	73	10
43 25 20 60	6	200	228	92	10
43 25 20 80	8	200	235	178	5
43 25 21 00	10	200	235	247	5

TCS 10768-2K/6



TCS

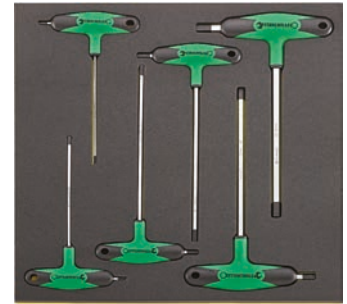

350 x 350 x 40 mm, 6 pieces

Code	Δ g
96 83 87 53	792

No 10768-2K	sizes 3; 4; 5; 6; 8; 10 mm
-------------	----------------------------

10769 ● TORX®-T-handled screwdrivers

for inside TORX® screws, shaft nickel-plated and chrome plated, tips hardened, Chrome Vanadium, matt chrome plated, black tips.



Code	size	mm	L ₁ mm	L ₂ mm	Δ g	
43 29 00 08	T8	2.3	80	96	12	5
43 29 00 09	T9	2.5	80	96	13	5
43 29 00 10	T10	2.7	100	116	14	5
43 29 00 15	T15	3.3	100	116	16	10
43 29 00 20	T20	3.8	100	125	36	10
43 29 00 25	T25	4.4	110	135	41	10
43 29 00 27	T27	5	110	135	49	10
43 29 00 30	T30	5.5	130	155	59	10
43 29 00 40	T40	6.6	130	165	102	10
43 29 00 45	T45	7.8	130	165	119	10
43 29 00 50	T50	8.8	130	165	137	5

Screwdrivers

ES 10769/7



175 x 350 x 35 mm, 7 pieces

Code	Δ g
96 83 81 20	430



No 10769

sizes T10; T15; T20; T25; T27; T30; T40

83 81 20 43	Empty tray	116
--------------------	------------	-----

ES 10769B/7



175 x 350 x 35 mm, 7 pieces

Code	Δ g
96 83 81 29	450



No 10769B

sizes T10; T15; T20; T25; T27; T30; T40

83 81 20 43	Empty tray	116
--------------------	------------	-----

TCS 10769+10771/17



350 x 350 x 30 mm, 17 pieces

Code	Δ g
96 83 20 99	940



No 10769

sizes T9; T10; T15; T20; T25; T30; T40; T45; T50



No 10771/8

sizes T9; T10; T15; T20; T25; T27; T30; T40

10769B

TORX® screwdrivers with hollow point

with hollow point (TORX® TAMPER RESISTANT), shaft nickel-plated and chrome plated, tips hardened, Chrome Vanadium, matt chrome plated, black tips.



Code	size	mm	L ₁ mm	L ₂ mm	Δ g	
43 30 00 10	T10	2.7	100	116	14	5
43 30 00 15	T15	3.3	100	116	16	5
43 30 00 20	T20	3.8	100	125	36	5
43 30 00 25	T25	4.4	110	135	41	5
43 30 00 27	T27	5.0	110	135	49	5
43 30 00 30	T30	5.5	130	155	59	5
43 30 00 40	T40	6.6	130	165	102	5

12507-2K

T-handled nut spinners

with 2-component T-handle, Chrome Vanadium, matt chrome plated.

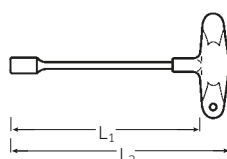

Code	\varnothing mm	L ₁ mm	L ₂ mm	Δ g	
43 23 20 60	6	200	224	83	10
43 23 20 70	7	200	234	133	10
43 23 20 80	8	200	234	135	10
43 23 20 90	9	200	234	137	10
43 23 21 00	10	200	234	141	10
43 23 21 10	11	200	240	169	5
43 23 21 20	12	200	240	171	5
43 23 21 30	13	200	240	176	5

TCS 12507-2K/5



175 x 350 x 40 mm, 5 pieces

Code	Δ g
96 83 87 61	792



No 12507-2K

sizes 7; 8; 10; 12; 13 mm

TCS 10765/10768/12507/19



TCS



530 x 350 x 30 mm, 19 pieces

Code	⚖ g
96 83 06 21	1640



No 10765/9 sizes 1.5; 2; 2.5; 3; 4; 5; 6; 8; 10 mm



No 10768 sizes 2.5; 3; 4; 5; 6; 8; 10 mm



No 12507-2K sizes 8; 10; 13 mm

10546 Offset screwdrivers

DIN 5200, for slotted screws, centre handle covered with impact proof plastic, Chrome Vanadium, chrome plated.



Code	size	a mm	b mm	L mm	⚖ g	
73 27 2001	1	0.6	3.5	90	9	10
73 27 2002	2	0.8	4	100	12	10
73 27 2003	3	1	5.5	125	29	10
73 27 2004	4	1.2	8	150	69	10

10551 Offset screwdrivers

DIN 5208, for recessed head screws, Phillips-Recess®, centre handle covered with impact proof plastic, Chrome Vanadium, chrome plated.



Code	PH size	L mm	⚖ g	
73 28 20 12	1 x 2	125	29	10
73 28 20 23	2 x 3	150	73	10

Made in Germany

10760CV Hexagon key wrenches

DIN ISO 2936 (metric), for socket head screws, Chrome Vanadium, nickel-plated (sizes 0.7; 0.9; 1.3 mm, gunmetal finish).

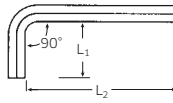

Code	⚙ mm	L ₁ mm	L ₂ mm	⚖ g	
43 15 00 70	0.7	8	32	1	10
43 15 00 90	0.9	10	32	1	10
43 15 01 30	1.3	12	40	1	10
43 15 01 50	1.5	14	45	1	10
43 15 00 02	2	16	50	2	10
43 15 02 50	2.5	18	56	3	10
43 15 00 03	3	20	63	4	10
43 15 03 50	3.5	22	66	7	10
43 15 00 04	4	25	70	10	10
43 15 00 05	5	28	80	18	10
43 15 00 06	6	32	90	29	10
43 15 00 07	7	34	95	42	10
43 15 00 08	8	36	100	59	10
43 15 00 09	9	38	105	80	10
43 15 00 10	10	40	112	103	10
43 15 00 11	11	42	119	130	10
43 15 00 12	12	45	125	169	5
43 15 00 14	14	56	140	261	5
43 15 00 17	17	63	160	442	5
43 15 00 19	19	70	180	603	5
43 15 00 22	22	80	200	938	1
43 15 00 24	24	90	224	1248	1
43 15 00 27	27	100	250	1692	1
43 15 00 30	30	112	280	2434	1
43 15 00 32	32	125	315	3117	1
43 15 00 36	36	140	355	4430	1

10760aCV Hexagon key wrenches

Code	⚙ "	L ₁ mm	L ₂ mm	⚖ g	
43 15 00 70	0.028	8	32	1	10
43 15 00 90	0.035	10	32	1	10
43 15 01 30	0.050	12	40	1	10
43 55 00 03	3/64	14	45	1	10
43 55 00 04	1/16	15	45	1	10
43 55 00 05	5/64	16	50	2	10
43 55 00 06	3/32	17	51	3	10
43 55 00 07	7/64	20	54	4	10
43 55 00 08	1/8	22	57	5	10
43 55 00 09	9/64	23	63	7	10
43 55 00 10	5/32	25	65	10	10
43 55 00 12	3/16	29	70	15	10
43 55 00 14	7/32	32	80	23	10
43 55 00 16	1/4	32	87	32	10
43 55 00 18	9/32	35	95	45	10
43 55 00 20	5/16	40	98	59	10
43 55 00 22	11/32	41	105	75	10
43 55 00 24	3/8	45	110	95	10
43 55 00 28	7/16	48	124	143	10
43 55 00 32	1/2	50	133	201	5
43 55 00 34	9/16	57	152	292	5
43 55 00 36	5/8	59	160	380	5
43 55 00 40	3/4	70	180	605	5
43 55 00 44	7/8	80	200	945	1

Screwdrivers

10760CV Hexagon key wrenches

in holder, DIN ISO 2936 (metric), for socket head screws, Chrome Vanadium, nickel-plated.



Code	No	g	g	g
96 43 15 01	10760CV/9 ¹⁾	252	1	
96 43 55 04	10760aCV/10T ²⁾	269	1	
96 43 55 02	10760aCV/13 ³⁾	126	1	

¹⁾ Content: 1.5; 2; 2.5; 3; 4; 5; 6; 8; 10 mm

²⁾ Content: 1/16; 5/64; 3/32; 1/8; 5/32; 3/16; 7/32; 1/4; 5/16; 3/8" (in plastic-wallet)

³⁾ Content (in two holders): 0.028; 0.035; 0.050; 1/16; 5/64; 3/32; 7/64; 1/8; 9/64; 5/32; 3/16; 7/32; 1/4"

10765 Hexagon key wrenches

DIN ISO 2936, for socket head screws, extra long, Chrome Vanadium, nickel-plated.



Code	mm	L ₁ mm	L ₂ mm	g	g
43 21 00 15	1.5	14	90	3	10
43 21 00 02	2	16	100	3	10
43 21 00 25	2.5	18	112	5	10
43 21 00 03	3	20	126	9	10
43 21 00 04	4	25	140	17	10
43 21 00 05	5	28	160	31	10
43 21 00 06	6	32	180	50	10
43 21 00 07	7	34	190	74	10
43 21 00 08	8	36	200	100	10
43 21 00 09	9	38	210	134	10
43 21 00 10	10	40	224	179	10
43 21 00 12	12	45	250	287	5
43 21 00 14	14	56	280	440	5
43 21 00 17	17	63	320	742	5
43 21 00 19	19	70	360	1048	5

10765/9 Hexagon key wrenches

for socket head screws, DIN ISO 2936, extra long, in holder, Chrome Vanadium, nickel-plated.

Content:

1.5; 2; 2.5; 3; 4; 5; 6; 8; 10 mm



Code	g	g
96 43 21 01	414	5

10766 Key wrenches

for inside TORX® screws, Chrome Vanadium, chrome plated.



Code	size	mm	L ₁ mm	L ₂ mm	g	g
43 22 00 06	T6	1.6	16	38	2	10
43 22 00 07	T7	2.0	16	41	3	10
43 22 00 08	T8	2.3	16	44	3	10
43 22 00 09	T9	2.5	16	48	3	10
43 22 00 10	T10	2.7	17	51	3	10
43 22 00 15	T15	3.3	18	54	5	10
43 22 00 20	T20	3.8	19	57	7	10
43 22 00 25	T25	4.4	20	60	9	10
43 22 00 27	T27	5.0	21	64	15	10
43 22 00 30	T30	5.5	24	70	20	10
43 22 00 40	T40	6.6	26	76	29	10
43 22 00 45	T45	7.8	29	83	42	10
43 22 00 50	T50	8.8	32	95	61	10
43 22 00 55	T55	11.2	35	108	122	10
43 22 00 60	T60	13.2	38	120	185	10

10766 Key wrenches

for inside TORX® screws, in holder, Chrome Vanadium, chrome plated.



Code	No	g	g
96 43 22 01	10766/6 ¹⁾	105	1
96 43 22 02	10766/9 ²⁾	120	1

¹⁾ Content: sizes T15; T20; T25; T27; T30; T40

²⁾ Content: sizes T8; T9; T10; T15; T20; T25; T27; T30; T40

10771 Key wrenches

for inside TORX® screws, extra long, with ball end on long arm, swivel angle up to 25° each side, Chrome Vanadium, gunmetal finish.



Code	size	mm	L ₁ mm	L ₂ mm	g	g
43 27 00 10	T10	2.7	23	121	10	5
43 27 00 15	T15	3.3	27	136	10	5
43 27 00 20	T20	3.8	29	148	20	5
43 27 00 25	T25	4.4	33	163	24	5
43 27 00 27	T27	5.0	36	176	28	5
43 27 00 30	T30	5.5	38	191	30	5
43 27 00 40	T40	6.6	43	210	35	5

10771/8 Key wrenches

for inside TORX® screws, extra long, with ball end on long arm, swivel angle up to 25° each side, in holder, Chrome Vanadium, gunmetal finished.

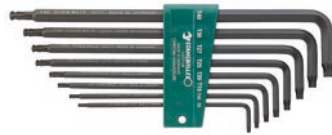

Content: sizes T9; T10; T15; T20; T25; T27; T30; T40

Code	g	
96 43 27 01	290	1

10767 Ball ended hexagon key wrenches

for hexagon socket head screws, with ball end on long arm, swivel angle up to 25° each side, Chrome Vanadium, gunmetal finish.



Code	mm	L ₁ mm	L ₂ mm	g	
43 57 01 30	1.3	12	72	1	10
43 26 00 15	1.5	14	89	2	10
43 26 00 02	2	16	99	3	10
43 26 00 25	2.5	18	112	5	10
43 26 00 03	3	20	124	8	10
43 26 00 04	4	25	138	17	10
43 26 00 05	5	28	158	30	10
43 26 00 06	6	32	178	50	10
43 26 00 08	8	36	198	99	10
43 26 00 10	10	40	222	175	10
43 26 00 12	12	45	248	280	10

10767a Ball ended hexagon key wrenches

Code	"	L ₁ mm	L ₂ mm	g	
43 57 01 30	0.050	12	72	1	10
43 57 00 04	1/16	14	78	2	10
43 57 00 05	5/64	16	87	4	10
43 57 00 06	3/32	18	99	5	10
43 57 00 07	7/64	20	108	8	10
43 57 00 08	1/8	20	119	10	10
43 57 00 09	9/64	23	132	13	10
43 57 00 10	5/32	25	145	17	10
43 57 00 12	3/16	26	159	26	10
43 57 00 14	7/32	29	170	39	10
43 57 00 16	1/4	31	184	60	10
43 57 00 20	5/16	36	202	100	10
43 57 00 24	3/8	38	222	157	10

10767 Ball ended hexagon key wrenches

in holder, Chrome Vanadium, gunmetal finish.



Code	No	g	
96 43 26 01	10767/9¹⁾	411	5
96 43 57 01	10767a/8²⁾	280	1
96 43 57 02	10767a/13³⁾	465	1

¹⁾ Content: 1.5; 2; 2.5; 3; 4; 5; 6; 8; 10 mm

²⁾ Content: 5/64; 3/32; 1/8; 5/32; 3/16; 7/32; 1/4; 5/16"

³⁾ Content: 0.050; 1/16; 5/64; 3/32; 7/64; 1/8; 9/64; 5/32; 3/16; 7/32; 1/4; 5/16; 3/8"

10767H Ball ended hexagon key wrenches

for hexagon key wrenches, swivel angle up to 25° each side, with ball end on long arm, facilitates quick, safe work in awkward places, screws stay on the head once attached, Chrome Vanadium, gunmetal finish.



Code	mm	L ₁ mm	L ₂ mm	g	
46 23 10 03	3	20	126	8	10
46 23 10 04	4	25	140	17	10
46 23 10 05	5	28	160	30	10
46 23 10 06	6	32	180	50	5
46 23 10 08	8	36	200	100	5
46 23 10 10	10	40	224	175	5

10767H/9 Set: Ball ended hexagon key wrenches

for recessed hexagonal screws, swivel angle up to 25° each side, from size 3 mm with ring, with ball end on long arm, facilitates quick, safe work in awkward places, screws stay on the head once attached, in holder, Chrome Vanadium, gunmetal finish. Content: 1.5; 2; 2.5; 3; 4; 5; 6; 8; 10 mm



Code	g	
96 43 26 02	401	5

10757 Four-sided bradawl

for punching and preparing leather, plastics and other soft materials and for marking holes in wood to prevent wood screws slipping off the mark.



Code	L mm	Blade mm	g	
77 59 30 00	215	6 x 100	100	1

10758 Round-shank bradawl NEW

for punching and preparing leather, plastics and other soft materials and for marking holes in wood to prevent wood screws slipping off the mark.



Code	L mm	Blade mm	g	
77 59 20 00	215	6 x 100	82	1

10554 EURO voltage tester

built to conform to the new EN standard, tested to conform to the currently valid VDE GS standard, with plastic handle, AC 125-250 V.



Code	a mm	b mm	L mm	g	
77 45 00 01	1	3.5	190	37	10



7 | PLIERS

COMBINATION PLIERS, FLAT NOSE PLIERS,
ROUND NOSE PLIERS, SNIPE NOSE PLIERS
→ PAGE 253



CIRCLIP PLIERS
→ PAGE 258



WATERPUMP PLIERS, PIPE WRENCHES
→ PAGE 260



SELF GRIP WRENCHES
→ PAGE 262



WIRE TWISTING PLIERS, CONNECTOR PLIERS
→ PAGE 2664



SIDE CUTTERS, OBLIQUE CUTTER,
TOP CUTTERS
→ PAGE 265



PLASTIC SIDE-CUTTERS
→ PAGE 267



WIRE STRIPPING PLIERS, CABLE SHEAR,
CRIMPING PLIERS, VARIOUS CUTTING PLIERS
→ PAGE 268



SETS OF TOOLS
→ PAGE 271



ELECTRONICS PLIERS
→ PAGE 273





Accurate. Strong. Dependable. STAHLWILLE pliers, cutters and wrenches

For accurate work and a powerful grip – with comfy-fit multi-component handles.

When you are working with pliers, your hand needs optimum support and protection in the places where the pressure exerted on the hand is felt most keenly – through ergonomic handle design. STAHLWILLE has integrated softer layers in these sections of the handles. In this way, they fulfil two important functions. They prevent the hand slipping off the handle and, at the same time, absorb the shock produced when hard wires are cut. Even with oily or greasy hands, the textured surface ensures you still have a good grip on things. The special plastic we have used is also resistant to aggressive fluids and, at the end of the lifecycle, can be properly disposed of, because it does not contain PVC.



1

Accurate gripping! By using high-grade materials and applying our sophisticated manufacturing techniques, we are able to achieve remarkable accurately shaped jaws.

2

Clean, effortless cutting! Thanks to specially hardened, high-precision cutters.

3

Strain-free working and longer tool lifetimes! Thanks to smooth-action lap-joints.

4

Prevents injuries! The anti-slip protection prevents your hands slipping off towards the jaws.

5

Longer tool lifetime and resistance to aggressive fluids! Thanks to impact-resistant, extremely hard-wearing special plastic.

6

No pinch marks and strain-free working! The ergonomically positioned softer layers improve force transmission.

Combination Pliers

6501 Combination pliers

DIN ISO 5746, precision cutting edges for all wires, incl. piano wire, induction hardened cutting edges, approx. 62 HRC, for long life.



6501 3 160



6501 5 160



6501 6 160

Code	L mm	Head	Handles	③	④	⑤	⑥	△ g
6501 3 160	160	polished	multi-component handles with softer layers	1.8	1.5	10	16	183
6501 3 180	180			2	1.8	12	16	226
6501 3 200	200			2.5	2	13	16	312
6501 5 160	160	chrome plated	multi-component handles with softer layers	1.8	1.5	10	16	210
6501 5 180	180			2	1.8	12	16	235
6501 5 200	200			2.5	2	13	16	368
6501 6 160	160	polished	dip-coated with sure-grip surface	1.8	1.5	10	16	165
6501 6 180	180			2	1.8	12	16	190
6501 6 200	200			2.5	2	13	16	288

③ Cutting capacity in mm for hard wire

④ Cutting capacity in mm for piano wire

⑤ Cutting capacity in mm for cable

⑥ Cutting capacity in mm² for cable

Flat Nose Pliers

6507 Flat nose pliers, short

DIN ISO 5745, short, flat serrated jaws.



6507 5 160



6507 6 160

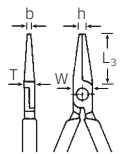

Code	L mm	Head	Handles	L ₃ mm	W mm	T mm	h mm	b mm	△ g
6507 5 160	160	chrome plated	multi-component handles with softer layers	30	17	10	5	9	180
6507 6 160	160	polished	dip-coated with sure-grip surface	30	17	10	5	9	151

6508 Flat nose pliers, long

DIN ISO 5745, long, flat serrated jaws.



6508 5 160



6508 6 160

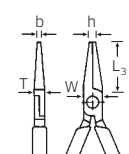

Code	L mm	Head	Handles	L ₃ mm	W mm	T mm	h mm	b mm	△ g
6508 5 160	160	chrome plated	multi-component handles with softer layers	50	15	8	3	5	160
6508 6 160	160	polished	dip-coated with sure-grip surface	50	15	8	3	5	113

6509 Flat nose pliers, long, with cutter

designed for gripping and manipulating electronic components, long, thin, flat serrated jaws, induction hardened cutting edges, approx. 60 HRC, for soft and hard wires.

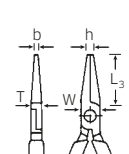

Code	L mm	Head	Handles	L ₃ mm	W mm	T mm	h mm	b mm	△ g
6509 5 160	160	chrome plated	multi-component handles with softer layers	50	15	8	3	5	164

Pliers

6510 Mechanics flat nose pliers

designed for use in fine mechanical and electronics industries, flat, slim, long serrated jaws, box joint, for long life, serrated gripping areas.

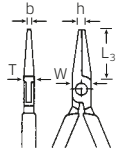

Code	L mm	Head	Handles	L ₃ mm	W mm	T mm	h mm	b mm	△△ g
65 10 5 190	190	chrome plated	dip-coated with sure-grip surface	75	13.5	8.5	2	4.5	121

6516 Mechanics flat nose pliers

designed for use by instrument mechanics, flat blunt, serrated jaws, wear resistant.

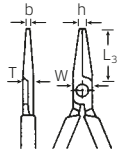

Code	L mm	Head	Handles	L ₃ mm	W mm	T mm	h mm	b mm	△△ g
65 16 5 200	200	chrome plated	dip-coated with sure-grip surface	40	13.5	9.5	2.5	9.5	158

6511 Relay pliers

DIN 5235, Form A, flat pointed, for use on contact and relay springs and on small components, smooth jaws.

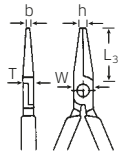

Code	L mm	Head	Handles	L ₃ mm	W mm	T mm	h mm	b mm	△△ g
65 11 5 135	140	chrome plated	dip-coated with sure-grip surface	33	13	7.5	1	1.5	72

6512 Relay pliers

DIN 5235, Form B, flat blunt, for use on contact and relay springs and on small components, smooth jaws.

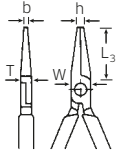

Code	L mm	Head	Handles	L ₃ mm	W mm	T mm	h mm	b mm	△△ g
65 12 5 135	140	chrome plated	dip-coated with sure-grip surface	33	13	7.5	1	3.5	78

6513 Relay pliers

DIN 5235, Form C, flat bent, 45° in line with jaws, for use on contact and relay springs and on small components, smooth jaws.

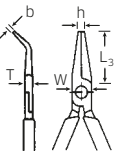

Code	L mm	Head	Handles	L ₃ mm	W mm	T mm	h mm	b mm	△△ g
65 13 5 135	140	chrome plated	dip-coated with sure-grip surface	31	13	7.5	1	3.5	78

6518 Mechanics gripping pliers

Form A, flat blunt, designed for use by instrument mechanics, wide precision jaws, smooth, tapering, box joint for precise movement.

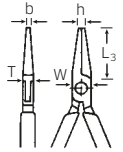

Code	L mm	Head	Handles	L ₃ mm	W mm	T mm	h mm	b mm	Δ∅ g
65 18 5 130	130	chrome plated	dip-coated with sure-grip surface	24	11.5	7	2	6.5	76

6519 Mechanics gripping pliers

Form B, flat pointed, designed for use by instrument mechanics, flat pointed precision jaws, smooth, tapering, box joint for precise movement.

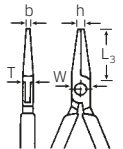

Code	L mm	Head	Handles	L ₃ mm	W mm	T mm	h mm	b mm	Δ∅ g
65 19 5 130	130	chrome plated	dip-coated with sure-grip surface	24	11.5	7	1.5	2	72

Round Nose Pliers

6523 Round nose pliers, short

DIN ISO 5745, for bending wire loops and rings, short, round, ground jaws, fine serrations on gripping areas.

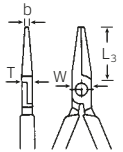

Code	L mm	Head	Handles	L ₃ mm	W mm	T mm	b mm	Δ∅ g
65 23 5 160	160	chrome plated	multi-component handles with softer layers	30	18	10	3	185

6524 Round nose pliers, long

DIN ISO 5745, for bending wire loops and rings, long, round, ground jaws, fine serrations on gripping areas.

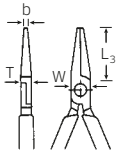

Code	L mm	Head	Handles	L ₃ mm	W mm	T mm	b mm	Δ∅ g
65 24 5 160	160	chrome plated	multi-component handles with softer layers	47	15.5	8.5	2.5	155

6525 Mechanics round nose pliers

for bending wire loops, round precision jaws, smooth, box joint for precise movement.

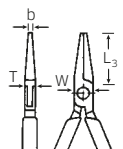

Code	L mm	Head	Handles	L ₃ mm	W mm	T mm	b mm	Δ∅ g
65 25 5 130	130	chrome plated	dip-coated with sure-grip surface	22	11.5	7	1.5	73

Pliers

Snipe Nose Pliers

6529 Snipe nose pliers with cutter (radio- or telephone pliers)

DIN ISO 5745, Form A (straight), half round, long tapering, serrated jaws, with burner hole, precision cutting edges for soft and hard wires, induction hardened cutting edges, approx. 60 HRC.



6529 3 160



6529 5 160



6529 6 160

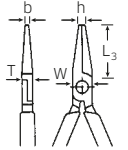

Code	L mm	Head	Handles	L ₃ mm	W mm	T mm	h mm	b mm	△ g
6529 3 145	140	polished	multi-component handles with softer layers	44	15	8	2.5	2	115
6529 3 160	160			51	16	9	3	2.5	155
6529 3 200	200			73	17	9	3	2.5	197
6529 5 145	140	chrome plated	multi-component handles with softer layers	44	15	8	2.5	2	115
6529 5 160	160			51	16	9	3	2.5	170
6529 5 200	200			73	17	9	3	2.5	220
6529 6 145	140	polished	dip-coated with sure-grip surface	44	15	8	2.5	2	92
6529 6 160	160			51	16	9	3	2.5	148
6529 6 200	200			73	17	9	3	2.5	187

6530 Snipe nose pliers with cutter (radio- or telephone pliers)

DIN ISO 5745, Form B, bent 45°, half round, long tapering, serrated jaws, with burner hole, precision cutting edges for soft and hard wires, induction hardened cutting edges, approx. 60 HRC.



6530 3 200



6530 5 200



6530 6 200

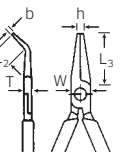

Code	L mm	Head	Handles	L ₂ mm	L ₃ mm	W mm	T mm	h mm	b mm	△ g
6530 3 160	160	polished	multi-component handles with softer layers	24	55	16	9	3	2.5	145
6530 3 200	200			28	76	17	9	3.5	2.5	198
6530 5 160	160	chrome plated	multi-component handles with softer layers	24	55	16	9	3	2.5	170
6530 5 200	200			28	76	17	9	3.5	2.5	210
6530 6 160	160	polished	dip-coated with sure-grip surface	24	55	16	9	3	2.5	146
6530 6 200	200			28	76	17	9	3.5	2.5	178

6531 Mechanics snipe nose pliers

Form A (straight), designed for use on miniature electronic and mechanical components, half round extra thin, long tapering jaws with fine serration, box joint for precise movement.

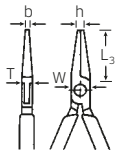

Code	L mm	Head	Handles	L ₃ mm	W mm	T mm	h mm	b mm	△ g
6531 5 170	170	chrome plated	dip-coated with sure-grip surface	63	13.5	8	2.5	2	98

6532 Mechanics snipe nose pliers

Form B, bent 45°, designed for use on miniature electronic and mechanical components, half round extra thin, long tapering jaws with fine serrations, box joint for precise movement.

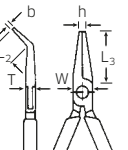

Code	L mm	Head	Handles	L ₂ mm	L ₃ mm	W mm	T mm	h mm	b mm	△ g
6532 5 170	170	chrome plated	dip-coated with sure-grip surface	24	54	13.5	8	2.5	2	102

6533 Mechanics snipe nose pliers

half round, long tapering, serrated jaws.

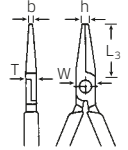

Code	L mm	Head	Handles	L ₃ mm	W mm	T mm	h mm	b mm	Δg
6533 5 160	160	chrome plated	dip-coated with sure-grip surface	50	15	8	3	2.5	129

6534 Mechanics snipe nose pliers

Form A (straight), half round, long tapering, serrated jaws.



6534 5 200



6534 5 280

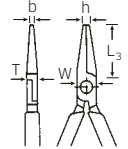

Code	L mm	Head	Handles	L ₃ mm	W mm	T mm	h mm	b mm	Δg
6534 5 200	200	chrome plated	multi-component handles with softer layers	76	16	10	3	2.5	220
6534 5 280	280	chrome plated	dip-coated with sure-grip surface	73	20	9.5	3	2.5	255

6535 Mechanics snipe nose pliers

Form B (bent 45°), half round, long tapering, serrated jaws.



6535 5 200



6535 5 280

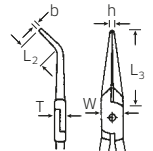

Code	L mm	Head	Handles	L ₂ mm	L ₃ mm	W mm	T mm	h mm	b mm	Δg
6535 5 200	200	chrome plated	multi-component handles with softer layers	28	68	17	9.5	3.5	2.5	220
6535 5 280	280	chrome plated	dip-coated with sure-grip surface	28	66	20	9.5	3	2.5	255

6536 Snipe nose pliers (needle pliers)

DIN ISO 9655, Form A (straight), designed for use on electronic components, half round, extra long tapering jaws, fine serration.

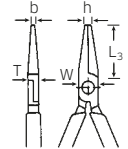

Code	L mm	Head	Handles	L ₃ mm	W mm	T mm	h mm	b mm	Δg
6536 5 160	160	chrome plated	dip-coated with sure-grip surface	58	15	8.5	4	3	110

6537 Snipe nose pliers (needle pliers)

Form B, bent 45°, designed for use on electronic components, half round, extra long tapering jaws, fine serration.

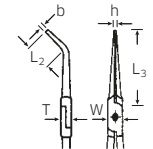

Code	L mm	Head	Handles	L ₂ mm	L ₃ mm	W mm	T mm	h mm	b mm	Δg
6537 5 160	160	chrome plated	dip-coated with sure-grip surface	25	54	14	8	1	3	115

Pliers

6538 Mechanics snipe nose pliers

designed for use on miniature mechanical components, half round tapering jaws, wear resisting serration.

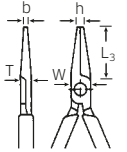

Code	L mm	Head	Handles	L ₃ mm	W mm	T mm	h mm	b mm	g
6538 5 200	200	chrome plated	dip-coated with sure-grip surface	38	13	9.5	2.5	2	157

Circlip Pliers

6543 Circlip pliers for inside circlips

DIN 5256 C, straight, H.D. drop forged, precision points.



6543 4 002



6543 6 002

Code	size	L mm	tips ∅ mm	for circlip sizes mm	Head	Handles	g
6543 4 000	J 0	140	0.9	8-13	matchrome plated	chrome plated, chequered	90
6543 4 001	J 1	140	1.3	12-25			90
6543 4 002	J 2	180	1.8	19-60			135
6543 4 003	J 3	225	2.3	40-100			195
6543 4 004	J 4	320	3.2	85-140			419
6543 6 000	J 0	140	0.9	8-13	polished	dip-coated with sure-grip surface	100
6543 6 001	J 1	140	1.3	12-25			100
6543 6 002	J 2	180	1.8	19-60			150
6543 6 003	J 3	225	2.3	40-100			215
6543 6 004	J 4	320	3.2	85-140			462

6544 Circlip pliers for inside circlips

DIN 5256 D, bent 90°, H.D. drop forged, precision points.



6544 4 021



6544 6 021

Code	size	L mm	tips ∅ mm	for circlip sizes mm	Head	Handles	g
6544 4 001	J 01	130	0.9	8-13	matchrome plated	chrome plated, chequered	90
6544 4 011	J 11	130	1.3	12-25			90
6544 4 021	J 21	170	1.8	19-60			135
6544 4 031	J 31	215	2.3	40-100			195
6544 4 041	J 41	300	3.2	85-140			416
6544 6 001	J 01	130	0.9	8-13	polished	dip-coated with sure-grip surface	100
6544 6 011	J 11	130	1.3	12-25			100
6544 6 021	J 21	170	1.8	19-60			150
6544 6 031	J 31	215	2.3	40-100			215
6544 6 041	J 41	300	3.2	85-140			432



6545 Circlip pliers for outside circlips

DIN 5254 A, straight,
H.D. drop forged, precision points,
with wear resistant compression spring.



Code	size	L mm	tips ∅ mm	for circlip sizes mm	Head	Handles	∅ g
6545 4 000	A 0	140	0.9	3-10	mattchrome plated	chrome plated, chequered	95
6545 4 001	A 1	140	1.3	10-25			95
6545 4 002	A 2	180	1.8	19-60			145
6545 4 003	A 3	210	2.3	40-100			205
6545 4 004	A 4	315	3.2	85-140			437
6545 6 000	A 0	140	0.9	3-10	polished	dip-coated with sure-grip surface	105
6545 6 001	A 1	140	1.3	10-25			105
6545 6 002	A 2	180	1.8	19-60			160
6545 6 003	A 3	210	2.3	40-100			232
6545 6 004	A 4	315	3.2	85-140			491

6546 Circlip pliers for outside circlips

DIN 5254 B, bent 90°,
H.D. drop forged, precision points,
with wear resistant compression spring.



Code	size	L mm	tips ∅ mm	for circlip sizes mm	Head	Handles	∅ g
6546 4 001	A 01	125	0.9	3-10	mattchrome plated	chrome plated, chequered	95
6546 4 011	A 11	125	1.3	10-25			95
6546 4 021	A 21	170	1.8	19-60			145
6546 4 031	A 31	200	2.3	40-100			111
6546 4 041	A 41	290	3.2	85-140			431
6546 6 001	A 01	125	0.9	3-10	polished	dip-coated with sure-grip surface	105
6546 6 011	A 11	125	1.3	10-25			105
6546 6 021	A 21	170	1.8	19-60			160
6546 6 031	A 31	200	2.3	40-100			236
6546 6 041	A 41	290	3.2	85-140			468

6547 Special circlip pliers for slotted circlips

for slotted circlips (as used on shafts of engines,
gearboxes, differentials, clutches etc.),
with wear resistant compression spring.



Code	L mm	Head	Handles	∅ g
6547 4 170	170	mattchrome plated	chrome plated, chequered	154
6547 6 170	170	polished	dip-coated with sure-grip surface	162

Pliers

Waterpump Pliers

6551 Waterpump pliers

DIN ISO 8976 (No 207 c), box joint, 7 adjustment positions (175 mm 6 adjustment positions), anti-squeeze protection, Chrome Vanadium.



6551 5 240



6551 6 175

Code	L mm	Jaw opening max. mm	Head	Handles	⚖ g
6551 5 240	245	34	chrome plated	multi-component handles with softer layers	365
6551 6 175	177	24	black lacquered, jaws polished	black lacquered, box frame polished, dip-coated	173
6551 6 240	240	34			330
6551 6 300	302	45			520

6572 Waterpump pliers FastGRIP

patent, box joint with dual support, fast adjustment on the work piece via push button, freely adjustable, easy super fine adjustment with 10 snap-in points (180 mm), 12 snap-in points (240 mm), 15 snap-in points (300 mm), induction hardened jaw toothing - extremely hard and durable, safety clamping protection against squeezing injuries, Chrome Vanadium.



6572 6 240

Code	L mm	Jaw opening max. mm	Head	Handles	⚖ g
6572 6 180	180	28	polished	dip-coated with sure-grip surface	236
6572 6 240	240	37			393
6572 6 300	300	44			530

6573 PowerGRIP pliers wrench

patent, box joint, fast adjustment via button press directly on the work piece, freely adjustable, easy super fine adjustment, high transmission ratio for noticeable amplification of manual force, for work pieces with parallel surfaces (nuts, screws etc.), also ideal for bending thin parallel work pieces (e.g. metal sheet), parallel jaws without profile to protect surface coated work pieces, "Ratchet effect" for screws by using the jaw stroke, extremely resistant overall construction, high quality tempered.



6573 5 300

Code	L mm	Jaw opening max. mm	Head	Handles	⚖ g
6573 5 180	192	36	chrome plated	dip-coated with sure-grip surface	291
6573 5 250	253	46			485
6573 5 300	300	60			661

6554 Waterpump pliers, with rapid adjustment

DIN ISO 8976 (No 207 c), box joint "hook" adjustment, jaw with slot, Chrome Vanadium.



6554 4 250

Code	L mm	Jaw opening max. mm	Head	Handles	⚖ g
6554 4 250	255 ¹⁾	52	chrome plated	chrome plated, chequered	476
6554 4 375	380	61			1066

¹⁾ anti-squeeze protection

6954 Spare springs for No 6554

Code	Spare spring for No	⚖ g
6954 0 002	65544250	3
6954 0 003	65544375	4

6515 MINI-waterpump pliers

NEW

Chrome Vanadium.



Code	L mm	Jaw opening max. mm	Head	Handles	Δ g
65 15 6 125	125	25	black lacquered, polished	dip-coated with sure-grip surface	118

Pipe wrenches

6549 Pipe wrenches

Type B, 45°, DIN 5234.



Code	size	L mm	Jaw opening max. mm	Head	Handles	Δ g
65 49 0 315	1	330	35	red lacquered	red lacquered	780
65 49 0 420	1 1/2	445	62			1626
65 49 0 555	2	560	78			2780

6556 Swedish pattern wrenches

Type A, 90°, DIN 5234.



Code	size	L mm	Jaw opening max. mm	Head	Handles	Δ g
65 56 0 310	1	320	44	red lacquered	red lacquered	780
65 56 0 420	1 1/2	420	64			1560
65 56 0 560	2	540	83			2676

6557 S-shaped Swedish pattern wrenches

Type C, DIN 5234.



Code	size	L mm	Jaw opening max. mm	Head	Handles	Δ g
65 57 0 320	1	330	40	red lacquered	red lacquered	811
65 57 0 416	1 1/2	440	60			1595
65 57 0 535	2	560	70			2677

6558 "Heavy Duty" pipe wrenches

US-standard GGG-W-651 Type II, category A.



Code	size	L mm	Jaw opening max. mm	Head	Handles	Δ g
65 58 0 250	10"	250	49	black lacquered	red lacquered	805
65 58 0 300	12"	300	61			1255
65 58 0 350	14"	350	61			1665
65 58 0 450	18"	450	77			2660
65 58 0 600	24"	600	90			4295

Pliers

6559 "Stillson" pipe wrenches

US-standard GGG-W-651 Type I, category A.



Code	size	L mm	Jaw opening max. mm	Head	Handles	Δ g
65 59 0 250	10"	250	35	black lacquered	red lacquered	550
65 59 0 300	12"	300	43			750
65 59 0 350	14"	350	49			1080
65 59 0 450	18"	450	61			1725
65 59 0 600	24"	600	77			3000

Self Grip Wrenches

6561 Wide jaw self grip wrench

80 mm jaw width, quick release lever,
Chrome Vanadium.



Code	L mm	S mm	Head	Handles	Δ g
65 61 2 175	175	20	bright nickel-plated	bright nickel-plated	364

6562 Parallel jaw self grip wrench

forged jaws, quick release lever,
Chrome Vanadium.



Code	L mm	S mm	Head	Handles	Δ g
65 62 2 250	250	50	bright nickel-plated	bright nickel-plated	700

6562/1 6562/2 Parallel jaw self grip wrenches

forged jaws, quick release lever, for small round
parts (V-cutout in one jaw) and also suitable for
larger workpieces, also ideal for gently gripping
sensitive workpieces, Chrome Vanadium.



6562/1



6562/2

Code	L mm	S mm	Head	Handles	Δ g
65 62 2 100	250	100	bright nickel-plated	bright nickel-plated	985
65 62 2 200	250	200			1154

6962 Plastic protective jaws for parallel jaw self grip wrenches No 6562/1 and No 6562/2

1 pair, provides additional protection for clamped workpieces.

Code	Δ g
69 62 0 001	10

6563 Universal self grip wrenches

forged jaws (one straight, one contoured), quick release lever, Chrome Vanadium.



6563 2 175

Code	L mm	S mm	Head	Handles	Δ g
6563 2 175	175	25	bright nickel-plated	bright nickel-plated	320
6563 2 250	250	30			500

6564 Self grip wrenches

forged contoured jaws, quick release lever, wire cutter, Chrome Vanadium.



6564 2 175

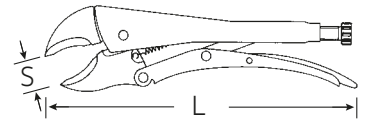

Code	L mm	S mm	Head	Handles	Δ g
6564 2 145	145	14	bright nickel-plated	bright nickel-plated	175
6564 2 175	175	30			323
6564 2 250	250	40			550
6564 2 300	300	65			977

6565 Welders self grip wrench

with quick release lever, Chrome Vanadium.



Code	L mm	S mm	Head	Handles	Δ g
6565 2 280	280	65	bright nickel-plated	bright nickel-plated	941

6566 Pipe welders self grip wrench

with quick release lever, Chrome Vanadium.



Code	L mm	S mm	Head	Handles	Δ g
6566 2 280	280	85	bright nickel-plated	bright nickel-plated	944

6567 C-Clamp self grip wrenches

with quick release lever, Chrome Vanadium.



6567 2 280

Code	L mm	S mm	Head	Handles	Δ g
6567 2 175	175	75	bright nickel-plated	bright nickel-plated	236
6567 2 280	280	85			694

Pliers

6568 Long reach grip wrenches

extra large capacity, quick release lever, Chrome Vanadium.



65 68 2 460

Code	L mm	S mm	Head	Handles	⌀ g
65 68 2 460	460	180	bright nickel-plated	bright nickel-plated	1100
65 68 2 600	600	240			1372

6571 Long nose self grip wrench

specially suitable for narrow, tapering access, with quick-release lever, Chrome Vanadium.



Code	L mm	S mm	Head	Handles	⌀ g
65 71 2 165	165	23	bright nickel-plated	bright nickel-plated	190

Wire Twisting Pliers

6575 Wire twisting pliers

for wire locking of metal fasteners, with side cutter, serrated jaws for positive grip, jaws angled by 40°, suitable for locking wires up to \varnothing 1.6 mm (dec. in. 0.06), for clockwise and anticlockwise use, with automatic return action, Chrome Vanadium.



65 75 1 220

65 75 1 280



Code	L mm	Head	Handles	⌀ g
65 75 1 220	230	gunmetal finish, polished	gunmetal finish	330
65 75 1 280	280			440

Various Gripping Pliers

6576N Connector pliers

replaceable plastic jaws, 4 adj. positions, for use on screw connections incl. Canon-connectors, or any light alloy or other tube connections, surfaces of which must not be damaged, Chrome Vanadium.



Code	L mm	Head	Handles	⌀ g
65 76 5 231	230	chrome plated	with dip-coated	288

6976 Loose plastic jaws for No 6576N

Code	⌀ g
69 76 0 001	4

Side Cutters

6600 Side cutters ✂

DIN ISO 5749, Form B, precision cutting edges for all wires incl. piano wire, high quality alloy steel, bevelled cutting edges induction hardened, approx. 63 HRC..

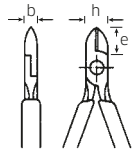

Code	L mm	Head	Handles	e mm	h mm	b mm	①	②	③	④	Δ g
6600 3 130	125	polished	multi-component handles with softer layers	24	17	8.6	2.8	2.3	1.5	1.25	110
6600 3 145	140			25.7	18.5	8.2	3	2.5	1.8	1.6	147
6600 3 160	160			29.5	22.5	9.5	3	2.8	2	1.6	188
6600 3 180	180			32	23.5	11	3.8	3	2.5	2	242
6600 5 130	125	chrome plated	multi-component handles with softer layers	24	17	8.6	2.8	2.3	1.5	1.25	105
6600 5 145	140			25.7	18.5	8.2	3	2.5	1.8	1.6	160
6600 5 160	160			29.5	22.5	9.5	3	2.8	2	1.6	190
6600 5 180	180			32	23.5	11	3.8	3	2.5	2	255
6600 6 130	125	polished	dip-coated with sure-grip surface	24	17	8.6	2.8	2.3	1.5	1.25	92
6600 6 145	140			25.7	18.5	8.2	3	2.5	1.8	1.6	121
6600 6 160	160			29.5	22.5	9.5	3	2.8	2	1.6	165
6600 6 180	180			32	23.5	11	3.8	3	2.5	2	205

① Cutting capacity in mm for soft wire
③ Cutting capacity in mm for hard wire

② Cutting capacity in mm for medium hard wire
④ Cutting capacity in mm for piano wire

6601 Side cutter ✂

as No 6600, mini bevel, fitted with double leaf spring.

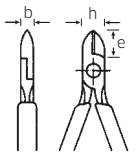

Code	L mm	Head	Handles	e mm	h mm	b mm	①	②	③	④	Δ g
6601 6 110	110	polished	dip-coated with sure-grip surface	15	15	8.5	2.5	1.5	1.2	0.8	69

① Cutting capacity in mm for soft wire
③ Cutting capacity in mm for hard wire

② Cutting capacity in mm for medium hard wire
④ Cutting capacity in mm for piano wire

6602 Heavy duty side cutters ✂

DIN ISO 5749, Form A, precision cutting edges for all wires incl. piano wire, high quality alloy steel, bevelled cutting edges induction hardened, approx. 63 HRC.

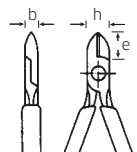

Code	L mm	Head	Handles	e mm	h mm	b mm	①	②	③	④	Δ g
6602 3 140	140	polished	multi-component handles with softer layers	23.5	20	9	4	3.1	2	1.5	156
6602 3 160	160			25.5	25	9.5	4	3.4	2.5	2	203
6602 3 180	180			27.5	26.5	10.5	4	3.8	2.7	2.2	251
6602 3 200	200			31	28	11.5	4	4	3	2.5	305
6602 3 250	250			32	29.5	12	4	4	3.5	3	407
6602 5 140	140	chrome plated	multi-component handles with softer layers	23.5	20	9	4	3.1	2	1.5	145
6602 5 160	160			25.5	25	9.5	4	3.4	2.5	2	200
6602 5 180	180			27.5	26.5	10.5	4	3.8	2.7	2.2	290
6602 5 200	200			31	28	11.5	4	4	3	2.5	310
6602 5 250	250			32	29.5	12	4	4	3.5	3	409
6602 6 140	140	polished	dip-coated with sure-grip surface	23.5	20	9	4	3.1	2	1.5	140
6602 6 160	160			25.5	25	9.5	4	3.4	2.5	2	170
6602 6 180	180			27.5	26.5	10.5	4	3.8	2.7	2.2	230
6602 6 200	200			31	28	11.5	4	4	3	2.5	260
6602 6 250	250			32	29.5	12	4	4	3.5	3	375

① Cutting capacity in mm for soft wire
③ Cutting capacity in mm for hard wire

② Cutting capacity in mm for medium hard wire
④ Cutting capacity in mm for piano wire

Pliers

Oblique Cutter

6612 Mechanics oblique cutter

suitable for use on miniature mechanical and electronic components, precision cutting edges for hard and soft wire, head angled by 28°, Cu-wire 0.25 mm \varnothing may be cut at tips, alloy steel of highest quality, induction hardened mini-bevelled cutting edges, approx. 60 HRC.

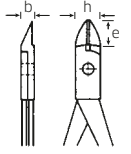

Code	L mm	Head	Handles	e mm	h mm	b mm	①	②	③	Δ g
66 12 5 185	185	chrome plated	dip-coated with sure-grip surface	14	13.5	9.5	2	1.8	1.5	145

① Cutting capacity in mm for soft wire
③ Cutting capacity in mm for hard wire

② Cutting capacity in mm for medium hard wire

Top Cutters

6618 Top cutters, heavy duty

DIN ISO 5748, precision cutting edges for all wires, incl. piano wire, alloy steel of highest quality, induction hardened bevelled cutting edges, approx. 63 HRC.



66 18 5 160



66 18 6 160

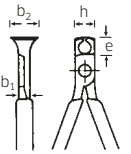

Code	L mm	Head	Handles	e mm	h mm	b ₁ mm	b ₂ mm	①	②	③	④	Δ g
66 18 5 160	160	chrome plated	multi-component handles with softer layers	17	26	11.5	24	3.8	3	2.5	2	240
66 18 6 160	160	polished	dip-coated with sure-grip surface	17	26	11.5	24	3.8	3	2.5	2	211

① Cutting capacity in mm for soft wire
③ Cutting capacity in mm for hard wire

② Cutting capacity in mm for medium hard wire
④ Cutting capacity in mm for piano wire

6617 Lever action top cutters

DIN ISO 5748, for piano wire, special steel.



66 17 0 215

Code	L mm	Head	Handles	①	②	③	④	Δ g
66 17 0 180	180	polished	black lacquered	3.5	3	2.5	2.25	394
66 17 0 215	215			4	3.5	2.8	2.5	440
66 17 0 235	235			4	3.5	3	2.75	467

① Cutting capacity in mm for soft wire
③ Cutting capacity in mm for hard wire

② Cutting capacity in mm for medium hard wire
④ Cutting capacity in mm for piano wire

Plastic side-cutters

6670 Plastic side-cutter

for plastic injection mouldings, with particularly narrow, straight cutting edges, with no bevel to enable flush trimming of sprues and burrs, only for thin sprues made of soft thermoplastic, with spring-loaded opening, induction-hardened cutting edges.

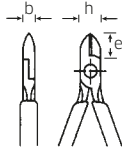

Code	L mm	Head	Handles	e mm	h mm	b mm	Δ g
6670 6 120	120	polished	dip-coated with sure-grip surface	13	11	7	56

6673 Plastic side-cutter

for plastic injection mouldings, with raised cutting edges, 20° angled, with no bevel to enable flush trimming of sprues and burrs, with spring-loaded opening, induction-hardened cutting edges.

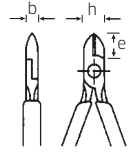

Code	L mm	Head	Handles	e mm	h mm	b mm	Δ g
6673 6 130	130	polished	dip-coated with	22	17	8.5	107
6673 6 145	145		sure-grip surface	23	18	9.5	119
6673 6 160	160			28	18	10.5	165

6671 Plastic side-cutter

for plastic injection mouldings, with particularly narrow, straight cutting edges, 45° angled, with no bevel to enable flush trimming of sprues and burrs, only for thin sprues made of soft thermoplastic, with spring-loaded opening, induction-hardened cutting edges.

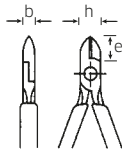

Code	L mm	Head	Handles	e mm	h mm	b mm	Δ g
6671 6 120	120	polished	dip-coated with sure-grip surface	12	11	7	56

6674 Plastic side-cutter

for plastic injection mouldings, with convex cutting edge, with no bevel to enable flush trimming of sprues and burrs, with spring-loaded opening, induction-hardened cutting edges.

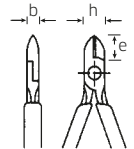

Code	L mm	Head	Handles	e mm	h mm	b mm	Δ g
6674 6 160	160	polished	dip-coated with sure-grip surface	28	20	11	162

6672 Plastic side-cutter

for plastic injection mouldings, with straight cutting edges, 20° angled, with no bevel to enable flush trimming of sprues and burrs, with spring-loaded opening, induction-hardened cutting edges.

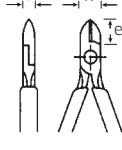

Code	L mm	Head	Handles	e mm	h mm	b mm	Δ g
6672 6 130	130	polished	dip-coated with	22	16	9	107
6672 6 145	145		sure-grip surface	25	17	10	120
6672 6 160	160			28	18	10	161

6676 Plastic side-cutter

For plastic injection mouldings, with straight cutting edges, 30° angled, with no bevel to enable flush trimming of sprues and burrs, with spring-loaded opening, induction-hardened cutting edges.

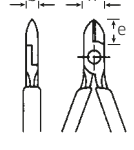

Code	L mm	Head	Handles	e mm	h mm	b mm	Δ g
6676 6 130	130	polished	dip-coated with	19	16.5	8.5	105
6676 6 145	145		sure-grip surface	21	18.5	9.5	125
6676 6 160	160			28	20	11	165

6677 Plastic side-cutter

for plastic injection mouldings, with straight cutting edges, 90° angled, with no bevel to enable flush trimming of sprues and burrs, with spring-loaded opening, induction-hardened cutting edges.

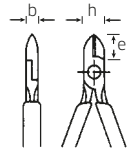

Code	L mm	Head	Handles	e mm	h mm	b mm	Δ g
6677 6 160	160	polished	dip-coated with sure-grip surface	25	21	10	166

Pliers

Wire Stripping Pliers

6622 Wire stripping pliers

with adjustment screw to cut insulation only on wire or cable, max. 5 mm Ø 10 mm² conductor cross-section.



66 22 5 160



66 22 6 160

Code	L mm	Head	Handles	⚖ g
66 22 5 160	160	chrome plated	multi-component handles with softer layers	195
66 22 6 160	160	polished	dip-coated with sure-grip surface	180

6623 Wire stripping pliers

for wires from 0.5 to 5 mm Ø, self adjusting, cutter hole for cutting wire or stranded wires up to 5 mm Ø, special steel.



Code	L mm	Head	Handles	⚖ g
66 23 5 160	160	chrome plated	multi-component handles with softer layers	180

6923 Replacement stripping knives (1 pair) for No 6623

Code	⚖ g
69 23 0 001	11

6624 Wire stripping pliers

for wires from 0.3 to 1.2 mm Ø, self adjusting, cutter hole for cutting wire or stranded wires up to 5 mm Ø, special alloy steel.



Code	L mm	Head	Handles	⚖ g
66 24 5 160	160	chrome plated	multi-component handles with softer layers	186

Cable Shear

6630 Cable shear

for copper- and light alloy cables. Easy, single handed operation. Special cutting edges geometry to avoid pressure marks and frayed ends, adjustable joint, anti-squeeze protection, not suitable for steel- or armoured cables.



Code	L mm	Head	Handles	⑦	⑧	⑨	⚖ g
66 30 5 220	220	chrome plated	dip-coated with sure-grip surface	16	35	70	332

⑦ cutting capacity in mm² for single wire Al-/Cu-Cable

⑨ cutting capacity in mm² for thin wire Al-/Cu-Cable

⑧ cutting capacity in mm² for multiple wire Al-/Cu-Cable

Crimping Pliers

6634 Crimping pliers

with half round profile, for reliable crimping of terminal sleeves DIN 46228, 8 deep slots with tapering side walls, crimping within the size marked profiles in one operation.



Code	L mm	Head	Handles	crimping range mm ²	⚖ g
66346220	220	gunmetal finish	dip-coated with sure-grip surface	0.25; 0.5; 0.75; 1; 1.5; 2.5; 4; 6; 10; 16	240

6637 Crimping pliers

for use with terminal sleeves with or without an insulating collar in accordance with DIN 46228

- high precision crimping
- easy-action force transmission coupled with simple handling
- unlockable autolock
- accurately ground profiles
- crimp shape: □



Code	L mm	Head	Handles	crimping range mm ²	⚖ g
66370195	195	gunmetal finish	with plastic sleeves	0.08 - 10	298

6638 Crimping pliers

for red/blue/yellow insulated cable lugs, pin-type cable lugs, flat plugs and sleeves, round plugs and sleeves, butt and parallel connectors

- unlockable autolock
- easy handling
- stripping and cutting device, refer to No 6966
- crimp shape: ○

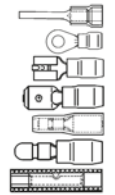

Code	L mm	Head	Handles	crimping range mm ²	⚖ g
66380220	220	gunmetal finish	with plastic sleeves	red = 0.5-1 (AWG 20-18); blue = 1.5-2.5 (AWG 16-14); yellow = 4-6 (AWG 12-10)	477

6639 Crimping pliers

for non-insulated flat plugs and flat sleeves for nominal DIN widths F2.8; F4.8; F6.3; F9.5

- unlockable autolock
- easy handling
- stripping and cutting device, refer to No 6966
- crimp shape: ☺

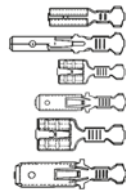

Code	L mm	Head	Handles	crimping range mm ²	⚖ g
66390220	220	gunmetal finish	with plastic sleeves	0.25-0.5 (AWG 24-20); 0.5-1 (AWG 20-18); 4-6 (AWG 12-10); 1.5-2.5 (AWG 16-14)	483

6640 Crimping pliers

for non-insulated cable lugs and tubular cable lugs with closed crimp sleeves

- unlockable autolock
- easy handling
- stripping and cutting device, refer to No 6966
- crimp shape: ☺

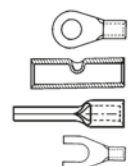

Code	L mm	Head	Handles	crimping range mm ²	⚖ g
66400220	220	gunmetal finish	with plastic sleeves	0.1-0.35 (AWG 26-22); 0.5-1 (AWG 20-18); 1.5-2.5 (AWG 16-14); 4-6 (AWG 12-10); 10-16 (AWG 8-6)	465

Pliers

6641 Crimping pliers

for use with terminal sleeves with or without an insulating collar in accordance with DIN 46228

- unlockable autolock
- easy handling
- stripping and cutting device, refer to No 6966
- crimp shape: □



Code	L mm	Head	Handles	crimping range mm ²	Δ g
66 41 0 220	220	gunmetal finish	with plastic sleeves	0.14-0.5; 0.75-1.5; 2.5; 4; 6; 10	536

6966 Stripping and cutting tool

for stripping wires from 0.5 to 6 mm Ø.

Cables can also be cut.

For use with crimping pliers No 6638, 6639, 6640 and 6641.



Code	Δ g
69 66 0 000	37

Various Cutting Pliers

6660 Steel fixers pincers

DIN ISO 9242, limit on opening angle to ensure single-handed closure (registered design), little effort required due to optimised cutter geometry, induction-hardened cutters provide excellent resistance to wear, special steel, drop-forged, oil hardened



Code	L mm	Head	Handles	Δ g
66 60 1 220	224	polished	black lacquered	318
66 60 1 250	250			390
66 60 1 280	280			434

6661 Pincers

DIN ISO 9243, special steel, drop-forged, oil hardened.



Code	L mm	Head	Handles	Δ g
66 61 1 180	180	polished	black lacquered	322
66 61 1 200	200			350

6662 Heavy Duty steel fixer pincers

DIN ISO 9243, induction-hardened cutting edges, high wear resistance, extremely low cutting force effort due to very large lever effect and optimum cutting edges geometry. Clearly damped cutting shock due to "elastic" pliers body, therefore ideal for continuous use special steel.

Ultra-slim design, ideal for binding recessed reinforcing bars. Special steel, drop-forged, oil hardened.



Code	L mm	Head	Handles	Δ g
66 62 4 300	300	chrome plated, polished	chrome plated	478

6702 Set with 4 pliers, chrome plated

Handles chequered, in plastic inlay

Content:

- 6543** Circlip pliers, J2
- 6544** Circlip pliers, J21
- 6545** Circlip pliers, A2
- 6546** Circlip pliers, A21



Code

△
g

96 65 0004

590

6706 Set with 3 pliers, polished

dip-coated, in plastic inlay

Content:

- 6501** Combination pliers, 180 mm
- 6602** Heavy duty side cutter, 160 mm
- 6529** Snipe nose pliers, 200 mm



Code

△
g

96 65 0008

750

6703 Set with 3 pliers, chrome plated

multi-component handles with softer layers, in plastic inlay

Content:

- 6501** Combination pliers, 180 mm
- 6602** Heavy duty side cutter, 160 mm
- 6529** Snipe nose pliers, 200 mm



Code

△
g

96 65 0005

810

6705 Set with 3 pliers, polished

dip-coated, in plastic inlay

Content:

- 6551** Waterpump pliers, 240 mm, lacquered
- 6501** Combination pliers, 180 mm
- 6602** Heavy duty side cutter, 160 mm



Code

△
g

96 65 0007

880

6704 Set with 3 pliers, chrome plated

multi-component handles with softer layers (No 6501, 6602), in plastic inlay

Content:

- 6551** Waterpump pliers, 240 mm
- 6501** Combination pliers, 180 mm
- 6602** Heavy duty side cutter, 160 mm



Code

△
g

96 65 0006

950

Sets of pliers in plastic inlays also suitable for Workbench No WB620, Tool trolleys No 90, 95, 95VA, 98VA, Magazine case No 920 and Wheely box No 922N (Modular system see page 42-71)

ES 6501-6602/7A



530 x 350 x 40 mm, 7 pieces

Code

△
g

96 83 81 21

2085



No 65 01 5 180



No 65 29 5 200



No 65 43 4 002



No 65 45 4 002



No 65 51 6 240



No 65 64 2 250



No 66 02 5 160

83 81 20 21 Empty tray

307

ES 6501-6602/7B



530 x 350 x 40 mm, 7 pieces

Code

△
g

96 83 81 32

2055



No 65 01 5 200



No 65 29 5 160



No 65 43 4 002



No 65 45 4 002



No 65 51 6 240



No 65 64 2 250



No 66 02 5 160

83 81 20 21 Empty tray

307

Pliers

TCS 6501-6602/3

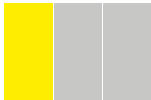

TCS

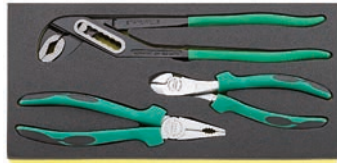

175 x 350 x 40 mm, 3 pieces

Code	g
96 83 87 75	1125



No 65 01 5 200



No 65 51 6 300



No 66 02 5 180

TCS 6501-6602/4

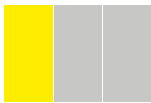

TCS



175 x 350 x 35 mm, 4 pieces

Code	g
96 83 81 79	1000



No 65 01 5 180



No 65 29 5 200



No 65 51 6 240



No 66 02 5 160

TCS 6501-6602/4N



TCS



175 x 350 x 35 mm, 4 pieces

Code	g
96 83 06 22	1080



No 65 01 5 180



No 65 29 5 200



No 65 72 6 240



No 66 02 5 160

TCS 6543-6564/3

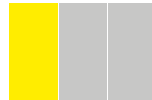

TCS



175 x 350 x 30 mm, 3 pieces

Code	g
96 83 81 80	815



No 65 43 4 002



No 65 45 4 002



No 65 64 2 250

TCS 6543-6546/4



TCS

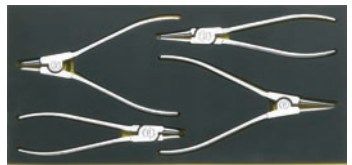

175 x 350 x 30 mm, 4 pieces

Code	g
96 83 06 08	626



No 65 43 4 002



No 65 44 4 021



No 65 45 4 002



No 65 46 4 021

TCS 6534-6545/6



TCS

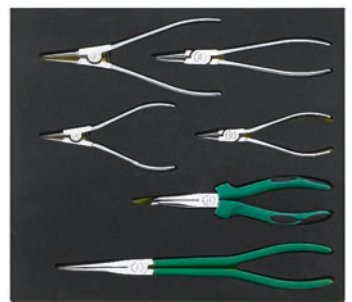

350 x 350 x 30 mm, 6 pieces

Code	g
96 83 21 00	1070



No 65 34 5 280



No 65 35 5 200



No 65 43 4 001

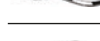

No 65 43 4 002



No 65 45 4 001

No 65 45 4 002

Electronics Pliers, suitable for electrostatic discharge (ESD) applications

6517 Electronics flat nose pliers

DIN ISO 9655, designed for use on miniature electronic and mechanical components, welded on double leaf spring, precision jaws, smooth, tapering, box joint for precise movement.

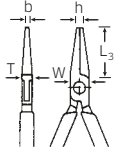

Code	L mm	Head	Handles	L ₃ mm	W mm	T mm	h mm	b mm	Δ g
65 17 6 120	125	polished	dip-coated with sure-grip surface, ESD applications	20	9	6.5	1.5	3	47

6526 Electronics round nose pliers

DIN ISO 9655, designed for use on miniature electronic and mechanical components, welded on double leaf spring, round precision jaws, smooth, thin, box joint for precise movement.

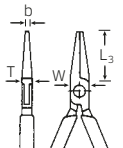

Code	L mm	Head	Handles	L ₃ mm	W mm	T mm	b mm	Δ g
65 26 6 120	125	polished	dip-coated with sure-grip surface, ESD applications	22	9	6.5	1.25	45

6540 Electronics snipe nose pliers

DIN ISO 9655, designed for use on miniature electronic and mechanical components, welded on double leaf spring, half round, smooth precision jaws, tapering, box joint for precise movement.

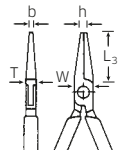

Code	L mm	Head	Handles	L ₃ mm	W mm	T mm	h mm	b mm	Δ g
65 40 6 120	125	polished	dip-coated with sure-grip surface, ESD applications	21	9	6.5	1	1	50

6603 Electronics side cutter

strong, slim pattern, suitable for use on miniature electronic components, precision cutting edges, mini bevel, suitable for soft and hard wire, incl. piano wire, Cu-wire of 0.2 mm \varnothing can be cut at the tips, welded on double leaf spring, alloy steel of highest quality, induction hardened cutting edges approx. 63 HRC.

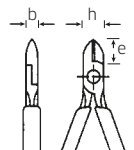

Code	L mm	Head	Handles	e mm	h mm	b mm	①	②	③	④	Δ g
6603 6 115	115	polished	dip-coated with sure-grip surface, ESD applications	14	11	6.5	1.5	1	0.8	0.5	60

① Cutting capacity in mm for soft wire
③ Cutting capacity in mm for hard wire

② Cutting capacity in mm for medium hard wire
④ Cutting capacity in mm for piano wire

6605 Electronics side cutter

DIN ISO 9654, with wire catch to prevent uncontrolled disposal of off-cuts, box joint for precise movement, precision cutting edges, mini bevel, suitable for soft and hard wire, welded on double leaf spring, alloy steel of highest quality, induction hardened cutting edges, approx. 63 HRC.

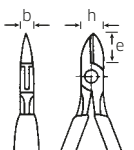

Code	L mm	Head	Handles	e mm	h mm	b mm	①	②	③	④	Δ g
6605 6 110	112	polished	dip-coated with sure-grip surface, ESD applications	13	10.5	7	1.5	1	0.8	0.6	64

① Cutting capacity in mm for soft wire
③ Cutting capacity in mm for hard wire

② Cutting capacity in mm for medium hard wire
④ Cutting capacity in mm for piano wire

Pliers

6606 Electronics side cutters

DIN ISO 9654, strong model, box joint for precise movement, precision cutting edges, mini bevel, suitable for piano wire, Cu-wire 0.25 mm \varnothing can be cut at tips, welded on double leaf spring, alloy steel of highest quality, induction hardened cutting edges, approx. 63 HRC.

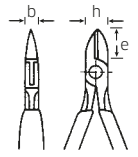

Code	L mm	Head	Handles	e mm	h mm	b mm	①	②	③	④	$\frac{\Delta}{g}$	
6606 6110	112	polished	dip-coated with sure-grip surface, ESD applications	13	12	7.5	1.5	1	0.8	0.6	0.6	64
6606 6130	125			18	16	10	1.7	1.2	1	0.8	104	

① Cutting capacity in mm for soft wire
③ Cutting capacity in mm for hard wire

② Cutting capacity in mm for medium hard wire
④ Cutting capacity in mm for piano wire

6607 Electronics side cutters

DIN ISO 9654, slim tapered head for use in confined spaces, box joint for precise movement, precision cutting edges, no bevel suitable for flush cutting of soft and medium hard wire, Cu- and diode wires, welded on double leaf spring, alloy steel of highest quality, induction hardened cutting edges, approx. 63 HRC.

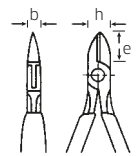

Code	L mm	Head	Handles	e mm	h mm	b mm	①	②	$\frac{\Delta}{g}$
6607 6110	112	polished	dip-coated with sure-grip surface, ESD applications	13	12	7.5	1.5	1	64
6607 6130	125			18	16	10	1.5	1	104

① Cutting capacity in mm for soft wire

② Cutting capacity in mm for medium hard wire

6604 Mini-electronics side cutter

DIN ISO 9654, light, slim pattern, especially suitable for use on miniature electronic components, precision cutting edges, mini bevel, suitable for soft and hard wire, Cu-wire of 0.2 mm \varnothing can be cut at the tips, welded on double leaf spring, alloy steel of highest quality, induction hardened cutting edges, approx. 63 HRC.

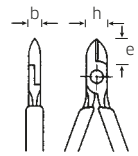

Code	L mm	Head	Handles	e mm	h mm	b mm	①	②	③	④	$\frac{\Delta}{g}$
6604 6110	112	polished	dip-coated with sure-grip surface, ESD applications	11	9	6	1	0.8	0.6	0.4	49

① Cutting capacity in mm for soft wire
③ Cutting capacity in mm for hard wire

② Cutting capacity in mm for medium hard wire
④ Cutting capacity in mm for piano wire

6613 Electronics oblique cutter

DIN ISO 9654, tapered head for use in confined spaces, precision cutting edges for hard and soft wire, head angled by 55°, Cu-wire 0.25 mm \varnothing may be cut at the tips, welded on double leaf spring, alloy steel of highest quality, induction hardened mini-bevelled cutting edges, approx. 62 HRC.

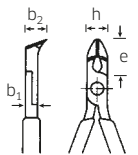

Code	L mm	Head	Handles	e mm	h mm	b ₁ mm	b ₂ mm	①	②	③	④	$\frac{\Delta}{g}$
6613 6115	112	polished	dip-coated with sure-grip surface, ESD applications	11	11	7.5	10.5	1	0.8	0.6	0.4	82

① Cutting capacity in mm for soft wire
③ Cutting capacity in mm for hard wire

② Cutting capacity in mm for medium hard wire
④ Cutting capacity in mm for piano wire

6614 Electronics oblique cutter

DIN ISO 9654, as No 6613, but without bevelled cutting edges, for flush cutting of soft and medium hard Cu- and diode wires.

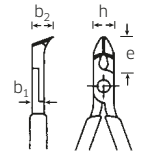

Code	L mm	Head	Handles	e mm	h mm	b ₁ mm	b ₂ mm	①	②	Δ g
6614 6115	112	polished	dip-coated with sure-grip surface, ESD applications	11	11	7.5	10.5	1	0.6	55

① Cutting capacity in mm for soft wire ② Cutting capacity in mm for medium hard wire

6615 Electronics oblique cutter

DIN ISO 9654, slim, extended head for delicate cuts in confined spaces, box joint for precise movement, precision cutting edges with mini bevel for Cu- and diode wires, head angled by 30°, welded on double leaf spring, alloy steel of highest quality.

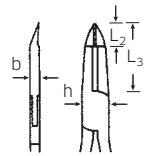

Code	L mm	Head	Handles	L ₂ mm	L ₃ mm	h mm	b mm	①	②	Δ g
6615 6115	112	polished	dip-coated with sure-grip surface, ESD applications	8	18	8	6	0.6	0.3	47

① Cutting capacity in mm for soft wire ② Cutting capacity in mm for medium hard wire

6619 Electronics top cutter

DIN ISO 9654, slim long head for use in confined space, box joint for precise movement, precision cutting edges for Cu- and diode wires, mini-bevel, welded on double leaf spring, alloy steel of highest quality.

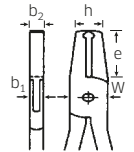

Code	L mm	Head	Handles	e mm	W mm	h mm	b ₁ mm	b ₂ mm	①	②	Δ g
6619 6115	112	polished	dip-coated with sure-grip surface, ESD applications	15.5	8.5	5.5	6	5	0.6	0.3	65

① Cutting capacity in mm for soft wire ② Cutting capacity in mm for medium hard wire

6620 Electronics top cutter

DIN ISO 9654, precision cutting edges for soft and hard wires, mini-bevel, head angled 90°, pointed head, Cu-wire 0.25 mm \varnothing may be cut at the tips, welded on double leaf spring, alloy steel of highest quality, induction hardened cutting edges, approx. 60 HRC.

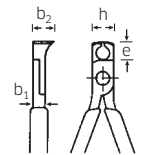

Code	L mm	Head	Handles	e mm	h mm	b ₁ mm	b ₂ mm	①	②	③	④	Δ g
6620 6115	112	polished	dip-coated with sure-grip surface, ESD applications	6.5	11	7.5	11	1	0.8	0.6	0.4	83

① Cutting capacity in mm for soft wire ② Cutting capacity in mm for medium hard wire
③ Cutting capacity in mm for hard wire ④ Cutting capacity in mm for piano wire

6621 Electronics top cutter

DIN ISO 9654, as No 6620, but without bevelled cutting edge, for flush cutting of soft and medium hard Cu- and diode wires, alloy steel of highest quality, induction hardened cutting edges, approx. 60 HRC.

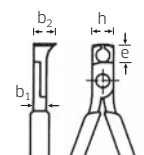

Code	L mm	Head	Handles	e mm	h mm	b ₁ mm	b ₂ mm	①	②	Δ g
6621 6115	112	polished	dip-coated with sure-grip surface, ESD applications	6.5	11	7.5	11	1	0.6	84

① Cutting capacity in mm for soft wire ② Cutting capacity in mm for medium hard wire



8 | PIPE TOOLS, MISCELLANEOUS TOOLS

PIPE TOOLS
→ PAGE 280



HAMMERS
→ PAGE 282



CHISELS, DRIFT PINS, CENTRE PUNCHES, PIN PUNCHES
→ PAGE 283



SCRAPERS, FILES, HACKSAWS
→ PAGE 286



THREAD TOOLS
→ PAGE 288



**SCREW EXTRACTOR, STUD REMOVER,
NUT SPLITTERS**
→ PAGE 289



MEASURING TOOLS
→ PAGE 289



RATCHET TAP HOLDERS
→ PAGE 290



MISCELLANEOUS TOOLS
→ PAGE 290



TORCHES
→ PAGE 293



TWEEZERS, WIRE CUTTER
→ PAGE 294





Original STAHLWILLE pipe and tube tools

These extremely robust pipe cutters guarantee accurate cutting without the danger of the cut running off at an angle. Pipes can be directly passed on to the next processing stage.

EXPRESS Pipe Cutter No 150

Ideal for pipes made of steel, copper, brass, light alloy and hard plastics. This tool is available in two sizes to cover outer diameters from 6 to 63 mm.

Essential product advantages when cutting pipes with STAHLWILLE pipe cutters:

Straight-line cutting

STAHLWILLE EXPRESS pipe cutters ensure a perfectly perpendicular cut. The broad support rolls ensure that the cutting wheels are accurately guided throughout the cut. In this way, the cut cannot run off at an angle on the pipe surface or enter the pipe at a tilted angle. The robust drop forged upper-jaw section with its reinforced cutter-wheel guides prevents spiral cuts.

Deburring and chamfering

The wide guide rolls flatten the burr created during the cutting process back into the material. Separate deburring is not required. The cut-to-length pipe is automatically chamfered and can be passed directly to the next processing step. The cut edge is angled in accordance with the cutting wheel geometry.

Universally applicable - Work on pipes in situ

STAHLWILLE EXPRESS pipe cutters can also be equipped with three cutting wheels. This enables extremely efficient work on pipes in situ involving only a small angle of movement.



1

Pin for wheels and rolls



2

Cutting wheels for steel, non-ferrous metal and plastic pipes



3

Guide rolls for pipe cutters



4

Additional rings for versions with three cutting wheels

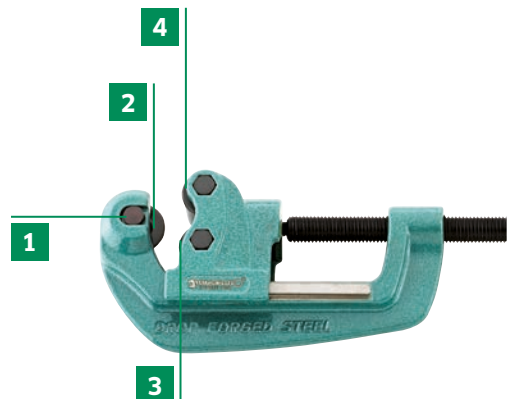

METAL Pipe Cutter No 153

This light-weight, extremely convenient tool is specially suitable for cutting tubes made of copper, brass, light alloy or hard plastics and for thin-walled steel tubes with outer diameters of from 3 to 35 mm and maximum cutting depths of 2.5 mm. The integrated internal three-bladed cutter in the handle removes burrs.



Midget tube cutter No 155

For pipes and tubes made of copper, brass, light alloy, hard plastics and for thin-walled steel tubes with outer diameters of from 3 to 16 mm where the maximum cutting depth is 2.0 mm - we recommend this extremely compact and accurate tube cutter.



Chain Pipe Cutter No 157

Special pipe cutter, infinitely variable, with rotating handle, also for cutting stainless steel pipes with wall thicknesses of up to 1.8 mm and outer diameters of from 25 to 75 mm. Chain lengths up to 270 mm.



STAHLWILLE cutting wheels for steel pipes

Especially high-grade, wear-resistant steel enables extraordinarily high cutting force. The cutting wheels are made of very tough special steel which guarantees long service lifetimes.

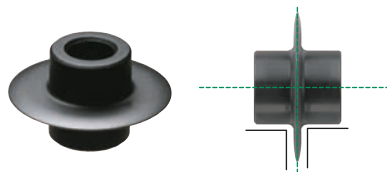

STAHLWILLE Double Flaring Tools No 165N

Double Flaring Tools are used for making permanent connections between pressurised pipes. DIN standard double flares in accordance with DIN 74234 can be made with this convenient easy-to-use and tough tool made by STAHLWILLE to create safe connections (e.g. in car brake leads) without the need for special skills. Simply clamp the tool in the vice - and it is ready for use. This tool guarantees rapid, safe processing of seamless drawn and double-walled rolled pipes (Bundy®) with wall thicknesses of 0.7 or 1.0 mm with a single flaring bit.



STAHLWILLE flaring tools - simple to use and guaranteed optimum results.

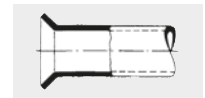

Single flaring cone D

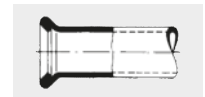

Double flaring cone E

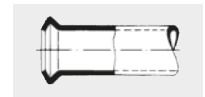

Double flaring cone F

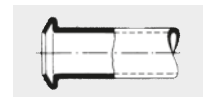

Double flaring cone F 180°

Various DIN standard single and double flares - easily and quickly produced using the STAHLWILLE double flaring tool.

Pipe cutters, Miscellaneous tools

150 EXPRESS pipe cutters

with one cutting wheel and two guide rollers; for steel, copper, brass, aluminium and hard plastic tubes.



Code	size	1/8"	mm	mm	Cutting depth max. mm	g	g	g
60021001	1¹⁾	1/8-1 1/4	3-32	6-43	4.5	1220	1	
60021002	2¹⁾	1/8-2	3-50	10-63	7	2149	1	
60121001	1/3²⁾	1/8-1 1/4	3-32	6-43	4.5	1113	1	
60121002	2/3²⁾	1/8-2	3-50	10-63	7	1975	1	

¹⁾ with wide guide rollers

²⁾ with three cutting wheels

153 METAL pipe cutter

for use on copper, brass, light alloy, PVC and thin walled steel tubes, with deburring tool (3 cutting edges) inside handle, forged, chrome plated.



Code	1/8"	mm	Cutting depth max. mm	g	g
60010000	1/8-1 3/8	3-35	2.5	356	1

155 Small bore pipe cutter

for use on copper, brass, light alloy, PVC and thin walled steel tubes.



Code	1/8"	mm	Cutting depth max. mm	g	g
60070001	1/8-5/8	3-16	2	102	1

SR150 Cutting wheels

for steel pipes.

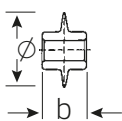

Code	size	for pipe cutter	ø mm	b mm	g	g
69020101	1	150/1	25	14	14	10
69020201	2	150/2	32	19	28	10
69020301	3/4	150/3 + 4	41	19	38	10

SR153 Cutting wheels



Code	for pipe cutter	ø mm	b mm	g	g
69010001	153	20	6	6	10

SR155 Cutting wheels

Code	for pipe cutter	ø mm	b mm	g	g
69110001	155	20	5	5	10

157 Chain pipe cutter

infinitely adjustable, with twist handle, also suitable for special steel pipes up to 1.8 mm wall thickness, chain length 270 mm.



Code	mm	Cutting depth max. mm	g	g
60110001	25-75	2	705	1

K157 Chain

Code	g	g
69130001	183	1

RL 150/153/1500 Guide rollers

for pipe cutters.



Code	No	for pipe cutter	ø mm	b mm	g	g
69020107	RL 1500/1	150/1	23	21.5	62	2
69070202	RL 1500/2	150-151/2	28	27.5	117	5
69020302	RL 150/3/4	150-151/3 + 4	33	19	115	5
69010002	RL 153	153	12	12	10	5

BL/BZ 150/153/1500 Spindles

for wheels and guide rollers.



Code	No	wheelbolt	rollerbolt	for pipe cutter	L mm	ø mm	g	g
69020104	BL 150/1	x ¹⁾		150/1	29	7.5	10	1
69020103	BZ 1500/1		x ²⁾	150/1	38.5	7.5	14	10
69070203	BZ 1500/2		x	150-151/2	46	9	23	10
69070204	BL 1500/2	x		150-151/2	38	9	19	10
69020303	BZ 150/3/4	x	x	150-151/3 + 4	36	9	17	10
69020304	BL 150/4N	x ³⁾		150/4	40	9	20	1
69010003	BZ 153		x	153	18.5	4	2	10
69010004	BL 153	x		153	13	4.75	2	1

BL = wheel bolt

BZ = roller bolt

¹⁾ wheel- and roller bolt for 150/1 until 1985. wheel bolt for 150/1 from 1986

²⁾ roller bolt for 150/1 from 1986

³⁾ wheel bolt for 150/4 from 2009

RI 1500 Spacing washers

When required to fit pipe cutters No 150/1, 150/2 or No 150/4 with 3 cutting wheels (to work in confined spaces), a total of 4 spacing washers is required.

Simply exchange the 2 guide rollers for 2 cutting wheels No SR150 with 2 spacing washers to each.



Code	size	for pipe cutter	ø mm	b mm	g	g
68020101	1	150/1	14	3.9	8	6
68020201	2	150/2. 151/2	16	4.45	4	6
68020301	4	150/4 *)	18	9.5	18	1

*) For 150/4 from 2009

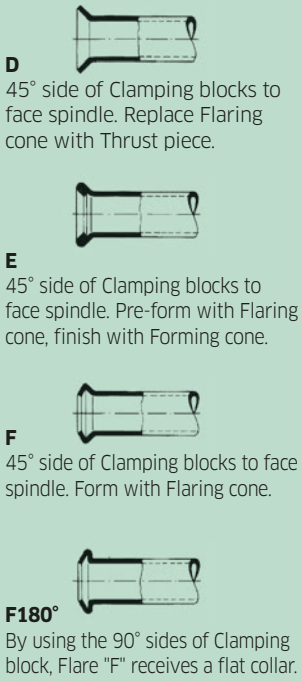

Double flaring tool

This simple-to-use STAHLWILLE Double Flaring tool will form accurate flares (to DIN 74234) on seamless drawn- and double walled (BUNDY®) tubes.

Clamped in a vice, the tool is instantly ready for use. Flaring and Pressure Cones are quickly changed.

The robust construction of the tool, plus the shape of Flaring cones, enables single cone flaring on tubes of 0.7 or 1.0 mm wall thickness.

Tubing is held horizontally by 25 mm wide Clamping blocks. This is important when endless tubing is used. A distance pin controls length of tube required for flaring.

1650N Clamping blocks

1 pair



Code	mm	g	g	g
6803 1001	4.75; 5; 6; 8; 9; 10 mm; 3/16; 1/4; 5/16; 3/8"	198	1	

1650K Clamping blocks

1 pair, for dip-coated brake leads.



Code	mm	g	g	g
6803 0003	5; 6 mm	234	1	

1651 Flaring cones



Code	size	mm	g	g
6804 0708	6+8 mm+1/4+5/16"	8	56	1
6804 0910	9+10 mm+3/8"	10	56	1

1652N Thrust piece/flaring cone

45°; 4.75/5 mm+3/16", for Double flaring tool No 165N.



Code	mm	g	g	g
6805 1001	4.75/5 mm + 3/16"	55	1	

1655N Flaring spindle

for Double flaring tool No 165N.



Code	g	g	g
69 10 1002	54	1	

1656N Clamping screw

for Double flaring tool No 165N.



Code	g	g	g
69 10 1003	102	1	

165N Double flaring tool

with
1 pair of Clamping blocks No 1650N,
2 Flaring cones No 1651 and
1 Thrust piece/flaring cone No 1652N.



Code	mm	g	g	g
6303 1000	4.75; 5; 6; 8; 9; 10 mm; 3/16; 1/4; 5/16; 3/8"	1420	1	



Pipe cutters, Miscellaneous tools

10940 Rubber composition hammers

DIN 5128, with two plane faces.

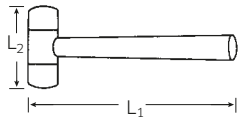

Code	∅ mm	L ₁ mm	L ₂ mm	⚖ g	📦
70 14 00 01	55	320	90	317	2
70 14 00 02	65	350	115	527	2
70 14 00 03	75	350	130	780	2
70 14 00 04	90	380	140	1193	2

10955 Plastic hammers

with interchangeable heads of impact resisting cellulose acetate and ash handles.



Code	∅ mm	L ₁ mm	L ₂ mm	⚖ g	📦
70 16 00 27	27	265	90	225	6
70 16 00 32	32	280	100	320	6
70 16 00 35	35	290	105	376	2
70 16 00 40	40	320	110	545	2
70 16 00 50	50	340	115	873	2

10955R Spare plastic heads

of impact resisting cellulose acetate, these are lightly heated and then tapped into position.

Code	∅ mm	⚖ g	📦
79 04 00 27	27	14	5
79 04 00 32	32	22	10
79 04 00 35	35	29	10
79 04 00 40	40	39	10
79 04 00 50	50	69	10

10956 Nylon hammers

with interchangeable heads of shockproof nylon vestamid and hickory handles.



Code	∅ mm	L ₁ mm	L ₂ mm	⚖ g	📦
70 17 10 27	27	265	90	232	6
70 17 10 32	32	280	100	336	6
70 17 10 35	35	290	105	413	2
70 17 10 40	40	320	110	546	2
70 17 10 50	50	340	115	898	2
70 17 10 60	60	380	135	1339	2

10956R Spare nylon heads

these are lightly heated and then tapped into position.

Code	∅ mm	⚖ g	📦
79 05 00 27	27	11	10
79 05 00 32	32	18	10
79 05 00 35	35	23	10
79 05 00 40	40	31	10
79 05 00 50	50	53	10
79 05 00 60	60	83	10

10957 Plastic hammers

the hollow head is partially filled with steel shot which adds to the weight, prevents recoil; with interchangeable heads made of medium-hard polyurethane and with a hickory handle.



Code	∅ mm	L ₁ mm	L ₂ mm	⚖ g	📦
70 19 00 25	25	320	108	320	6
70 19 00 30	30	350	115	460	6
70 19 00 35	35	355	118	580	6
70 19 00 40	40	375	125	760	2
70 19 00 50	50	385	135	1250	2
70 19 00 60	60	420	165	1900	2

10957R Spare plastic heads

Code	∅ mm	⚖ g	📦
79 09 00 25	25	14	10
79 09 00 30	30	19	10
79 09 00 35	35	26	10
79 09 00 40	40	38	10
79 09 00 50	50	72	10
79 09 00 60	60	118	10

10958 Embossing hammer

aluminium, cylindrical, with hickory handle.



Code	∅ mm	L ₁ mm	L ₂ mm	⚖ g	📦
70 24 00 40	40	340	155	648	2

10960 Engineers hammers

with ash handles, DIN 1041.

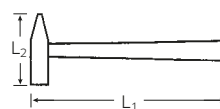

Code	g	L ₁ mm	L ₂ mm	⚖ g	📦
70 11 00 05	100	260	82	148	6
70 11 00 01	200	280	95	254	6
70 11 00 04	300	300	105	400	6
70 11 00 02	500	320	118	600	6
70 11 00 06	800	350	130	951	2
70 11 00 03	1000	360	135	1132	2
70 11 00 07	1500	380	145	1617	2
70 11 00 08	2000	400	155	2285	2

 Made in Germany

10970 Engineers hammers

with ash handles.



Code	lb.	L ₁ mm	L ₂ mm	⚖ g	📦
70 12 0001	1/4	270	67	176	6
70 12 0005	1/2	290	82	320	6
70 12 0006	3/4	310	93	454	6
70 12 0002	1	320	99	572	6
70 12 0004	1 1/2	350	118	790	2
70 12 0003	2	380	126	1044	2

ES 10956/10960/2



175 x 350 x 45 mm, 2 pieces

Code	⚖ g
96 83 81 25	1130



No 10956

∅ 35 mm



No 10960

500 g

83 81 20 25	Empty tray	114
-------------	------------	-----

ES 10956/10970/2



175 x 350 x 45 mm, 2 pieces

Code	⚖ g
96 83 81 31	1075



No 10956

∅ 35 mm



No 10970

1 lb.

83 81 20 25	Empty tray	114
-------------	------------	-----

100 Ribbed cold chisels

of tough tempered special steel, chrome plated.



Code	size	L mm	b mm	⚖ g	📦
70 01 0006	6	150	20	165	10
70 01 0008	8	200	26	305	5
70 01 0010	10	250	30	507	5
70 01 0012	12	300	35	807	5

102 Cold chisels

DIN 6453, chrome vanadium steel, lacquered silver.



Code	size	L mm	b mm	⚖ g	📦
70 02 0002	125	125	15	96	10
70 02 0003	150	150	18	172	10
70 02 0004	175	175	21	269	10
70 02 0005	200	200	24	379	5
70 02 0007	250	250	25	479	5
70 02 0008	300	300	26	591	5

103 Cross-cut chisels

DIN 6451, flat, chrome vanadium steel, lacquered silver.



Code	size	L mm	b mm	⚖ g	📦
70 04 0003	150	150	16	147	10
70 04 0004	175	175	17	239	10
70 04 0005	200	200	18	340	5

110 Grooving chisel

flat, chrome vanadium steel, lacquered silver.



Code	L mm	b mm	⚖ g	📦
70 08 0001	240	26	298	5

112 Grooving chisel

as No 110, but with finger protector.



Code	L mm	b mm	⚖ g	📦
70 08 0002	240	26	434	5

112/1 Finger protector

for Cold Chisels No 102 and Cross-cut chisels No 103 from 200 mm onward, for Grooving chisel No 110, shaft section 23 x 13 mm.

Code	⚖ g	📦
79 16 0001	101	5

Pipe cutters, Miscellaneous tools

104 Drift pins

DIN 6458, octagonal, chrome vanadium, lacquered silver.



Code	size	● mm	● mm	L mm	⚖ g	📦
70060007	120 x 2	2	10	120	60	10
70060010	120 x 3	3	10	120	60	10
70060002	120 x 4	4	10	120	62	10
70060008	120 x 5	5	10	120	64	10
70060003	120 x 6	6	10	120	66	10
70060009	120 x 8	8	12	120	68	10

105 Centre punches

DIN 7250, octagonal, chrome vanadium, lacquered silver.



Code	size	● mm	L mm	⚖ g	📦
70050001	100 x 10	10	100	52	10
70050005	120 x 10	10	120	63	10
70050002	120 x 12	12	120	90	10

108 Parallel pin punches

DIN 6450, octagonal, chrome vanadium, lacquered silver.



Code	size	● mm	● mm	L mm	⚖ g	📦
70071152	115 x 2	2	8	115	29	10
70070013	125 x 3	3	8	125	35	10
70070001	150 x 2.5	2.5	10	150	65	10
70070002	150 x 3	3	10	150	62	10
70070003	150 x 4	4	10	150	64	10
70070004	150 x 5	5	10	150	67	10
70070005	150 x 6	6	10	150	72	10
70070006	150 x 8	8	10	150	81	10
70070009	175 x 3	3	10	175	57	10
70070010	175 x 4 ¹⁾	4	10	175	64	10
70070012	175 x 6	6	10	175	69	10
70070008	200 x 8	8	12	200	141	10
70070011	200 x 10	10	12	200	159	10

¹⁾ for use on Mercedes-Benz (retaining pins of disc brake pads)

- diameter of tip
- size of handle, octagon

109 Pin punches

with guide bush.



Code	size	● mm	● mm	L mm	⚖ g	📦
70090001	1	0.9	5	80	7	10
70090002	2	1.4	5.5	82	12	10
70090003	3	1.8	6	86	12	10
70090004	4	2.4	7	95	18	10
70090005	5	2.8	7	97	19	10
70090006	6	3.4	8	100	25	10
70090007	7	3.9	9	100	27	10
70090008	8*	5.9	10	103	47	10

- diameter of tip
- diameter of handle
- * without guide bush

ES 102/108/109/4



175 x 350 x 30 mm, 4 pieces

Code	⚖ g
96838123	555
No 102	175 mm
No 108	150 x 6; 175 x 6 mm
No 109	size 6; 100 x 3.4 mm
83812027	Empty tray 115

ES 102/105/108/8



175 x 350 x 33 mm, 8 pieces

Code	⚖ g
96838124	900
No 102	175 mm
No 105	120 x 12 mm
No 108	150 x 2.5; 150 x 3; 150 x 4; 150 x 5; 150 x 6; 150 x 8 mm
83812036	Empty tray 114

102-5/6 Sets: Chisels, pins, punches

6 pieces
 content: 1 each
 No 106/125 mm
 No 106/150 mm
 No 107/125 mm
 No 104/120 x 2;
 120 x 4 mm
 No 105/120 x 10 mm
 D = in plastic stand
 T = in textile bag



Code	No	⚖ g	📦
98812201	102-5/6 D	445	1
98812202	102-5/6 T	426	5

104-5/6D Set: Drift pins, centre punches

6 pieces
 Content: 1 each
 No 104/120 x 2; 120 x 3; 120 x 4;
 120 x 5; 120 x 6 mm
 No 105/120 x 10 mm
 in plastic stand



Code	⚖ g	📦
96700601	417	1

105-8/6K Pin punch-/centre punch set

6 pieces
in transparent plastic container
stand.

Content: 1 each
No 108/150 x 2.5; 150 x 3;
150 x 4; 150 x 5; 150 x 6 mm;
DIN 6450/ Form C
No 105/120 x 10 mm;
DIN 7250



Code	g	g	g
96 70 07 11	483	1	

108/6 Sets: Parallel pin punches

6 pieces
Content: 1 each
No 108/150 x 2.5; 150 x 3;
150 x 4; 150 x 5; 150 x 6;
150 x 8 mm
D = in plastic stand
T = in textile bag



Code	No	g	g
96 70 07 01	108/6 D	450	1
96 70 07 02	108/6 T	424	5

TCS 102-109/10956/10960/6

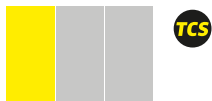

175 x 350 x 40 mm, 6 pieces



Code	g	g
96 83 81 81	1500	

No 10956	Ø 35 mm
No 10960	500 g
No 102	175 mm
No 108	150 x 6; 175 x 6 mm
No 109	size 6; 100 x 3.4 mm

TCS 102-108/11



175 x 350 x 33 mm, 11 pieces



Code	g	g
96 83 87 54	1665	

No 102	150; 200; 250 mm
No 105	120 x 10; 120 x 12 mm
No 108	150 x 2.5; 150 x 3; 150 x 4; 150 x 5; 150 x 6; 150 x 8 mm

TCS 102-108/10957/10960 MF



530 x 350 x 40 mm, 12 pieces



Code	g	g
96 83 03 55	3343	

No 102	200 mm
No 103	150 mm
No 105	120 x 10 mm
No 108	150 x 3; 150 x 4; 150 x 5; 150 x 6; 150 x 8 mm
No 10957	Ø 40 mm
No 10960	500; 800 g
No 12718	

TCS 102-108/10957/12718/13



530 x 350 x 40 mm, 13 pieces



Code	g	g
96 83 02 26	3730	

No 102	200 mm
No 103	150 mm
No 105	120 x 10 mm
No 108	150 x 3; 150 x 4; 150 x 5; 150 x 6; 150 x 8; 200 x 8 mm
No 10957	Ø 40 mm
No 10960	500; 800 g
No 12718	

TCS 102-108/10960/10

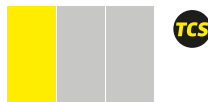

175 x 350 x 40 mm, 10 pieces



Code	g	g
96 83 03 61	1569	

No 102	200 mm
No 105	120 x 12 mm
No 108	115 x 2; 150 x 3; 150 x 4; 150 x 5; 150 x 6; 175 x 4; 200 x 8 mm
No 10960	500 g

Pipe cutters, Miscellaneous tools

TCS 102-108/10957/10960/13



TCS



530 x 350 x 60 mm, 13 pieces

Code		△△ g
96830177		5540
No 102	200; 300 mm	
No 103	175 mm	
No 105	120 x 12 mm	
No 108	150 x 3; 150 x 4; 150 x 5; 150 x 6; 150 x 8 mm	
No 10957	∅ 50 mm	
No 10960	500; 800; 1000 g	

TCS 102-108/10957/10960/16



TCS



530 x 350 x 45 mm, 16 pieces

Code		△△ g
96830609		3715
No 102	200 mm	
No 103	150 mm	
No 105	120 x 10 mm	
No 108	150 x 3; 150 x 4; 150 x 5; 150 x 6; 150 x 8 mm	
No 10957	∅ 40 mm	
No 10960	500 g	
No 12373		
No 12600	500 g	
No 12718		
No 12935/3	3 m	
No 65 64 2 250		
No 39 Pkw	400 mm	

TCS 102-108/10956/10960/18



TCS



530 x 350 x 55 mm, 18 pieces

Code		△△ g
96830620		3653
No 102	150 mm	
No 103	150 mm	
No 105	120 x 10 mm	
No 108	150 x 2.5; 150 x 3; 150 x 4; 150 x 5; 150 x 6; 150 x 8 mm	
No 10956	∅ 50 mm	
No 10960	300; 500 g	
No 10356		
No 10670	285 mm	
No 10672	20 x 315 mm	
No 12374		
No 12900N		
No 12965N		

10669 Fine scraper

- three-sided hollow-profile scraper with black plastic protective cap
- black plastic handle



Code	L mm	Blade mm	△△ g	☐
72060100	147	25 x 8	28	1

10670 Three square engineers scrapers

special steel.



Code	L mm	△△ g	☐
72063101	210	106	5
72063103	260	124	5
72063104	285	140	5
72063105	310	152	5

10672 Flat engineers scrapers

special steel.



Code	mm	△△ g	☐
72053104	20 x 315	227	5
72053105	25 x 365	367	5

10676 Three square engineers bearing scraper

special steel.



Code	mm	△△ g	☐
72083103	85 x 12 x 315	160	5

Made in Germany

12025 Engineers file, round

DIN 8349, cut 2



Code	L mm	g	
72 12 31 00	210	118	5

12030 Engineers file, half round

DIN 8349, cut 2



Code	L mm	g	
72 13 31 00	260	317	5

12035 Engineers file, three-square

DIN 8349, cut 2



Code	L mm	g	
72 14 31 00	210	201	5

12036 Engineers file, hand

DIN 8349, cut 2



Code	L mm	g	
72 17 31 02	260	339	5

12800 Set warding files

6 pieces, in textile bag, DIN 7283,
Content:
1 file each, hand, flat, half round,
three square, square, round.



Code	L mm	g	
72 23 00 01	100	111	5

13100 Set of needle files

6 pieces, in textile bag,
Content:
1 file each, round, half round,
three square, square, hand, flat.



Code	L mm	g	
96 72 28 01	140	50	1

12200 Hand vice

forged C 35,
width of jaws 48 mm.



Code	L mm	g	
71 20 00 00	145	673	1

12050 Tubular hacksaw

with blade size 300 mm/12".



Code	L mm	g	
72 21 00 00	465	490	1

12050R Spare hacksaw blades for No 12050

10 pieces, H.S. Steel, 24 teeth per inch.

Code	L mm	g	
79 18 00 01	300	174	1

12053 Hacksaw frame



Code	L mm	g	
72 21 00 02	252	159	1

12053R Spare hacksaw blades for No 12053

6 pieces, Chrome Alloy Tool Steel, 32 teeth per inch.

Code	L mm	g	
79 18 00 02	158	23	1

ES 10670-13110/11



530 x 350 x 35 mm, 11 pieces

Code	g
96 83 81 73	2120

No 10670	265 mm
No 12025	210 mm
No 12030	260 mm
No 12035	210 mm
No 12036	260 mm
No 12050	465 mm
No 12320	
No 12321	
No 12377	
No 12935/3	3 m
No 13110	300 mm
83 81 20 88 Empty tray	301

Pipe cutters, Miscellaneous tools

TCS 10356-12965/5

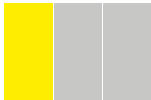

TCS



175 x 350 x 40 mm, 5 pieces

Code	△△ g
96 83 87 90	595

	No 12053	158 mm
	No 10356	40 mm
	No 10356R	10 Stück
	No 12320	
	No 12965	

TCS 11095-13110/8

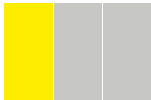

TCS



175 x 350 x 40 mm, 8 pieces

Code	△△ g
96 83 87 89	700

	No 12000	ISO
	No 11095/20	0.05 - 1.00 mm
	No 12935/3	3 m
	No 12321	
	No 12322	
	No 12665/52	0.25 - 6 mm
	No 12900	
	No 13110	300 mm

12000 Universal thread restorers

suitable for inside and outside threads.



Code	size	L mm	△△ g	☐
72 10 0004	ISO	230	119	10
72 10 0003	SAE	230	118	10
72 10 0002	WW	230	122	10

Pitch mm	---- ISO ----		---- Ww ----		SAE/US threads per inch
	metr. thread	threads per inch	Whitworth thread		
0.80	5	24	3/16 + 7/32	24	
1.00	6 + 7	20	1/4	20	
1.25	8 + 9	18	5/16	18	
1.50	10 + 11	16	3/8	16	
1.75	12	14	7/16	14	
2.00	14 + 16	12	1/2 + 9/16	13	
2.50	18, 20, 22	11	5/8 + 11/16	12	
3.00	24 + 27	10	3/4 + 13/16	11	

TCS 12025-13110/11



TCS



530 x 350 x 35 mm, 11 pieces

Code	△△ g
96 83 87 59	2070

	No 12025	210 mm
	No 12030	260 mm
	No 12035	210 mm
	No 12036	260 mm
	No 12050	300 mm
	No 12320	
	No 12321	
	No 12718	
	No 12935/3	3 m
	No 12965N	
	No 13110	300 mm

905/25 Stud remover set

M 5-M 16, 3/16"-5/8", 25 pieces, in green plastic box.

Content:

- 5 HSS twist drills sizes (3.2; 4.8; 6.4; 8; 8.7 mm)
- 5 Fluted Removal Pins sizes 1-5 for threads M5-M16
- 5 Splined Nuts, sizes 1-5
- 10 Drill Guides, sizes 1-10



Code	△△ g	☐
96 71 30 25	555	1

906 Spare parts

Removal pins and splined nuts, in pairs in plastic bags.

Code	size	for threads	△△ g	☐
71 31 0001	1	M5-M6 3/16-1/4"	14	1
71 31 0002	2	M7-M8 1/4-5/16"	20	1
71 31 0003	3	M10 3/8"	33	1
71 31 0004	4	M12 7/16"	46	1
71 31 0005	5	M14-M16 1/2-9/16"	645	1

900/6T Screw EXTRACTOR set

in textile bag.



Code	Content		
96 71 01 01	1 each No 900 size 1-6	190	5

900 Screw EXTRACTOR



Code	size	for bolts	■ mm	■"	L mm	recommend. Drill		
71 01 00 01	1	M3-M4	3	1/8	49	2 mm 5/64"	3	10
71 01 00 02	2	M5-M7	3.4	9/64	54	3 mm 7/64"	6	10
71 01 00 03	3	M8	4.9	3/16	59	5 mm 3/16"	12	10
71 01 00 04	4	M10-M12	7	9/32	65	6.4 mm 1/4"	25	5
71 01 00 05	5	M14-M16	9	23/64	88	8 mm 5/16"	50	5
71 01 00 06	6	M18-M22	12	31/64	95	12 mm 15/32"	103	5

901/5T Set of screw extractors

for extracting sheared screws, bolts & stud screws from threaded holes, suitable for right-hand and left-hand threads, in textile bag



Code	size		
96 71 05 05	1-5	246	1

901 Screw EXTRACTOR

with centre punch tip, double-edged.



Code	size	for bolts	■ mm	■"	L mm	recommend Drill		
71 05 00 01	1	M5-M6	6.35	1/4	60	3.2 mm 1/8"	6	10
71 05 00 02	2	M8-M10	9.5	3/8	67	4.8 mm 3/16"	16	10
71 05 00 03	3	M10-M12	12.7	1/2	75	6.4 mm 1/4"	30	10
71 05 00 04	4	M12-M16	15.9	5/8	90	9.5 mm 3/8"	60	10
71 05 00 05	5	M16-M20	19	3/4	90	11.1 mm 7/16"	100	10

904 Stud remover

- Suitable for all sizes of studs from 6-12 mm.
- Also suitable for percussion screwdriver use.
- Will cope with rusted or scale-coated screws with a minimum of 3 mm protruding. Chuck: size 36 mm
Clamping screw: size 24 mm



Code			
71 34 00 00	3/8	346	1

12615 Nut splitters

zinc plated, mechanical, for splitting seized or overtightened nuts up to class 8.

Does not damage the threaded pin. As the spindle is tightened, the nutsplitter body has to be locked with an open-jaw spanner to prevent it turning. Cutting chisel made of high-grade alloy tool steel.



Code	size	for nuts SW mm	Max. torque N·m		
71 25 00 11	1	10-18	40	193	1
71 25 00 12	2	19-27	60	386	1

12665 Screw pitch gauge

0.25 to 6 mm and 4 to 62 t.p.i. (metric/Whitworth threads).



Code	size		
77 27 00 03	52	79	10

12900N Vernier calliper

as per DIN 862, vernier readings 1/20 mm and 1/128", stainless steel, in plastic pouch.



Code	measuring range mm/"		
77 37 10 01	150/6	185	1

12900/1N Vernier calliper

- with metal housing cover and metal buttons
- with data output (mini USB)
- mechanical system made of stainless, hardened steel
- with or without thumb wheel (included in delivery for customer to fit if required)
- large LCD display with clear read-offs, figures 9 mm high
- display accuracy 0.01 mm/ 0.0005"
- measuring tips ground fine and lapped
- ON/OFF button
- with depth gauge
- unit of measure in mm or imperial, zeroing possible at any position
- incl. 2 x 3 V battery (Type CR2032) packaged in accordance with UN 3091, Class 9
- in plastic case



Code	measuring range mm/"		
77 37 10 02	150/6	312	1

Pipe cutters, Miscellaneous tools

12900/3 Tyre tread Vernier calliper

- sturdy brass construction
- smooth ground surface



Code	measuring range mm		
77 37 1004	30	41	1

12900/4 Electronic tyre tread Vernier calliper

- large LCD display with clear read-offs, figures 9.5 mm high
- display accuracy 0.01 mm/0.0005"
- ON/OFF push button
- unit of measure switchable mm/inch
- zeroing possible in any position
- incl. 1 x 3 V battery (Type CR2032) packaged in accordance with UN 3091, Class 9



Code	measuring range mm/"		
77 37 1005	25/1	64	1

12935 Tape measure

with tape lock. Metric-Inch scales.

NEW



Code	size	L m		
77 04 00 10	3	3	92	10
77 04 00 11	5	5	164	10

13110 Steel rule

Metric-Inch scales, length 300 mm.



Code	Divisions Top Edge "	Divisions Lower Edge mm		
77 46 00 01	1/16, 1/32, 1/64	0.5; 1	26	5

12915 Ratchet tap holders

steel, chrome plated.



Code	size	Capacity mm	DIN ¹⁾	ISO ²⁾	L mm		
77 39 00 01	1	2.0-5.0	M3-8	M1-6	85	180	1
77 39 00 02	2	4.6-8	M5-12	M6-12	110	305	1

¹⁾ for taps DIN

²⁾ for taps ISO

12932 Padlock



Code		
77 21 00 02	85	1

12250 Force feed oil can

metal container, brass pump.
Content:
500 ccm



Code		
77 01 00 01	270	1

12251 Plastic oil can

made of plastic.
Content:
250 ccm



Code		
77 11 00 02	80	5

12320 Electricians cable knife

with stainless blade.



Code	Blade mm		
77 02 00 00	90	81	10

12321 Scribing iron

with knurled centre-section.
1 straight and 1 offset blade;
blades gunmetal finished.



Code	L mm		
77 10 00 00	250	31	10

12322 Tungsten carbide scribing iron

straight type; sturdy shank with tungsten carbide tip. Can be reground. Holder and clip.



Code	L mm	g	
77 10 0001	150	40	10

12374 Wire brush

wood, steel wire dia. 0.35 mm.



Code	L mm	Rows	g	
77 09 0000	290	4	129	10

12377 Wire brush

with brass coated steel bristles.



Code	L mm	g	
77 09 00 10	270	140	24

12378 File brush



Code	L mm	g	
77 25 0000	260	74	5

13115 Brass wire brush

for use on light alloys.



Code	L mm	Rows	g	
77 47 0001	280	4	134	1

12481 Scraper



Code	L mm	b mm	g	
77 07 0000	212	60	65	10

12600 Magnetic lifters

Loss of adhesion above 80°C.

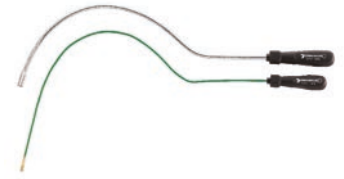

Code	lifting power g	∅ mm	L mm	g	
77 26 00 27	270 ¹⁾	5	500	30	1
77 26 00 25	500	8	460	70	1
77 26 00 60	1800	15	525	232	1
77 26 02 00	3000	19	535	297	1

¹⁾ Miniature magnetic lifter with tiny head, very powerful

12910 Adjustable hook spanners

for slotted nuts as per DIN 1810, adjustable.



Code	size	∅ mm	g	
44 01 00 01	1	20-42	90	5
44 01 00 02	2	45-90	245	5
44 01 00 03	3	95-165	686	5

12921M Telescopic stainless steel mirror

FOD

- Unbreakable mirrors made of stainless steel (FOD)
- No bolted joints (FOD)
- Rust-proof stainless steel telescopic arm
- Universal joint (180° action), self-tensioning
- Special plastic handle ensures a firm grip and safe working, resistant to chemicals



Code	size	mm	L mm	g	
77 40 10 32	1 1/4"/32 mm	∅ 32	171-699	56	1
77 40 10 45	1 3/4" x 2 3/4"/45 x 70 mm	□ 45 x 70	178-927	76	1
77 40 10 57	2 1/4"/57 mm	∅ 57	178-921	70	1

12920N Telescopic mirror

with non-twisting, oval-section telescopic rod.



Code	mm	L mm	g	
77 40 10 01	65 x 43	310-750	65	1

Pipe cutters, Miscellaneous tools

12920NR-1 Replacement mirror for No 12920N

Code	g	g	g
79 40 1001	43	1	

12920NR-2 Stainless steel replacement mirror for No 12920N

Code	g	g	g
79 40 1002	43	1	

12921N Telescopic mirrors



Code	∅ mm	L mm	g	g
77 40 10 30	30	265-705	108	1
77 40 10 40	40	275-715	115	1
77 40 10 50	50	285-725	110	1
77 40 10 60	60	295-735	130	1

12921NR Replacement mirror for 12921N

Code	∅ mm	g	g
79 40 10 30	30	10	1
79 40 10 40	40	15	1
79 40 10 50	50	20	1
79 40 10 60	60	27	1

13120N Telescopic mirror

Illuminated (LED) and with batteries (approx. 150 hours of light), for inspecting numerous kinds of joints. The LED light source can be detached and used as a separate penlight. The concave mirror provides 5-times magnification. With non-twisting, oval-section telescopic rod.



Code	∅ mm	L mm	g	g
77 48 00 02	55	310-750	235	1

13120R Replacement concave mirror for No 13120N, No 13120-1

Code	g	g
79 40 10 55	22	1

12922E Claw lifter

with ergonomic handle.



Code	∅ mm	L mm	g	g
77 40 11 03	6	540	113	1
77 40 72 03	8	540	148	1

12941N Soldering gun

230 V, 50-60 Hz, 100 W.



Code	g	g
96 77 42 00	839	1

12941R/4 Replacement tip for soldering gun No 12941N

Code	g	g
79 14 00 06	9	1

12943N Soldering iron

230 V, 50-60 Hz.



Code	W	g	g
77 42 00 30	30	224	1
77 42 00 60	60	276	1

12943R Replacement tips for No 12943N

Code	size	g	g
79 14 00 30	30	7	1
79 14 00 60	60	31	1

12965N Safety knife

- Blade adjustable by means of slider
- Spare blades can be stored inside the handle
- Blade changes without tools
- With hanging hole
- Ideally suited for cutting card, rubber, leather, wood etc.
- Tool body made of cast zinc.



Code	L mm	g	g
77 62 10 01	174	200	1

12965-1 Self-retracting cutter

- With automatic blade retraction
- Spare blades can be stored inside the handle
- Blade changes without tools
- With hanging hole
- Ideally suited for cutting card, rubber, leather, wood etc.
- Tool body made of cast zinc.



Code	L mm	g	
77 62 1002	174	197	1

12965R Spare blades

5 pieces,
for No 12965N, 12965-1.



Code	g	
79 25 0001	25	20

12965-2 Snap-off blade cutter 9 mm

- With three 9 mm snap-off blades (one blade fitted, two in the magazine)
- Slider with blade-locking function
- Includes blade snap-off tool and protective cap
- With stainless steel blade guide
- Ideally suited for cutting card, rubber, leather, wood etc.
- Tool body made of cast zinc.



Code	L mm	g	
77 62 1003	145	60	1

12965-2R Spare blades 9 mm

10 pieces, für No 12965-2.



Code	g	
79 25 1003	26	1

12965-3 Snap-off blade cutter 18 mm

- With three 18 mm snap-off blades (one blade fitted, two in the magazine)
- Slider with blade-locking function
- Automatic blade reloading
- Ergonomic design with synthetic caoutchouc inlay
- With stainless steel blade guide and hanging hole
- Ideally suited for cutting card, rubber, leather, wood etc.
- Tool body made of cast zinc.



Code	L mm	g	
77 62 1004	168	249	1

12965-3R Spare blades 18 mm

10 pieces, for No 12965-3.



Code	g	
79 25 1004	75	1

12967 Wire stripping knife with hooked blade



for cutting round the outer cable insulation and longitudinal cuts.

- accurate, fast and safe stripping of all popular round cables from 4-28 mm Ø.
- no damage to the inner conductors thanks to infinitely variable adjustment of the cutting depth.



Code	g	
77 62 00 10	80	1

12967R Spare blade for No 12967



Code	g	
79 25 00 10	2	1

13126-1 LED torch

Ex

- Ex-rated for zone 1
- Certifications: SEV 08 ATEX 0164, II 2G Ex e ib IIC T4, II 2D Ex e ibD 21 T98°C.
- Powerful, extremely durable 2 watt LEDs
- Robust, electrically non-conducting, corrosion-proof housing made of ABS/polycarbonate
- High impact resistance and reduced glare thanks to rubber sheathed bezel
- Consistently bright beam throughout 80% of the lifetime of the alkaline batteries due to eLED circuitry
- Zoom with a twist of the bezel
- Rubberised front pushbutton for continuous or momentary action
- Waterproof to IP 68 down to 3 m depth of water
- Hydrogen scrubber catalyst, polarised battery contacts and 0-psi vent minimize explosive risk from leaking batteries
- Battery compartment designed to facilitate rapid battery change
- Brightness: 77 lumen
- Range: 100 m
- Burn time: 5 hrs.
- Batteries: 4 AA/LR06, alkaline, 1.5 V (not supplied).



Code	dimensions	g	
77 49 00 11	170 x 40 x 35 mm	79	1

Pipe cutters, Miscellaneous tools

13126-2 LED penlight

Ex

- Ex-rated for zone 1
- Certifications: II 2G Ex e ib IIB T4 Gb, II 2D Ex ib IIIC T60°C IP6X Db.
- Three times brighter than conventional pen torches thanks to powerful LEDs
- Robust, electrically non-conducting, corrosion-proof housing made of ABS/polycarbonate
- High impact resistance and reduced glare thanks to rubber sheathed bezel
- Consistently bright beam throughout 80% of the lifetime of the alkaline batteries due to eLED circuitry
- Rubberised rear pushbutton for continuous or momentary action
- Easy storage due to integrated clip holder close to bezel
- Waterproof to IP 68 down to 3 m depth of water
- Brightness: 35 lumen
- Range: 64 m
- Burn time: 3 hrs.
- Batteries: 2 AAA/LR03, alkaline, 1.5 V (not supplied).



Code	dimensions	g	g	g
77 49 00 12	132 x 24 x 22 mm	32	1	1

13126-3 LED headlamp

Ex

- Ex-rated for zone 1
- Certifications: SEV 08 ATEX 0163X, II 2G Ex ib IIC T4, II 2D Ex ibD 21 T55°C.
- Waterproof construction for use in all weather conditions
- Three beam modes - white spot, white diffused and red diffused
- High and low power settings
- Large-format ON/OFF button can be easily operated even when wearing heavy gloves
- LED torch module can be removed from housing and used as stand-alone portable working torch
- Beam adjustable using twist knob - no breakable hinges
- With adjustable, elasticated textile strap
- Durable, high-impact construction made of ABS/polycarbonate
- Waterproof to IP 68 down to 10 m depth of water
- Brightness: 65 lumen
- Range: 60 m
- Burn time: 13 hrs.
- Batteries: 3 AAA/LR03, alkaline, 1.5 V (not supplied).



Code	dimensions	g	g	g
77 49 00 13	76 x 38 x 45 mm	81	1	1

13128 LED torch

- High-end power LED.
- Fast adjustment of light beam thanks to single-handed zoom action.
- Switch with textured profile for 2-stage steady light or flash-light function.
- Designed to facilitate rapid battery change.
- Convenient belt-mounted holder with Velcro fastener.
- Brightness: 320 lumen.
- Range: 260 m.
- Burn time: 50 hrs.
- Batteries: 4 batteries, AAA/LR03, 1.5 V.



Code	dimensions	g	g	g
77 49 00 04	130 x 37 x 37 mm	250	1	1

13130 Tweezers

straight, blunt, finely milled inside, stainless steel.



Code	L mm	g	g	g
77 50 00 01	160	26	5	5

13131 Tweezers

bent, blunt, finely milled inside, stainless steel.



Code	L mm	g	g	g
77 51 00 01	155	21	5	5

13148 Wire cutter

- for cutting cables, brass, copper, aluminium
- strain-free working thanks to comfy-fit 2-component handle with finger rest
- cutting edges made of stainless steel (INOX HRC 56)
- one wavy/saw edge



Code	L mm	g	g	g
75 27 00 02	150	93	1	1





9 | PULLERS

STANDARD PULLERS, PULLERS
→ PAGE 300



COUNTER STAYS, SLIDE HAMMERS, SEPARATING FIXTURES
→ PAGE 302



BALL JOINT SEPARATORS
→ PAGE 303





STAHLWILLE Pullers

1

Designed with practical applications in mind, drop forged, precision machined on the latest machine tools, hardened and tempered. STAHLWILLE pullers are conscientiously assembled and tested under load. They are ideal tools for removing gearwheels, ball bearings and pulleys from shafts, axles etc.

2

Product benefits at a glance

- high flexural strength thanks to struts with accurately calculated profiles and milled, smooth guides.
- highly load-bearing extractor hooks made of oil-hardened chrome vanadium steel with milled-profile jaws and specially-designed grip geometry for use in confined spaces and optimised radii for shafts and axles.
- smooth running and high force transmission through the nut with its hard-wearing, smooth thread contours.
- high extraction force with ease is made possible even where there is high friction and counterforces due to the CNC milled precision thread.
- damage to the thread of the nut is effectively prevented, even if the full length of the thread is used, due to the clearance at the end of the thread.
- excellent running characteristics of the thread itself thanks to high-grade hardening and tempering and the special coatings on the thrust spindles.
- to enable stubborn parts to be loosened, it may be necessary to tap the puller with a hammer after it has been tensioned. For this reason, the spindle head is equipped with a rounded impact head.
- close-tolerance, performance-matched jaw sizes on the spindle head ensure non-slip contact with the drive tool.
- to prevent damage to the shafts while extraction force is applied, the centre is freely-swivelling.

3

Numerous pullers are available for different applications:

Standard pullers, battery terminal pullers, ball joint separators, internal pullers, counter stays, separating fixtures, wheel hub pullers.

4

After attaching and locking the puller No 11060/11061 **1**, the central threaded spindle **2** is turned to ease the bearing off its mount without causing damage.





1 Battery terminal puller in use on a car battery

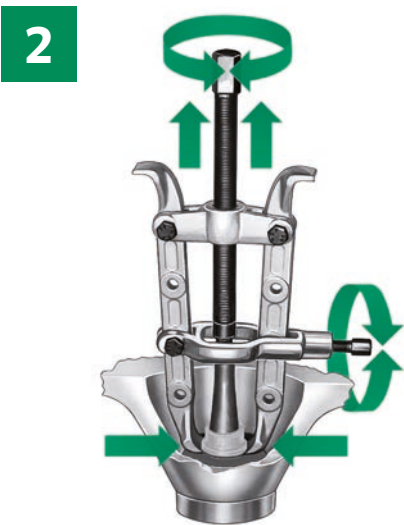

2 How a two-armed puller works

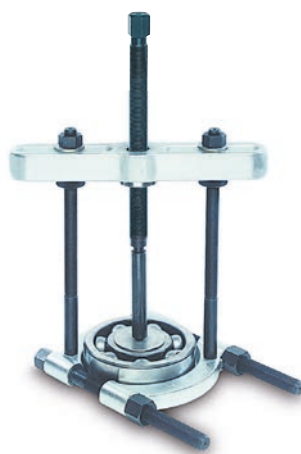

Separating fixture in use for removing ball bearings



Puller in use for removing gearwheels



Standard pullers
Two- or three-armed puller? A three-armed puller is generally preferable to a two-armed one provided there is sufficient space because it distributes the pulling forces more evenly.

Pullers

11050 Standard pullers

two-armed, with sliding permanently parallel extractor hooks, zinc plated; for extracting gearwheels, ball bearings, pulleys and similar parts from shafts or axles; for removing ball bearings, bearing outer races and bushes from holes; hooks can be used as internal or external hooks.



Code	size	Clamp. width mm	Clamp. depth mm	Max. loading in t	Max. torque in N-m	△△ g	
71 1300 11	1	25-80	100	4.5	80	999	1
71 1300 12	2	25-130	100	4.5	80	1103	1
71 1300 13	3	50-160	150	6.5	150	2754	1
71 1300 14	4	60-200	150	6.5	150	3085	1
71 1300 15	5	80-250	200	11.0	320	7000	1
71 1300 16	6	80-350	200	11.0	320	8400	1

H 11050 Arms for pullers No 11050/11051

1 piece

Code	size	for puller No	△△ g	
79 1300 11	1	11050-1, -2 11051-1, -2	238	1
79 1300 12	3	11050-3, -4 11051-3, -4	602	1
79 1300 13	5	11050-5, -6	1596	1



11053 Standard pullers

two-armed, with swivelling extractor hooks for larger reaches, zinc plated; for extracting gearwheels, ball bearings, pulleys and similar parts from shafts or axles; hooks can be used as internal or external hooks; for internal extraction, simply turn the hooks and spindle round; the large leverage effect ensures a firm grip on the part to be extracted, whether internal or external.



Code	size	Clamp. width mm	Clamp. depth mm	Max. loading in t	Max. torque in N-m	△△ g	
71 1502 11	1	50-300	270	6.0	120	4330	1
71 1502 12	2	50-400	400	6.0	120	6000	1

11051 Standard pullers

three-armed, with sliding permanently parallel extractor hooks, zinc plated; for extracting gearwheels, ball bearings, pulleys, fan wheels and similar parts from shafts or axles; for removing ball bearings, bearing outer races and bushes from holes; hooks can be used as internal or external hooks.



Code	size	Clamp. width mm	Clamp. depth mm	Max. loading in t	Max. torque in N-m	△△ g	
71 0800 11	1	25-80	100	5.5	55	1280	1
71 0800 12	2	25-120	100	5.5	55	1422	1
71 0800 13	3	25-160	150	7.0	70	3507	1
71 0800 14	4	25-200	150	7.0	70	3690	1

11054 Pullers

three-armed, with swivelling extractor hooks for larger reaches, zinc plated; for extracting gearwheels, ball bearings, pulleys and similar parts from shafts or axles; hooks can be used as internal or external hooks; for internal extraction, simply turn the hooks and spindle round; the efficient leverage effect forces the hooks firmly onto the part to be extracted.



Code	size	Clamp. width mm	Clamp. depth mm	Max. loading in t	Max. torque in N-m	△△ g	
71 1503 11	1	50-300	270	12.0	220	4990	1
71 1503 12	2	50-400	400	12.0	220	8000	1

11056 Set: Pullers

consisting of the most common two- and three-armed pullers with two- and three-armed, sliding, parallel extractor hooks. for extracting gearwheels, ball bearings, pulleys and similar parts from shafts or axles; hooks can be used as internal or external hooks; the efficient leverage effect forces the hooks firmly onto the part to be extracted.



Code	Clamp. width mm	Clamp. depth mm	△△ g	
96 71 13 11	120	100/200/250	7000	1

12150 Pullers

two-armed version with swivelling, double-action extractor hooks, zinc plated; for extracting gearwheels, ball bearings, pulleys and similar parts from shafts or axles; for removing ball bearings, bearing outer races and bushes from holes; for internal extraction, simply swivel the hooks and turn the spindle round or just turn the hooks round.



Code	size	Clamp. width mm	Clamp. depth mm	Max. loading in t	Max. torque in N·m	Δ g	
71 1402 11	1	20-150	80	3.5	50	708	1
71 1402 12	2	40-220	130	4.0	60	1675	1

12152 Three arm pullers

three-armed version with swivelling, double-action extractor hooks, zinc plated; for extracting gearwheels, ball bearings, pulleys and similar parts from shafts or axles; for removing ball bearings, bearing outer races and bushes from holes; for internal extraction, simply swivel the hooks and turn the spindle round or just turn the hooks round.



Code	size	Clamp. width mm	Clamp. depth mm	Max. loading in t	Max. torque in N·m	Δ g	
71 1403 11	1	20-150	80	4.0	60	920	1
71 1403 12	2	40-200	130	4.5	70	2235	1

11055 Two arm pullers

two-armed, with swivelling extractor hooks and lateral clamp clip, zinc plated; when the clamp clip is tightened, the claws of the extractor hooks locate under the part to be extracted and lever it free as force is applied before extraction begins; for extracting gearwheels, ball bearings, pulleys, drop arms and similar parts from shafts or axles; the clamp clip presses the extractor hooks firmly against the part being extracted.



Code	size	Clamp. width mm	Clamp. depth mm	Max. loading in t	Max. torque in N·m	Δ g	
71 1900 11	1	20-70	85	5.0	120	1211	1
71 1900 12	2	20-100	100	6.0	120	1643	1
71 1900 13	3	30-150	150	8.0	150	2907	1

11040 Battery terminal pullers

two-armed, with a self-centring quick-action clamp and automatic feed, zinc plated; for extracting battery terminal clamps, smaller ball bearings, pulleys etc.; as force is applied through the spindle, the extractor hooks automatically apply increasing force to the part being extracted; particularly suited to car electrics, compressed air system repairs and similar applications due to the compact design and small hooks.



Code	size	Clamp. width mm	Clamp. depth mm	Max. loading in t	Max. torque in N·m	Δ g	
71 1200 11	1	10-60	45	2.5	25	245	1
71 1200 12	2	10-70	65	3.0	35	261	1
71 1200 13	3	10-100	80	3.5	45	315	1

11042 Battery terminal pullers

three-armed, with a self-centring quick-action clamp and automatic feed, zinc plated; for extracting battery terminal clamps, smaller ball bearings, pulleys etc.; as force is applied through the spindle, the extractor hooks automatically apply increasing force to the part being extracted; particularly suited to car electrics, compressed air system repairs and similar applications due to the compact design and small hooks.



Code	size	Clamp. width mm	Clamp. depth mm	Max. loading in t	Max. torque in N·m	Δ g	
71 1800 11	1	10-60	45	2.5	25	299	1
71 1800 12	2	10-70	65	3.0	35	340	1
71 1800 13	3	10-100	80	3.5	45	692	1

11060 Internal pullers

for extracting ball bearings, bearing outer races and bushes, zinc plated; to be used with Counter stay No 11061 and Slide hammer No 11062; even bearings which are tight up against the walls are securely gripped due to the excellent clamping effect.



Code	size	Clamp. width mm	Max. torque in N·m	Δ g	
71 1600 10	0	8-12	30	102	1
71 1600 11	1	12-16	30	110	1
71 1600 21	1a	16-20	30	116	1
71 1600 12	2	20-27	30	131	1
71 1600 13	3	27-36	60	365	1
71 1600 15	5	36-46	60	385	1
71 1600 16	6	46-58	60	558	1
71 1600 17	7	58-70	60	612	1
71 1600 18	8	70-100	60	1659	1

Pullers

11061 Counter stays

to be used with Internal Puller No 11060; zinc plated; insert and open up the internal puller; screw the spindle of the counter-stay into the internal puller; extract the workpiece.



Code	size	suitable for No 11060	Max. torque in N-m	△△ g	📦
71170011	1	sizes 0-2	30	654	1
71170012	2	sizes 3-7	60	1518	1
71170013	3	size 8	60	2317	1

11062 Slide hammers

to be used with Internal Puller No 11060; zinc plated; for extracting ball bearings if it is not possible to use Puller No 11061 because there is insufficient space.



Code	size	suitable for No 11060	△△ g	📦
71161001	1	sizes 0-2	650	1
71161002	2	sizes 3; 5	1435	1

12613 Separating fixtures

zinc plated; for use with No 12614 of same sizes; for separating and extracting ball bearings, roller bearings, bushes, wheels and other tightly fitting parts; applying uniform pulling force to the side bolts will gently separate workpieces; apply puller No 12614; apply force to pull off.



Code	size	Clamp. width mm	Opening mm	Max. loading in t	Max. torque in N-m	△△ g	📦
71030010	0	5-60	60	2.0	30	562	1
71030011	1	12-75	75	2.5	40	787	1
71030012	2	22-115	115	4.0	70	2020	1
71030013	3	30-155	155	5.0	90	3740	1

12614 Pullers

zinc plated; for use with No 12613 of same sizes; for extracting ball bearings, roller bearings, bushes, wheels and other tight fitting parts; the puller is connected to separator No 12613 to enable the workpiece to be extracted.



Code	size	Clamp. width mm	Extraction bolts mm	Max. loading in t	Max. torque in N-m	△△ g	📦
71040010	0	45-110	110	2.0	30	910	1
71040011	1	55-140	155	2.5	40	1220	1
71040012	2	60-215	200	4.0	70	2802	1
71040013	3	85-295	315	5.0	90	6820	1

V 12614 Extensions

1 pair, for use with puller No 12614; extensions for the extraction bolts on the puller for use with longer workpieces.



Code	size	for No	L mm	△△ g	📦
79440011	1	12614-0, -1	100	89	1
79440012	2	12614-2	150	233	1
79440013	3	12614-3	150	743	1

11030 Universal wheel hub pullers

with three extractor hooks, zinc plated; for extracting wheel hubs on HGV's and cars up to a hole diameter of 225 mm; the axially mounted threaded bush enables the workpiece to be freed by gently tapping the end of the spindle.



Code	size	Max. loading in t	Max. torque in N-m	△△ g	📦
71110013	1	3	14.0	280	3566
71110015	2	5	14.0	280	4568

H 11030 Arm for No 11030

1 piece

Code	△△ g	📦
79100010	524	1

11041 Ball joint separators

for forcing out ball pins on vehicles, zinc plated.

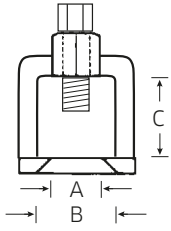

Code	size	A mm	B mm	C mm	Max. torque in N-m	⚖️ g	📦
71 23 00 11	1	18	37	37	50	309	1
71 23 00 12	2	23	45	45	120	476	1
71 23 00 13	3	29	55	60	160	1321	1
71 23 00 14	4	39	70	80	280	2024	1

size 1 for passenger vehicles

size 2 for passenger vehicles and vans

size 3 + 4 for trucks

SP 11040-12150 Spindles

Code	No	for puller No	⚖️ g	📦
79 28 10 11	SP 11040-1	11040-1; 11042-1	108	1
79 28 11 11	SP 11040-2	11040-2; 11042-2	120	1
79 28 10 12	SP 11040-3	11040-3; 11042-3	80	1
79 28 10 13	SP 11050-1	11050-1, -2; 11051-1, -2; 11056; 12150-1, 12152-1, 12614-0, -1	171	1
79 28 10 14	SP 11050-3	11050-3, -4; 11051-3, -4; 12614-2	590	1
79 28 10 15	SP 11050-5	11050-5, -6	1210	1
79 28 10 16	SP 11055-1	11055-1	177	1
79 28 10 17	SP 11055-2	11055-2	176	1
79 28 10 18	SP 11055-3	11055-3	592	1
79 28 10 19	SP 11041-1	11041-1	80	1
79 28 10 20	SP 11041-2	11041-2	94	1
79 28 10 21	SP 11041-3	11041-3	360	1
79 28 10 22	SP 11041-4	11041-4	231	1
79 28 10 23	SP 11053-1	11053-1, -2; 11054-1, -2	876	1
79 28 10 34	SP 12150-2	12150-2; 12152-2	440	1

12616 Universal ball joint separator

zinc plated, DIN/ISO 7803, for extracting ball-joints on cars and light delivery vans.



Code	size	Fork opening mm	Clear height mm	Max. loading in t	Max. torque in N-m	⚖️ g	📦
71 05 00 10	1	18-22	20-50	3.5	70	611	1

12623 Ball joint separator

zinc plated; for extracting ball-joints especially on BMW, Fiat, Ford, Mercedes-Benz, Nissan, Opel, Toyota, VW/Audi and Volvo cars.



Code	Fork opening mm	Clear height mm	Max. loading in t	Max. torque in N-m	⚖️ g	📦
71 05 00 11	20	12-50	3.5	40	1284	1

12623-1 Ball joint separator

for vehicles with aluminium chassis; zinc plated; for extracting ball-joints, especially on Audi A6 and A8 after model year 1999 and for other vehicles with limited work space.



Code	Fork opening mm	Clear height mm	Max. loading in t	Max. torque in N-m	⚖️ g	📦
71 05 00 12	24	60-80	3.5	40	1577	1

12623-3 Ball joint separator

on heavy goods vehicles, buses and construction site vehicles; zinc plated.



Code	Fork opening mm	Clear height mm	Max. loading in t	Max. torque in N-m	⚖️ g	📦
71 05 00 14	35-45	115	20	200	6000	1

12623-4 Ball joint separator

on medium-sized and heavy HGV's, buses and construction site and other special vehicles; zinc plated.



Code	Fork opening mm	Clear height mm	Max. loading in t	Max. torque in N-m	⚖️ g	📦
71 05 00 15	27-36	90	10	100	2995	1



10 | SPECIAL AUTOMOTIVE TOOLS

KABELEX® TOOLS AND SETS

→ PAGE 308



KABELEX® RANGE

→ PAGE 347



CAR BODY REPAIR TOOLS

→ PAGE 311



TOOLS FOR VEHICLE DOORS

→ PAGE 314



TOOLS FOR FITTING/REMOVING VEHICLE GLASS

→ PAGE 315



WORKSHOP SETS

→ PAGE 317



SPECIAL TOOLS FOR CARS

→ PAGE 330



SPECIAL TOOLS FOR HGVS

→ PAGE 344



STAHLWILLE special automotive tools



Together with leading automotive manufacturers, STAHLWILLE develops special-purpose tools and brand-specific sets of tools. This continuous development and enhancement process covering tools for production and workshops ensures that the tools we make keep pace with the latest developments in the industry.

1

Tidy tool management: STAHLWILLE tool sets for car repairs

Carefully selected suites of tools for Tool Trolleys and Tool Boxes ensure optimised workflows. Whether it is in the garage, in production or in the pits, many mechanics welcome the benefits afforded by model and marque specific tools to guarantee safe, timesaving work.

2

Problem solver: STAHLWILLE special-purpose car pliers

Often enough, corroded or jammed parts in hard-to-reach places slow down repair and servicing jobs in the engine space. With diesels, this includes the heater plug sockets. STAHLWILLE heater plug socket pliers make it that much easier to remove and refit these plug sockets, especially when the engine is still hot.

3

Better safe than sorry: STAHLWILLE sockets

It would be hard to imagine garage and production environments without compressed air tools. Hardly surprising, then, that STAHLWILLE offer such a wide range of tried-and-tested, job-specific sockets, e. g. the wheel-nut socket with the closely-fitting plastic sleeve. This prevents damage to wheel bolts, wheel nuts and the bolt holes especially on alloy wheels.

4

The specialists: STAHLWILLE KABELEX®

Efficiency and economy in the workplace – at a time when it pays to be competitive, removing cables on vehicles safely and quickly gives you that advantage. This is why STAHLWILLE offers over 40 different cable removing tools for cars. They are available individually, in carefully selected sets or as special sets for specific vehicles. The fine but highly resistant blades are made of chrome vanadium and special spring steel.

5

Unbreakable: Special tools for car glass

The professionals really appreciate STAHLWILLE products for quickly and accurately removing and fitting car glass. Twin suction lifters and a three-component glass removal set ensure that windscreens and other car glass are easily and safely removed, fitted and transported.



6

A question of torque: Friction gauger

Setting steering systems accurately is a critical job - and adhering to torque settings and coefficients of friction is a crucial part of it. This is what STAHLWILLE created the easily-operated Friction gauge No 73Nm/15 with a range of 2-15 N-m.

1



2



3



4



5



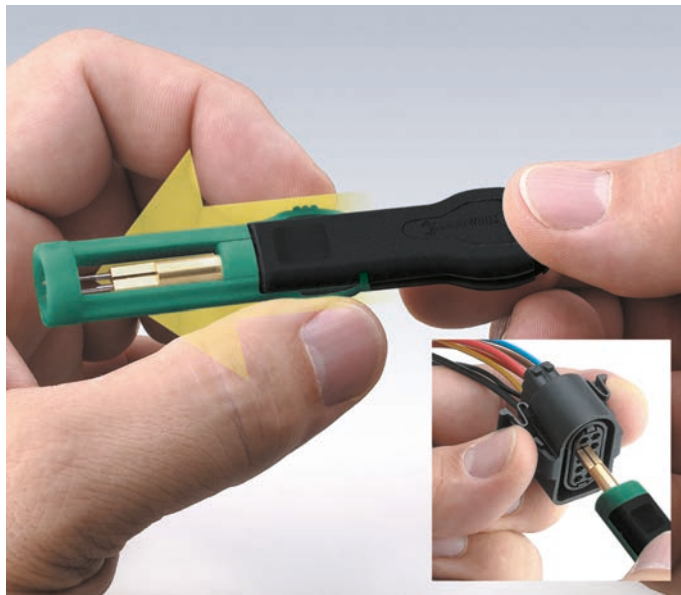

STAHLWILLE KABELIX® Protect

For workshops and cable configuration
(KABELIX® table see page 322)

- Bicoloured handle:
 - with locking blade cover, to protect the fine blade and guard against injury.
 - easier to handle for fine and intricate work on miniature connectors.
- Releases cable connectors quickly and easily without cutting them off - saves time and money.
- Also available in carefully selected sets.
- Special sets for vehicle makes: BMW, Mercedes-Benz, Opel, VW/Audi/Seat/Skoda/Porsche, MAN/Volvo and Renault/PSA
- Over 40 different cable extractors available.
- Blades made of extremely tough and durable chrome vanadium and special spring steel.

1501-1506 Ejection tools KABELIX®

for round snap-in receptacles, including dismantling sleeve.



Code	No	for contact sizes		g	☐
		∅ mm	g		
96 74 62 30	1501 + 1511 (e.g. BMW, Mercedes-Benz, Fiat, MAN, Opel, Porsche, Seat, Skoda, VW/Audi)	1.5	45	1	
96 74 62 31	1502 + 1512 (e.g. BMW, Mercedes-Benz, Fiat, MAN, Opel, Porsche, Seat, Skoda, VW/Audi)	3.5	59	1	
96 74 62 32	1503 + 1513 for ABS (lorries) please order corresponding assembly sleeve No 1523 (e.g. Mercedes-Benz, MAN, Scania) separately	4.0	79	1	
96 74 62 33	1504 + 1514 (e.g. BMW, Mercedes-Benz, Opel)	2.5	60	1	
96 74 62 34	1505 + 1515 (e.g. Ford, Opel, PSA, Renault)	2.3	46	1	
96 74 62 35	1506 + 1516 (e.g. Mercedes-Benz trucks, MAN, Scania)	4.0	72	1	

1511-1518 Dismantling sleeves KABELIX®



Code	No	for contact sizes		L mm	inside ∅ mm	outside ∅ mm	g	☐
		∅ mm	g					
78 60 00 01	1511 for No 1501	1.5	30	2.9	3.3	1	10	
78 60 00 02	1512 for No 1502	3.5	30	4.4	5.0	1	10	
78 60 00 03	1513 for No 1503	4.0	45	6.0	6.5	1	10	
78 60 00 04	1514 for No 1504	2.5	30	4.0	4.4	1	10	
78 60 00 05	1515 for No 1505	2.3	35	3.0	3.3	1	10	
78 60 00 06	1516 for No 1506 (for 4.0 mm MOLEX-contacts)	4.0	35	5.6	6.0	1	10	
78 60 00 16	1516-A for No 1506 (for 4.0 mm AMP-contacts)	4.0	30	5.4	5.8	1	10	
78 60 00 07	1517 for No 1507	1.5	26	2.3	2.8	1	10	
78 60 00 18	1518 for No 1508 (3 x 120° geschlitzt)	1.5	32	2.7	3.5	1	5	

1523 Assembly sleeve KABELIX® ABS

for No 1503



Code	for contact sizes		L mm	inside ∅ mm	outside ∅ mm	g	☐
	∅ mm	g					
78 61 00 01	4.0	50	4.0	6.5	5	3	

1551/1552 Cable extractor tools KABELIX®

for flat snap-in receptacles e.g. BMW, Ford, Opel, Porsche, Seat, Skoda, VW/Audi.



Code	No	for contact sizes		g	☐
		∅ mm	g		
74 62 00 01	1551	2.8	19	1	
74 64 00 02	1552	5.8	19	1	

1553-1555 Cable extractor tools KABELIX®

for flat plug-in sockets locked in terminals with single release channel.



Code	No	for contact sizes		g	☐
		∅ mm	g		
74 62 00 03	1553 (e.g. BMW, Mercedes-Benz, Ford, MAN, Opel, Porsche, PSA, Renault, Seat, Skoda, VW/Audi)	2.8; 5.8	16	1	
74 62 00 04	1554 (e.g. BMW, PSA, Renault)	2.8	16	1	
74 62 00 05	1555 (e.g. BMW)	5.8	16	1	

1556 Cable extractor tool KABELIX®

for flat plug-in sockets, Micro Timer II, III contacts, e.g. Mercedes-Benz, Opel, Porsche, PSA, Renault, Saab, Seat, Skoda, VW/Audi.



Code	for contact sizes		g	☐
	∅ mm	g		
74 62 00 06	1.6	17	1	

1556-1 Cable extractor tool KABELEX®

for flat plug-in sockets with asymmetrically positioned latches in terminals with two release channels, Seat, Skoda, VW/Audi.



Code	for contact sizes □ mm	Δ g	
7461 2006	0.64	19	1

1557/1558 Cable extractor tools KABELEX®

for flat plug-in sockets with asymmetrically positioned latches in terminals with two release channels, Seat, Skoda, VW/Audi.



Code	No	for contact sizes □ mm	Δ g	
7462 0007	1557	2.8	21	1
7462 0008	1558	4.8	22	1

1559 Cable extractor tool KABELEX®

for flat plug-in sockets, Maxi Power Timer contacts, Mercedes-Benz, VW/Audi.



Code	for contact sizes □ mm	Δ g	
7462 0009	9.5	39	1

1562 Cable extractor tool KABELEX®

for flat plug-in sockets, Pit-Pod contacts, all vehicle makes.



Code	for contact sizes □ mm	Δ g	
7462 0012	various	25	1

1574 Cable extractor tool KABELEX®

for flat plug-in sockets, Micro-Timer I contacts and ABS plug-in housing, Fiat, Ford, Mazda, Opel, PSA, Renault, Saab, VW/Audi.



Code	for contact sizes □ mm	Δ g	
7462 0024	1.6	15	1

1575 Cable extractor tool KABELEX®

for round soldered pin contacts, Ford, for flat plug-in sockets (retention by locking device on terminal), Fiat, Mazda, Toyota.



Code	for contact sizes ∅ mm	for contact sizes □ mm	Δ g	
7462 0025	1.5	2.8; 5.8	15	1

1576 Cable extractor tool KABELEX®

for flat plug-in sockets with single latch (flat plug without box), e.g. MAN.



Code	for contact sizes □ mm	Δ g	
7462 0026	2.8	18	1

1577 Cable extractor tool KABELEX®

for flat plug-in sockets, VKR Box contacts, e.g. MAN.



Code	Δ g	
7462 0027	49	1

1577-1 Cable extractor tool KABELEX®

for flat plug-in sockets, MKR/MKS contacts, e.g. MAN/Volvo.



Code	for contact sizes □ mm	Δ g	
7461 5027	1.5	23	1

1578K-1 Cable extractor tool KABELEX®

for flat plug-in sockets, SLK contacts (primary), e.g. BMW, Mercedes-Benz.



Code	for contact sizes □ mm	Δ g	
7461 0028	2.8	35	1

1578K-2 Cable extractor tool KABELEX®

for flat plug-in sockets, SLK contacts 97 (primary, secondary), e.g. BMW, Mercedes-Benz.



Code	for contact sizes □ mm	Δ g	
7461 2028	2.8	35	1

1584/1585 Cable extractor tool KABELEX®

for round soldered contacts, Mercedes-Benz.



Code	No	for contact sizes ∅ mm	Δ g	
7462 0034	1584	4.0	13	1
7462 0035	1585	2.5	11	1

Special automotive tools

1587 Cable extractor tool KABELEX®

for flat plug-in sockets,
E-95 contacts, Mercedes-Benz.



Code	for contact sizes □ mm	⚠ g	📦
74620037	1.65	23	1

1589K Cable extractor tool KABELEX®

for flat plug-in sockets,
LSK contacts,
e.g. BMW, Mercedes-Benz.



Code	for contact sizes □ mm	⚠ g	📦
74610039	8	45	1

1591 Cable extractor tool KABELEX®

for flat plug-in sockets in terminals
with two release channels,
Junior Power Timer contacts,
Standard Power Timer contacts,
e.g. BMW, Mercedes-Benz, Fiat, Ford,
MAN, Opel, PSA, Renault, Saab, VW/Audi.



Code	for contact sizes □ mm	⚠ g	📦
74620041	2.8; 5.8	25	1

1700 MAN/Volvo Tool set KABELEX®

14 pieces, for MAN/Volvo,
Mercedes-Benz trucks.

Content:

No 1501, 1502, 1503, 1506:
ejection tools for contact sizes
∅ 1.5; 3.5; 4.0 (ABS) and 4.0 mm

No 1511, 1512, 1513, 1516:
dismantling sleeves for contact
sizes ∅ 1.5; 3.5; 4.0 (ABS) and
4.0 mm

No 1523: assembly sleeve (ABS)

No 1553, 1591: cable extractor tools for contact sizes
□ 2.8 and 5.8 mm

No 1576: cable extractor tool for flat plugs without box □ 2.8 mm

No 1577: cable extractor tool for VKR Box contacts □

No 1577-1: cable extractor tools for MKR/MKS contacts □ 1.5 mm



Code	⚠ g	📦
96747208	1773	1

1560 Tool set KABELEX®

10 pieces, for round plug
connections (incl. ABS).

Content:

1 each No 1501: ejection tool for
contact sizes ∅ 1.5 mm

1 each No 1502: ejection tool for
contact sizes ∅ 3.5 mm

1 each No 1503: ejection tool for
contact sizes ∅ 4.0 mm
assembly or dismantling sleeve
(ABS)

2 each No 1511: dismantling sleeves for contact sizes ∅ 1.5 mm
(1 each mounted)

2 each No 1512: dismantling sleeves for contact sizes ∅ 3.5 mm
(1 each mounted)

2 each No 1513: dismantling sleeves for contact sizes ∅ 4.0 mm
(1 each mounted)

1 each No 1523: assembly sleeve (ABS)



Code	⚠ g	📦
96747201	733	1

1570/2 Universal set KABELEX®

12 pieces.

Content:

No 1501, 1502, 1505: ejection tools
for contact sizes
∅ 1.5; 3.5; 2.3 mm

No 1511, 1512, 1515: dismantling
sleeves for contact sizes
∅ 1.5; 3.5; 2.3 mm

No 1553: cable extractor tool for
plugs with one release channel
□ 2.8 and 5.8 mm

No 1556: cable extractor tool for Micro-Timer II, III contacts
□ 1.6 mm

No 1559: cable extractor tool for Maxi-Power Timer contacts
□ 9.5 mm

No 1562: cable extractor tool for Pit-Pod contacts

No 1574: cable extractor tool for Micro-Timer I contacts and ABS plug-in
housing □ 1.6 mm

No 1591: cable extractor tool for plugs with two release channels
□ 2.8 and 5.8 mm



Code	⚠ g	📦
96747304	962	1

Car body repair tools and pullers

10775 Dinging hammer



Code	∅ mm	L ₁ mm	L ₂ mm	⚖ g	
70 13 00 02	30/40	300	155	516	2

10776 Special planishing hammer

large extra thin faces,
square face chequered.



Code	∅ mm	□ mm	L ₁ mm	L ₂ mm	⚖ g	
70 13 00 10	46	40	320	115	521	2

10780 Planishing hammer

short.



Code	∅ mm	□ mm	L ₁ mm	L ₂ mm	⚖ g	
70 13 00 03	32	25	300	100	346	2

10785 Planishing hammer

short, round face chequered.



Code	∅ mm	□ mm	L ₁ mm	L ₂ mm	⚖ g	
70 13 00 04	40	35	300	96	484	2

10790 Pecking hammer

with round face and ball pein.



Code	∅ mm	L ₁ mm	L ₂ mm	⚖ g	
70 13 00 05	18/41	300	158	480	2

10795 Pecking hammer

with round face and
acorn shaped pein.



Code	∅ mm	L ₁ mm	L ₂ mm	⚖ g	
70 13 00 06	20/41	300	160	460	2

10800 Pecking hammer

short, round flat face
and pointed pein.



Code	∅ mm	L ₁ mm	L ₂ mm	⚖ g	
70 13 00 07	35	300	135	360	2

10805 Pecking hammer

round flat face,
oblong, thin pein,
approx. 1 mm thick.



Code	∅ mm	L ₁ mm	L ₂ mm	⚖ g	
70 13 00 08	40	300	160	450	2

10806 Pecking hammer

extra large thin face and pein.



Code	∅ mm	L ₁ mm	L ₂ mm	⚖ g	
70 13 00 11	40	300	135	382	2

10811 Planishing and grooving hammer



Code	∅ mm	□ mm	L ₁ mm	L ₂ mm	⚖ g	
70 13 00 12	30	36 x 10	320	160	531	2

10812 Planishing and grooving hammer



Code	∅ mm	□ mm	L ₁ mm	L ₂ mm	⚖ g	
70 13 00 13	30	25 x 5	300	115	350	2

Special automotive tools

10835 Wedge dolly



Code	L mm	b mm	h mm	△△ g	
70210002	130	55	32	958	1

10841 Thin dolly

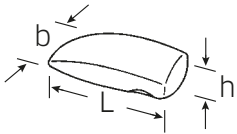

Code	L mm	b mm	h mm	△△ g	
70210005	107	66	28	984	1

10842 Diabolo dolly



Code	∅ mm	h mm	△△ g	
70210006	57	60	658	1

10845 Toe dolly



Code	L mm	b mm	h mm	△△ g	
70210008	120	55	22	770	1

10855 Universal anvil dolly



Code	L mm	b mm	h mm	△△ g	
70210010	70/60	50/45	58	1200	1

10861 Toe dolly

chequered surface.



Code	L mm	b mm	h mm	△△ g	
70210014	120	55	30	1033	1

10865 Heel dolly



Code	L mm	b mm	h mm	△△ g	
70210012	80	60	35	1070	1

 Made in
Germany

10880 Bumping spoon



Code	L ₁ mm	L ₂ mm	⚖ g	📦
70 22 0001	460	200	1900	1

L₁ = length overall
L₂ = working length

10885 Bumping spoon



Code	L mm	⚖ g	📦
70 22 0002	500	2210	1

10890 Body spoon



Code	L ₁ mm	L ₂ mm	⚖ g	📦
70 22 0003	270	130	520	1

10895 Body spoon



Code	L ₁ mm	L ₂ mm	⚖ g	📦
70 22 0004	390	200	1035	1

L₁ = length overall
L₂ = working length

11005 Pry bar

head and point polished.



Code	L mm	∅ mm	⚖ g	📦
72 09 0000	400	14	500	6

11006 Lever bar

special steel, bright nickel-plated.



Code	L mm	B mm	⚖ g	📦
72 09 0002	400	14	500	6

11007 Lever bar

special steel, bright nickel-plated.



Code	L mm	B mm	⚖ g	📦
72 09 0003	400	17	643	6

10905 Body file holder

with coarse blade.



Code	L mm	b mm	h mm	⚖ g	📦
72 16 0000	365	35	110	760	2

L = Length, b = Width, h = Height

10923 Body file holder

made of beechwood,
for flat blades.



Code	L mm	⚖ g	📦
72 20 0002	530	300	1

10906-10916 Spare blades for No 10905 and No 10923

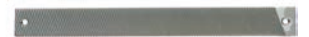

Code	No		teeth per inch	L mm	⚖ g	📦
79 06 0001	10906	fine, radial cut	15	350	321	10
79 06 0002	10907	medium, radial cut	12	350	286	10
79 06 0003	10908	coarse, radial cut	9	350	279	10
79 06 0012	10915	medium, angled cut	12	350	282	10
79 06 0013	10916	coarse, angled cut	9	350	252	10

10922 Body file holder

wooden,
for half round radius file blades.



Code	L mm	⚖ g	📦
72 20 0001	530	260	1

10921 File blades for No 10922



Code	No		teeth per inch	L mm	⚖ g	📦
79 06 0004		coarse, without swarf breaker, half round, radial cut	9	350	216	5

Special automotive tools

12752 Tin snips

lever action, spring-assisted for self-opening action.
Heavy duty cutting:
sheet steel up to 1.8 mm
or stainless steel sheet up to 1.2 mm.



Code	shape	L mm	L "	△△ g	☐
75 23 00 01	L¹⁾	260	10 1/2	532	1
75 23 00 02	R²⁾	260	10 1/2	532	1

¹⁾ left hand cutting ²⁾ right hand cutting

12753 Tin snips

lever action, spring-assisted for self-opening action.
Heavy duty cutting:
sheet steel sheet up to 1.8 mm
or stainless steel sheet up to 1.2 mm.



Code	shape	L mm	L "	△△ g	☐
75 24 00 01	L¹⁾	260	10 1/2	473	1
75 24 00 02	R²⁾	260	10 1/2	473	1

¹⁾ left hand cutting ²⁾ right hand cutting

12727 Spot weld milling cutter

HSSE steel, for spot-weld removal on car body or sheet metal construction.
Replaceable milling cutter size 10 mm.
Cutting depth adjustment by set screw, avoids distortion damage to sheet metal.



Code	L mm	△△ g	☐
72 26 00 01	72	19	5

12728 Replacement milling cutter



Code	L mm	△△ g	☐
79 26 00 01	13	4	10

12729/12730 Spot weld drills

for clean, burr-free removal of spot-weld. Self-cutting centre point avoids running off spot weld. Can be reground.



Code	No	∅ mm	△△ g	☐
72 27 00 07	12729	7	18	5
72 27 00 08	12730	8	24	5

Tools for vehicle doors

12770 Lever bar

powder coated for improved slide effect, for removal of doors trims in cars.



Code	L mm	△△ g	☐
74 59 31 01	260	150	5

12770/2 Lever bar

for levering off fragile caps, decorative trim (strips and rings), switches, rubber or fabric trim without damaging them.
Finely honed, rounded edges ensure the vehicle paintwork and surrounding materials are not damaged or scratched.



Code	L mm	△△ g	☐
74 59 31 02	185	20	1

12770/3 Plastic lever bar

for removing trim and rubbing strips of all kinds on bodywork and around windcreens, rear and side windows.
The broad area of contact prevents damage such as scratching of painted surfaces, deformation of strips and damage of glass.



Code	L mm	△△ g	☐
74 59 00 03	300	209	1



Tools for fitting/removing vehicle glass

10352 Two double suction lifters

Suction cap dia. 120 mm, mechanical action with safety lock. Special ABS-plastic, oil and acid resistant. With belt slots in the handles. Carrying capacity 60 kg.



Code		
74 28 0001	1405 g	1



10352/1 Double suction lifter

Suction cap dia. 120 mm, mechanical action with safety lock. Special ABS-plastic, oil and acid resistant. With belt slots in the handles. Carrying capacity 30 kg.



Code		
74 28 0005	695 g	1

SD10351N Spare cutting wire

special alloy steel 0.6 x 0.6 mm. Easy wire removal without the rest unrolling.



Code	L m		
79 27 00 11	50	170 g	1

10350N Windscreen replacement set VERITRAC

1 guide handle
1 draw handle
1 coil cutting wire (50 m)
2 double suction lifters



Code		
98 74 27 11	1760 g	1

10351/1 Draw handle

for drawing cutting wire through adhesive seal.



Code		
74 27 00 01	90 g	1



10351N Windscreen removal set VERITRAC

as 10350N, but without double suction lifters.



Code		
96 74 27 11	458 g	1



Special automotive tools

10351/2 Guide handle

for fixing and clamping cutting wire inside vehicle.



Code	g	g	g
74 27 00 02	196	1	

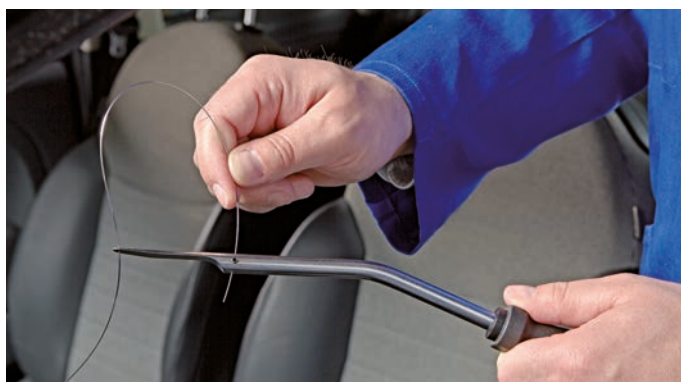
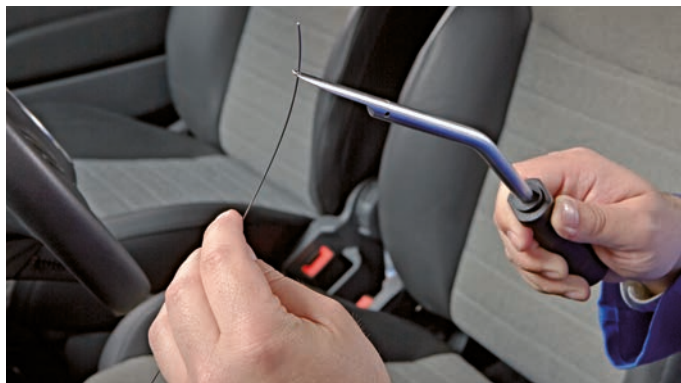

10351/3 Guide handle

for fixing and clamping cutting wire inside vehicle.
Extra long extension makes it especially suited to recessed glass.



Code	g	g	g
74 27 00 06	190	1	

1474/2 Wire insert awl

for feeding or pulling cutting wire through hardened adhesive.



Code	g	g	g
78 03 31 02	69	2	

12718 Flat scraper

for removing residues of sealant and adhesive.



Code	L mm	g	g
72 03 31 01	265	160	5

10356 Scraper

for removing residues of adhesive and stickers from vehicle glass.
Blade 40 mm wide, 0.3 mm thick, interchangeable with cover.



Code	Length mm	Width mm	g	g
74 27 00 05	165	40	90	1

10356R Spare blades

10 pieces



Code	g	g	g
79 27 00 15	45	1	

12749 Scraper with reversible tungsten steel blade

for removing residues of adhesive and stickers from vehicle glass.
Can also be used for scraping metal and seals.



Code	L mm	g	g
72 31 31 01	460	582	1

12749R Spare blade

for scraper No 12749.

Code	g	g	g
79 31 00 01	19	1	

10354 Tension strap with ratchet

for clamping and fixing freshly fitted vehicle glass, synthetic webbing.



Code	Width mm	Length mm	lifting power daN	g	g
74 27 00 03	25	4500	800	375	1

10355 Wire insert probe

for threading cutting wire through hardened adhesive, 2.5 mm steel tubing with brass handle.



Code	g	g	g
74 27 00 04	91	1	

Workshop sets

806/10 Tool set

99 Tools, in plastic inlays (modular system see page 42-52), 9x1/3 and 1x3/3 inlays for 4 drawers (No 98VA for 2 drawers), suitable for Workbench No WB620, Tool trolleys No 90, 95, 95VA, 98VA; Magazine case No 920 and Wheely box No 922N.

Code	kg
98 83 0001	13,35

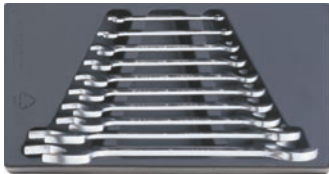

96 83 81 26



96 83 81 27



96 83 81 28

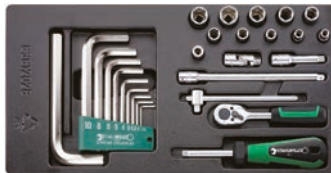

96 83 81 10



96 83 81 12



96 83 81 13



96 83 82 37



96 83 81 21



96 83 81 23



96 83 81 25

	No 10	sizes 6 x 7; 8 x 9; 10 x 11; 12 x 13; 14 x 15; 16 x 17; 18 x 19; 20 x 22; 24 x 27; 30 x 32 mm
	No 13	sizes 6; 7; 8; 9; 10; 11; 12; 13; 14; 15; 16; 17; 18; 19; 20; 21; 22; 24 mm
	No 40	1/4" sizes 5,5; 6; 7; 8; 9; 10; 11; 12; 13; 14 mm
	No 400	1/4" 150 mm
	No 404	1/4" 116 mm
	No 405/2	1/4" 54 mm
	No 405/6	1/4" 150 mm
	No 407	1/4" 38 mm
	No 412	1/4"

	No 415	1/4"
	No 10760CV	sizes 1.5; 2; 2.5; 3; 4; 5; 6; 8; 10; 12 mm
	No 52	1/2" sizes 10; 11; 12; 13; 14; 15; 16; 17; 18; 19; 20; 21; 22; 24; 27; 30; 32 mm
	No 506	1/2" 300 mm
	No 509/2	1/2" 52 mm
	No 509/5	1/2" 130 mm
	No 509/10	1/2" 255 mm
	No 510	1/2" 71 mm
	No 512	1/2"
	No 4620	size 1 (0.6 x 3.5 x 75 mm) size 2 (0.8 x 4.0 x 100 mm) size 3 (1.0 x 5.5 x 125 mm) size 4 (1.2 x 6.5 x 150 mm) size 5 (1.6 x 8.0 x 175 mm)
	No 4630	sizes 1; 2; 3
	No 65 01 5 180	
	No 65 29 5 200	
	No 65 43 4 002	
	No 65 45 4 002	
	No 65 51 6 240	
	No 65 64 2 250	
	No 66 02 5 160	
	No 102	175 mm
	No 108	150 x 6; 175 x 6 mm
	No 109	size 6; 100 x 3.4 mm
	No 10956	∅ 35 mm
	No 10960	500 g



806/10 Tool Set, suitable for example for Trolley 90 and 95.

Special automotive tools

806/9 TCS TCS tool set



98 Tools, in TCS inlays (Tool Control System see page 53-71), 7x1/3, 1x2/3 and 1x3/3 inlays for 4 drawers (No 98VA for 2 drawers), suitable for Workbench No WB620, Tool trolleys No 90, 95, 95VA, 98VA, Magazine case No 920 and Wheely box No 922N.

Code	kg
98830004	12.53



96838175

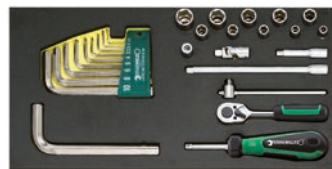

96838176



96838177



96838278



96838179



96838180



96838181



96838182

96838183

	No 10	sizes 6 x 7; 8 x 9; 10 x 11; 12 x 13; 14 x 15; 16 x 17; 18 x 19; 20 x 22; 24 x 27; 30 x 32 mm
	No 13	sizes 6; 7; 8; 9; 10; 11; 12; 13; 14; 15; 16; 17; 18; 19; 20; 21; 22; 24 mm
	No 40	1/4" \odot sizes 5.5; 6; 7; 8; 9; 10; 11; 12; 13; 14 mm
	No 400	1/4" ■ 150 mm
	No 404	1/4" ■ 116 mm
	No 405/2	1/4" ■ \odot 54 mm
	No 405/6	1/4" ■ \odot 150 mm
	No 407	1/4" ■ \odot 38 mm
	No 412	1/4" \odot \odot
	No 415	1/4" ■

	No 10760CV	sizes 1.5; 2; 2.5; 3; 4; 5; 6; 8; 10; 12 mm
	No 52	1/2" \odot sizes 10; 11; 12; 13; 14; 15; 16; 17; 18; 19; 20; 21; 22; 24; 27; 30; 32 mm
	No 506	1/2" ■ 300 mm
	No 509/2	1/2" ■ \odot 52 mm
	No 509/5	1/2" ■ \odot 130 mm
	No 509/10	1/2" ■ \odot 255 mm
	No 510	1/2" ■ \odot 71 mm
	No 512	1/2" ■
	No 4620	size 1 (0.6 x 3.5 x 75 mm) size 2 (0.8 x 4.0 x 100 mm) size 3 (1.0 x 5.5 x 125 mm) size 4 (1.2 x 6.5 x 150 mm)
	No 4630	sizes 1; 2; 3
	No 65 01 5 180	
	No 65 29 5 200	
	No 65 43 4 002	
	No 65 45 4 002	
	No 65 51 6 240	
	No 65 64 2 250	
	No 66 02 5 160	
	No 102	175 mm
	No 108	150 x 6; 175 x 6 mm
	No 109	size 6; 100 x 3.4 mm
	No 10956	\varnothing 35 mm
	No 10960	500 g

2500 TCS Workshop set for BMW vehicles



285 tools, in TCS inlays (Tool Control System see page 53-71), 7x1/3, 1x2/3 and 4x3/3 inlays for 7 drawers (No 98VA for 3.5 drawers).

Code	kg
97830600	23.7



96838192



96830679



96830605



96830602



96 83 06 03

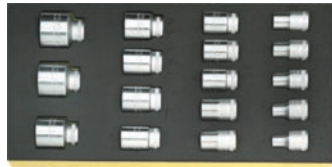

96 83 81 77

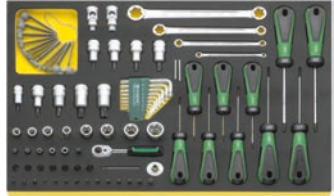

96 83 06 07



96 83 07 06

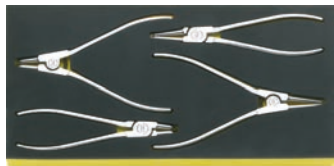

96 83 06 08

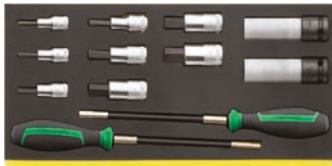

96 83 06 04

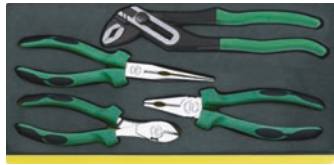

96 83 06 22





















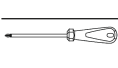









96 83 06 09

	No 10	sizes 6 x 7; 8 x 9; 10 x 11; 12 x 13; 14 x 15; 16 x 17; 18 x 19; 20 x 22; 21 x 24 mm
	No 13	sizes 6; 7; 8; 9; 10; 11; 12; 13; 14; 15; 16; 17; 18; 19; 21; 22; 24; 27; 30; 32 mm
	No 20	sizes 6 x 7; 8 x 9; 10 x 11; 12 x 13; 14 x 15; 16 x 17; 18 x 21; 19 x 22 mm
	No 24	size 10 x 11 mm
	No 40	1/4" \bigcirc sizes 3; 5; 5.5; 6; 7; 8; 9; 10; 11; 12; 13; 14 mm
	No 40L	1/4" \bigcirc sizes 4; 4.5; 5; 5.5; 6; 7; 8; 9; 10; 11; 12; 13 mm
	No 41K	1/4" \bigcirc \ominus 0.6 x 3.5; 1.0 x 5.5; 1.2 x 8 mm
	No 44K	1/4" \bigcirc \bullet 3; 4; 5; 6; 8 mm
	No 44P	1/4" \bigcirc \oplus sizes 1; 2; 3; 4 mm
	No 400	1/4" \blacksquare 150 mm
	No 404	1/4" \blacksquare 116 mm
	No 405/2	1/4" \blacksquare \bigcirc 54 mm
	No 405/4	1/4" \blacksquare \bigcirc 100 mm
	No 405/6	1/4" \blacksquare \bigcirc 150 mm
	No 407	1/4" \blacksquare \bigcirc 38 mm
	No 412	1/4" \bigcirc \bigcirc
	No 415	1/4" \blacksquare
	No 409	3/8" \blacksquare 1/4" \bigcirc
	No 456	3/8" \bigcirc sizes 7; 8; 9; 10; 11; 12; 13; 14; 15; 16; 17; 18; 19; 20; 21; 22 mm
	No 46	3/8" \bigcirc sizes 10; 11; 12; 13 mm
	No 47	3/8" \bigcirc sizes 10; 11; 12; 13; 14; 15; 16 mm
	No 49	3/8" \bigcirc sizes 5; 6; 7 mm
	No 1049-9	3/8" \bigcirc size 9 mm

	No 49X	3/8" \bigcirc sizes M6; M8; M10
	No 427/3	3/8" \blacksquare \bigcirc 76 mm
	No 427/5	3/8" \blacksquare \bigcirc 125 mm
	No 427/10	3/8" \blacksquare \bigcirc 240 mm
	No 435	3/8" \blacksquare
	No 452	3/8" \blacksquare
	No 428	3/8" \blacksquare \bigcirc 46 mm
	No 431	1/4" \blacksquare 3/8" \bigcirc
	No 432	1/2" \blacksquare 3/8" \bigcirc
	No 52	1/2" \bigcirc sizes 10; 11; 12; 13; 14; 15; 16; 17; 18; 19; 20; 21; 22; 24; 27; 30; 32 mm
	No 54	1/2" \bigcirc sizes 8; 10; 12; 14; 17 mm
	No 509QR/2	1/2" \blacksquare \bigcirc 52 mm
	No 509/5	1/2" \blacksquare \bigcirc 130 mm
	No 509QR/10	1/2" \blacksquare \bigcirc 255 mm (2x)
	No 506	1/2" \blacksquare 300 mm
	No 510	1/2" \blacksquare \bigcirc 71 mm
	No 512	1/2" \blacksquare
	No 513	3/8" \blacksquare 1/2" \bigcirc
	No 514	3/4" \blacksquare 1/2" \bigcirc
	No 2309K	1/2" \bigcirc sizes 17; 19 mm
	No 12506	sizes 6; 7 mm
	No 21TX	sizes E6 x E8; E10 x E12; E14 x E18; E20 x E24
	No 40TX	1/4" \bigcirc sizes E4; E5; E6; E7; E8
	No 44KTXB	1/4" \bigcirc sizes T10; T15; T20; T25; T27; T30; T40
	No 45TX	3/8" \bigcirc sizes E10; E12; E14
	No 47TX	3/8" \bigcirc sizes E8; E10
	No 49TX	3/8" \bigcirc size T40
	No 50TX	1/2" \bigcirc sizes E11; E16; E18; E20; E24
	No 54TX	1/2" \bigcirc sizes T45; T50; T55; T60
	No 54TXB	1/2" \bigcirc sizes T30; T40; T45; T50
	No 409M	3/8" \blacksquare 1/4" \bigcirc
	No 415B	1/4" \bigcirc
	No 1410	size T6
	No 1411	size T7
	No 1412	size T8
	No 1413	size T9
	No 1440	size T10
	No 1441	size T15
	No 1442	size T20
	No 1443	size T25
	No 1444	size T27
	No 1445	size T30
	No 1446	size T40
	No 1427	size T25 (65 mm)
	No 1435	size T55
	No PZ1221	size 1
	No PZ1222	size 2
	No PZ1223	size 3
	No 736/40	5/16" \bigcirc size D8
	No 3115/1	1/4" \blacksquare \bullet
	No 4856	sizes T6; T7; T8; T9; T10; T15; T20; T25; T27; T30
	No 10766	sizes T6; T7

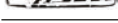
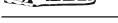
Continuation see next page

Special automotive tools

	No 10766/9	sizes T8; T9; T10; T15; T20; T25; T27; T30; T40
		TORX®-Lehre
	No 4628	size 1 (0.4 x 2.5 x 60 mm)
	No 4724	size 2 (1.0 x 5.5 x 25 mm)
	No 4734	size 2
	No 4744	size 1
	No 4820	0.6 x 3.5 x 75 mm 0.8 x 4.0 x 100 mm 1.2 x 6.5 x 150 mm 1.6 x 10.0 x 200 mm 2.0 x 12.0 x 250 mm
	No 4830	sizes 1; 2; 3
	No 4840	size 1
	No 10767/9	sizes 1.5; 2; 2.5; 3; 4; 5; 6; 8; 10 mm
	No 65 01 5 180	
	No 65 29 5 200	
	No 65 43 4 002	
	No 65 44 4 021	
	No 65 45 4 002	
	No 65 46 4 021	
	No 65 64 2 250	
	No 65 72 6 240	
	No 66 02 5 160	
	No 102	200 mm
	No 103	150 mm
	No 105	120 x 10 mm
	No 108	150 x 3; 150 x 4; 150 x 5; 150 x 6; 150 x 8 mm
	No 10957	∅ 40 mm
	No 10960	500 g
	No 12373	
	No 12600	500 g
	No 12718	
	No 12922E	
	No 12935/3	3 m
	No 39 Pkw	400 mm
	No 7756	

2501N TCS Workshop set for BMW motorbikes



215 tools, in TCS inlays (Tool Control System see page 53-71), 2x1/3, 2x2/3 and 5x3/3 inlays for 7 drawers (No 98VA for 3.5 drawers).

Code	kg
9783 06 06	23.3



96 83 20 96



96 83 20 95



96 83 20 97



96 83 20 98



96 83 20 99

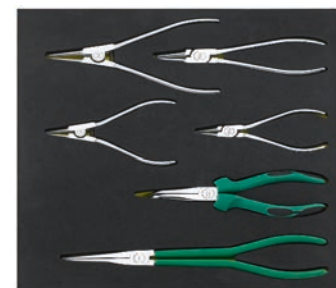

96 83 21 00









96 83 21 01



96 83 21 02



96 83 06 22

	No 10	sizes 6 x 7; 8 x 9; 10 x 11; 12 x 13; 14 x 15; 16 x 17; 18 x 19; 18 x 21; 20 x 22 mm
	No 13	sizes 5.5; 6; 7; 8; 9; 10; 11; 12; 13; 14; 15; 16; 17; 18; 19; 20; 21; 22; 23; 24; 27; 29; 30; 32; 34 mm
	No 40	1/4" ∅ sizes 4; 5; 5.5; 6; 7; 8; 9; 10; 11; 12; 13 mm
	No 44K	1/4" ∅ 3; 4; 5; 6; 8 mm
	No 400	1/4" ■ 150 mm
	No 404	1/4" ■ 116 mm

	No 405/2 No 405/4	1/4" ■ ○ 54 mm 1/4" ■ ○ 100 mm
	No 407	1/4" ■ ○ 38 mm
	No 412	1/4" ○ ○
	No 415	1/4" ■
	No 456	3/8" ○ sizes 8; 9; 10; 11; 12; 13; 14; 15; 16; 17; 18; 19; 20; 21; 22 mm
	No 46 No 4600 No 4606	3/8" ○ size 20.8 mm-13/16" 3/8" ○ size 16 mm-5/8" 3/8" ○ size 18 mm-11/16"
	No 49	3/8" ○ sizes 5; 6; 8 mm
	No 425	3/8" ■ 165 mm
	No 427/3	3/8" ■ ○ 76 mm
	No 427/10	3/8" ■ ○ 240 mm
	No 428	3/8" ■ ○ 46 mm
	No 431	1/4" ■ 3/8" ○
	No 432	1/2" ■ 3/8" ○
	No 435	3/8" ■
	No 52	1/2" ○ sizes 10; 11; 12; 13; 14; 15; 16; 17; 18; 19; 21; 22; 24; 27; 30; 32; 34 mm
	No 54	1/2" ○ sizes 10; 12 mm
	No 506	1/2" ■ 300 mm
	No 509/5	1/2" ■ ○ 130 mm
	No 509/10	1/2" ■ ○ 255 mm
	No 510	1/2" ■ ○ 71 mm
	No 512	1/2" ■
	No 513	3/8" ■ 1/2" ○
	No 21TX	sizes E6 x E8; E10 x E12
	No 40TX	1/4" ○ sizes E8; E10
	No 44KTXB	1/4" ○ sizes T8; T10; T15; T20; T25; T27; T30; T40
	No 45TX	3/8" ○ sizes E8; E10; E12; E14
	No 49TX No 54TX	3/8" ○ sizes T25; T45 1/2" ○ sizes T40; T50; T55; T60
	No 1054TX No 2054TX	1/2" ○ sizes T50; T55 1/2" ○ sizes T40; T45
	No 10771/8	sizes T9; T10; T15; T20; T25; T27; T30; T40
	No 10769	sizes T9; T10; T15; T20; T25; T30; T40; T45; T50
	No 4621	size 0 (0.4 x 2.5 x 80 mm) size 1 (0.5 x 3.5 x 90 mm) size 2 (0.6 x 4.0 x 100 mm) size 4 (1.0 x 6.5 x 140 mm) size 5 (1.2 x 8.0 x 160 mm)
	No 4631	sizes 1; 2
	No 4632	sizes 1; 2; 3
	No 4724	size 2 (1.0 x 5.5 x 25 mm)
	No 4734	size 2
	No 10506	0.8 x 4 x 300 mm
	No 10518	1.0 x 5.5 x 410 mm
	No 10767/9	sizes 1.5; 2; 2.5; 3; 4; 5; 6; 8; 10 mm
	No 10768	sizes 2.5; 3; 4; 5; 6; 8; 10 mm
	No 12507-2K	sizes 8; 10 mm
	No 65 01 5 180	

	No 65 29 5 200	
	No 65 34 5 280	
	No 65 35 5 200	
	No 65 43 4 001 No 65 43 4 002	
	No 65 45 4 001 No 65 45 4 002	
	No 65 72 6 240	
	No 66 02 5 160	
	No 102	150 mm
	No 103	150 mm
	No 105	120 x 10 mm
	No 108	150 x 2.5; 150 x 3; 150 x 4; 150 x 5; 150 x 6; 150 x 8 mm
	No 10356	
	No 10670	285 mm
	No 10672	20 x 315 mm
	No 10957	∅ 40 mm
	No 10960	300; 500 g
	No 12374	
	No 12600	500 g
	No 12900N	
	No 12922E	∅ 6 mm
	No 12965N	

Tool Control System

The safety inlay system

- Designed to fit our Tool Trolleys and Tool Boxes
- With yellow signal cut-outs to show whether all tools are in their places

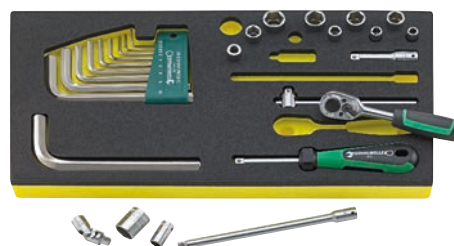

TCS

Special automotive tools

2502 TCS Workshop set for BMW motorbikes NEW



Entry-level set, 139 tools, in TCS inlay (Tool Control System see page 53-71), 3x3/3, 1x1/3 inlays for 4 drawers (No 98VA for 2 drawers).

Code	kg
97830607	12.4



96830180

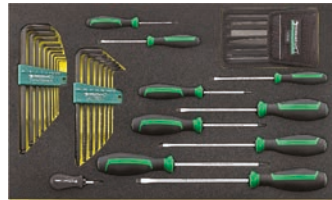

96830181



96833414



96830182

	No 13	sizes 6; 7; 8; 10; 11; 12; 13; 14; 15; 16; 17; 18; 19; 22; 24 mm
	No 17	sizes 8; 10; 13; 17; 19 mm
	No 40	sizes 5; 5.5; 6; 7; 8; 9; 10; 11; 12; 13 mm
	No 400N	1/4" ■ 150 mm
	No 405/2	1/4" ■ ○ 54 mm
	No 405/6	1/4" ■ ○ 150 mm
	No 407	1/4" ■ ○ 38 mm
	No 409	3/8" ■ 1/4" ○
	No 410	1/2" ■ 1/4" ○
	No 412	1/4" ○ ○
	No 415	1/4" ■
	No 431	1/4" ■ 3/8" ○
	No 432	1/2" ■ 3/8" ○
	No 52	1/2" ○ sizes 10; 11; 12; 13; 14; 15; 16; 17; 18; 19; 20; 21; 22; 24; 27; 30; 32 mm
	No 1054	1/2" ○ sizes 8; 10 mm
	No 2054	1/2" ○ sizes 5; 6 mm
	No 1054TX	1/2" ○ sizes T30; T50
	No 2054TX	1/2" ○ sizes T40; T45
	No 509/3	1/2" ■ ○ 75 mm
	No 509/5	1/2" ■ ○ 130 mm
	No 509/10	1/2" ■ ○ 255 mm
	No 510	1/2" ■ ○ 71 mm
	No 512	1/2" ■
	No 513	3/8" ■ 1/2" ○
	No 514	3/4" ■ 1/2" ○
	No 1204/21-1	4 x ⊕; 4x ⊕; 9 x ⊕; 3 x ⊕

	No 4620	size 1 (0.6 x 3.5 x 75 mm) size 2 (0.8 x 4.0 x 100 mm) size 3 (1.0 x 5.5 x 125 mm) size 4 (1.2 x 6.5 x 150 mm) size 5 (1.6 x 8.0 x 175 mm)
	No 4628	size 1 (0.4 x 2.5 x 60 mm)
	No 4630	sizes 1; 2; 3
	No 4734	size 2
	No 10767/9	sizes 1.5; 2; 2.5; 3; 4; 5; 6; 8; 10 mm
	No 10771/8	sizes T9; T10; T15; T20; T25; T27; T30; T40
	No 65 01 5 180	
	No 65 29 5 200	
	No 65 51 6 240	
	No 66 02 5 160	
	No 105-8/6K	No 105/120 x 10 mm No 108/150 x 2.5; 150 x 3; 150 x 4; 150 x 5; 150 x 6 mm
	No 10960	300 g
	No 12320	
	No 12800	
	No 12935/3	3 m

3026 TCS Tool set for Mercedes-Benz cars NEW



306 tools, in TCS inlay (Tool Control System see page 53-71), 4x1/3, 1x2/3 and 7x3/3 inlays for 9 drawers (No 98VA for 4.5 drawers).

Code	kg
97830208	37.5

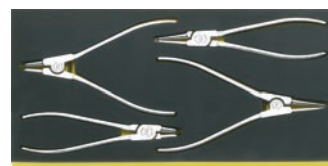

96830608



96831609



96830353

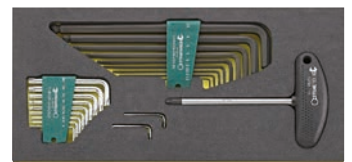

96833419



96833415



96833416



96 83 34 18



96 83 34 20

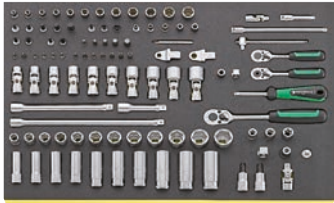

96 83 34 42



96 83 34 60



96 83 01 66

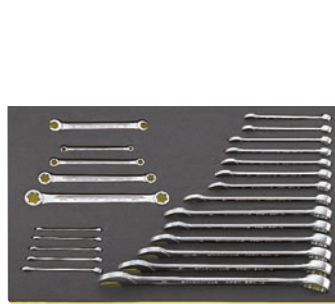















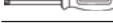

























96 83 34 17

	No 10	sizes 6 x 7; 8 x 9; 10 x 11; 12 x 13; 14 x 15; 16 x 17; 18 x 21; 19 x 22; 24 x 27; 30 x 32 mm
	No 13	sizes 6; 7; 8; 9; 10; 11; 12; 13; 14; 15; 16; 18; 19; 21; 22; 24; 27; 30; 32 mm
	No 17	sizes 8; 10; 12; 13; 17; 19 mm
	No 20	sizes 6 x 7; 8 x 9; 10 x 11; 12 x 13; 14 x 15; 16 x 17; 18 x 21; 19 x 22; 24 x 27; 30 x 32 mm
	No 24	size 10 x 11 mm
	No 40	1/4" \odot sizes 4; 5; 5.5; 6; 7; 8; 9; 10; 11; 12; 13; 14 mm
	No 41K	1/4" \odot \ominus 0.6 x 3.5; 1.0 x 5.5; 1.2 x 8 mm
	No 44K	1/4" \odot 3; 4; 5; 6; 8 mm
	No 44P	1/4" \odot \oplus sizes 1; 2
	No 44PZ	1/4" \odot \oplus sizes 1; 2
	No 400	1/4" \blacksquare 150 mm
	No 404	1/4" \blacksquare 116 mm
	No 405/2	1/4" \blacksquare \odot 54 mm
	No 405/6	1/4" \blacksquare \odot 150 mm
	No 407	1/4" \blacksquare \odot 38 mm
	No 409	3/8" \blacksquare 1/4" \odot
	No 412	1/4" \odot \odot
	No 415	1/4" \blacksquare
	No 415B	1/4" \odot
	No 456	3/8" \odot sizes 10; 11; 12; 13; 14; 15; 16; 17; 18; 19; 20; 21; 22 mm
	No 46	3/8" \odot sizes 10; 11; 12; 13; 14; 15; 16; 17; 18; 19 mm
	No 47	3/8" \odot sizes 10; 11; 12; 13; 14; 15; 16; 17; 18; 19 mm
	No 427/3	3/8" \blacksquare \odot 76 mm

	No 427/6	3/8" \blacksquare \odot 160 mm
	No 427/10	3/8" \blacksquare \odot 240 mm
	No 428	3/8" \blacksquare \odot 46 mm
	No 431	1/4" \blacksquare 3/8" \odot
	No 432	1/2" \blacksquare 3/8" \odot
	No 435	3/8" \blacksquare
	No 442	1/4" \odot 3/8" \odot
	No 50	1/2" \odot sizes 10; 11; 12; 13; 14; 15; 16; 17; 18; 19; 20; 21; 22; 23; 24; 26; 27; 28; 30; 32; 34 mm
	No 54	1/2" \odot sizes 5; 6; 7; 8; 10; 12; 14; 17; 19 mm
	No 54KK	1/2" \odot sizes 6; 7; 8; 10 mm
	No 50D IMP	1/2" \odot sizes 32; 36 mm
	No 2309K	1/2" \odot sizes 17; 19 mm
	No 54X	1/2" \odot sizes M8; M10; M12; M14; M16
	No 2054X/M8	1/2" \odot 120 mm
	No 2054X/M10	1/2" \odot 110 mm
	No 3054X/M12	1/2" \odot 140 mm
	No 3054X/M14	1/2" \odot 140 mm
	No 506	1/2" \blacksquare 300 mm
	No 509/5	1/2" \blacksquare \odot 130 mm
	No 509W/2	1/2" \blacksquare \odot 52 mm
	No 509W/5	1/2" \blacksquare \odot 130 mm
	No 509W/10	1/2" \blacksquare \odot 255 mm
	No 509QR/2	1/2" \blacksquare \odot 52 mm
	No 509QR/5	1/2" \blacksquare \odot 130 mm (2x)
	No 510	1/2" \blacksquare \odot 71 mm
	No 512	1/2" \blacksquare
	No 513	3/8" \blacksquare 1/2" \odot
	No 514	3/4" \blacksquare 1/2" \odot
	No 59X	3/4" \odot size M18
	No 556	3/4" \odot 320 mm
	No 558	510 mm
	No 21TX	sizes E6 x E8; E10 x E12; E14 x E18; E20 x E24
	No 40TX	1/4" \odot sizes E4; E5; E6; E7; E8
	No 45TX	3/8" \odot sizes E10; E12; E14
	No 49TX	3/8" \odot sizes T40; T45
	No 50TX	1/2" \odot sizes E11; E16; E18; E20; E24
	No 54TX	1/2" \odot sizes T50; T55; T60
	No 1350	size M4
	No 1356	size M5
	No 1357	size M6
	No 1358	size M8
	No 1359	size M10
	No 1410	size T6
	No 1411	size T7
	No 1412	size T8
	No 1413	size T9
	No 1440	size T10
	No 1441	size T15
	No 1442	size T20
	No 1443	size T25
	No 1444	size T27
	No 1445	size T30
	No 1446	size T40
	No 1427	size T25 (65 mm)
	No PZ1221	size 1
	No PZ1222	size 2

Continuation see next page

Special automotive tools

	No 4620	size 1 (0.6 x 3.5 x 75 mm) size 2 (0.8 x 4.0 x 100 mm) size 4 (1.2 x 6.5 x 150 mm)
	No 4621	size 1 (0.5 x 3.5 x 90 mm) size 5 (1.2 x 8.0 x 160 mm)
	No 4628	size 1 (0.4 x 2.5 x 60 mm)
	No 4630	sizes 1; 2; 3
	No 4650	sizes T6; T7; T8; T9; T10; T15; T20; T25; T27; T30
	No 4650L	sizes T15; T20; T25; T30
	No 4724	size 2 (1.0 x 5.5 x 25 mm)
	No 4734	size 2
	No 10766	sizes T6; T7
	No 10769	size T45
	No 10766/9	size T8; T9; T10; T15; T20; T25; T27; T30; T40
	No 10767H/9	sizes 1.5; 2; 2.5; 3; 4; 5; 6; 8; 10 mm
	No 736/10 No 736/10	1/4"  size  6.3 5/16"  size  8
	No 12506	sizes 6; 7; 8 mm
	No 12507-2K	sizes 8; 10; 13 mm
	No 65 01 5 180	
	No 65 29 5 145	
	No 65 43 4 002	
	No 65 44 4 021	
	No 65 45 4 002	
	No 65 46 4 021	
	No 65 51 6 240	
	No 66 00 5 145	
	No 66 02 5 180	
	No 66 02 5 200	
	No 65 64 2 250	
	No 39 Pkw	400 mm
	No 102	150; 200 mm
	No 105	120 x 10 mm
	No 108	150 x 3; 150 x 4; 150 x 5; 150 x 6; 150 x 8;
	No 10957	∅ 35 mm
	No 10960	500 g
	No 11006	400 mm
	No 11095/20	20 blades 0.05–1 mm
	No 12374	
	No 12600	3000 g
	No 12718	
	No 12900N	
	No 12900/3	
	No 12935/3	3 m

3022 TCS Tool set for Mercedes-Benz HGVs

NEW

TCS

264 tools, in TCS inlay (Tool Control System see page 53-71),
3x1/3, 1x2/3 and 8x3/3 inlays for 10 drawers (No 98VA for 5 drawers).

Code	⊕ kg
97 83 02 09	47.8



96 83 01 72

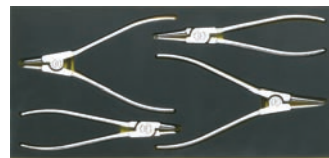

96 83 06 08



96 83 34 00



96 83 06 22



96 83 34 01



96 83 34 02



96 83 34 03



96 83 34 04



96 83 02 21



96 83 01 74

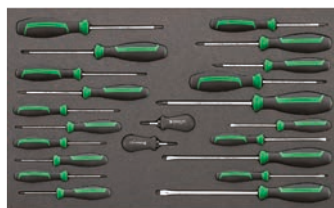

96 83 33 99

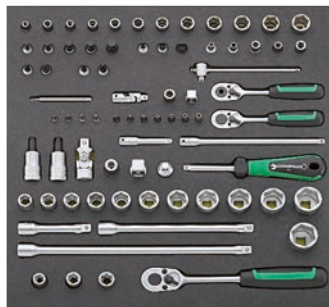













96 83 34 13

	No 10	sizes 6 x 7; 8 x 9; 10 x 11; 12 x 13; 14 x 15; 16 x 17; 18 x 21; 19 x 22; 24 x 27; 30 x 32; 34 x 36; 36 x 41 mm
	No 13	sizes 6; 7; 8; 9; 10; 11; 12; 13; 14; 15; 16; 17; 18; 19; 21; 22; 24; 27; 30; 32; 34 mm
	No 20	sizes 6 x 7; 8 x 9; 10 x 11; 12 x 13; 14 x 15; 16 x 17; 18 x 19; 20 x 22; 21 x 23; 24 x 26; 25 x 28; 27 x 32; 30 x 32; 36 x 41 mm
	No 40	1/4" sizes 4; 5; 5.5; 6; 7; 8; 9; 10; 11; 12; 13; 14 mm
	No 41K	1/4" 0.6 x 3.5; 1.0 x 5.5; 1.2 x 8 mm
	No 44K	1/4" 3; 4; 5; 6; 8 mm
	No 44P	1/4" size 1; 2
	No 44PZ	1/4" size 1; 2
	No 400	1/4" 150 mm
	No 404	1/4" 116 mm
	No 405/2	1/4" 54 mm
	No 405/6	1/4" 150 mm
	No 407	1/4" 38 mm
	No 409	3/8" 1/4"
	No 412	1/4"
	No 415	1/4"
	No 415B	1/4"
	No 456	3/8" sizes 10; 11; 12; 13; 14; 15; 16; 17; 18; 19; 21; 22 mm
	No 427/3	3/8" 76 mm
	No 427/6	3/8" 160 mm
	No 427/10	3/8" 240 mm
	No 428	3/8" 46 mm
	No 431	1/4" 3/8"
	No 432	1/2" 3/8"
	No 435	3/8"
	No 442	1/4" 3/8"
	No 50	1/2" sizes 10; 11; 12; 13; 14; 15; 16; 17; 18; 19; 20; 21; 22; 23; 24; 26; 27; 28; 30; 32; 34 mm
	No 54	1/2" sizes 5; 6; 7; 8; 10; 12; 14; 17; 19 mm
	No 51IMP	1/2" sizes 24; 27 mm
	No 2309 No 2309K	1/2" size 22 mm 1/2" sizes 17; 19 mm
	No 54X	1/2" sizes M6; M8; M10; M12; M14; M16
	No 509/2	1/2" 52 mm
	No 509/5	1/2" 130 mm
	No 509/10	1/2" 255 mm
	No 509W/2	1/2" 52 mm
	No 509W/5	1/2" 130 mm
	No 509W/10	1/2" 255 mm
	No 504/15	1/2" 397 mm
	No 506	1/2" 300 mm
	No 510	1/2" 71 mm
	No 512	1/2"
	No 513	3/8" 1/2"
	No 514	3/4" 1/2"

	No 55	3/4" sizes 22; 24; 27; 30; 32; 34; 36; 38; 41; 46; 50 mm
	No 552	3/4"
	No 556	3/4"
	No 559/8 No 559/16	3/4" 200 mm 3/4" 400 mm
	No 558	510 mm
	No 568	1/2" 3/4"
	No 21TX	sizes E6 x E8; E10 x E12; E14 x E18; E20 x E24
	No 40TX	1/4" sizes E4; E5; E6; E7; E8
	No 45TX	3/8" sizes E10; E12; E14
	No 49TX	3/8" sizes T40; T45
	No 50TX	1/2" sizes E11; E16; E18; E20; E24
	No 54TX	1/2" sizes T50; T55; T60
	No 1410	size T6
	No 1411	size T7
	No 1412	size T8
	No 1413	size T9
	No 1440	size T10
	No 1441	size T15
	No 1442	size T20
	No 1443	size T25
	No 1444	size T27
	No 1445	size T30
	No 1446	size T40
	No 1427	size T25 (65 mm)
	No 4620	size 1 (0.6 x 3.5 x 75 mm) size 2 (0.8 x 4.0 x 100 mm) size 4 (1.2 x 6.5 x 150 mm)
	No 4621	size 1 (0.5 x 3.5 x 90 mm) size 2 (1.2 x 8.0 x 160 mm)
	No 4630	sizes 1; 2; 3
	No 4640	sizes PZ1; PZ2
	No 4650	sizes T6; T7; T8; T9; T10; T15; T20; T25; T27; T30
	No 4724	size 2 (1.0 x 5.5 x 25 mm)
	No 4734	size 2
	No 10766	sizes T6; T7
	No 10767/9	sizes 1.5; 2; 2.5; 3; 4; 5; 6; 8; 10 mm
	No 10771/8	sizes T9; T10; T15; T20; T25; T27; T30; T40
	No 65 01 5 180	
	No 65 29 5 200	
	No 65 43 4 002	
	No 65 44 4 021	
	No 65 45 4 002	
	No 65 46 4 021	
	No 65 72 6 240	
	No 66 02 5 160	
	No 102	150; 200 mm
	No 105	120 x 12 mm
	No 108	150 x 3; 150 x 4; 150 x 5; 150 x 6; 150 x 8 mm
	No 10669	

Continuation see next page

Special automotive tools

	No 10957	∅ 50 mm
	No 10960	500; 1000 g
	No 12025	210 mm
	No 12030	260 mm
	No 12035	210 mm
	No 12036	260 mm
	No 12374	
	No 12600	3000 g
	No 12718	
	No 12900N	
	No 12900/3	
	No 12935/3	3 m

1100 TCS Tool set for Porsche



228 tools, in TCS inlays (Tool Control System see page 53-71), 1x1/3, 1x2/3 and 5x3/3 inlays for 6 drawers (No 98VA for 3 drawers).

Code	kg
97830411	24.7



96830192



96830193



96830194



96830195





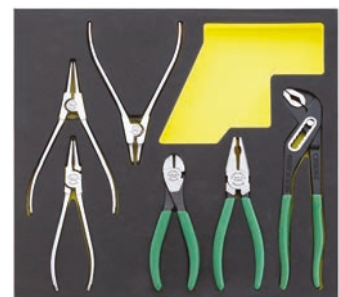



































96831196



96830197



96830198

	No 12	sizes 5.5; 12; 14 mm (2x)
	No 13	sizes 7; 11 mm (2x); sizes 6; 8; 9; 10; 12; 13; 14; 15; 16; 17; 18; 19; 20; 22; 24; 30; 32; 36 mm (1x)
	No 14	size 17 mm
	No 20	sizes 10 x 11; 12 x 13; 14 x 15; 17 x 19; 19 x 22 mm
	No 23	sizes 6 x 7; 8 x 9; 10 x 11; 12 x 13; 14 x 15; 16 x 17; 18 x 19; 20 x 22; 21 x 23; 24 x 27; 30 x 32 mm
	No 24	sizes 8 x 10; 11 x 13; 12 x 14; 17 x 19; 22 x 24 mm
	No 29	sizes 8 x 9; 10 x 11; 12 x 13; 14 x 15; 16 x 17; 18 x 19; 20 x 22 mm
	No 40	1/4" ∅ sizes 3.5; 4; 4.5; 5; 5.5; 6; 7; 8; 9; 10; 11; 12; 13 mm
	No 44	1/4" ∅ sizes 3; 4; 5; 6 mm
	No 400	1/4" ■ 150 mm
	No 404	1/4" ■ 116 mm
	No 405/6	1/4" ■ ∅ 150 mm
	No 407	1/4" ■ ∅ 38 mm
	No 409M	3/8" ■ 1/4" ∅
	No 415	1/4" ■
	No 45	3/8" ∅ sizes 8; 9; 10; 11; 12; 13; 14; 15; 16; 17; 18; 19 mm
	No 46	3/8" ∅ size 20.8 mm-13/16"
	No 49	3/8" ∅ sizes 4; 5; 6; 7; 8; 10 mm
	No 425	3/8" ■ 165 mm
	No 427/3	3/8" ■ ∅ 76 mm
	No 427/10	3/8" ■ ∅ 240 mm
	No 428	3/8" ■ ∅ 46 mm
	No 432M	1/2" ■ 3/8" ∅
	No 435	3/8" ■
	No 50	1/2" ∅ sizes 19; 21; 22; 24; 27; 30; 32 mm
	No 52	1/2" ∅ sizes 16; 17; 18; 19; 22; 24; 27; 30; 32 mm
	No 54	1/2" ∅ sizes 6; 7; 8; 10 mm
	No 54X	1/2" ∅ sizes M6; 8; 12; 14
	No 506	1/2" ■ 300 mm
	No 509/5	1/2" ■ ∅ 130 mm
	No 509/10	1/2" ■ ∅ 255 mm
	No 510	1/2" ■ ∅ 71 mm
	No 512	1/2" ■
	No 514M	3/4" ■ 1/2" ∅
	No 21TX	sizes E6 x E8; E10 x E12; E14 x E18; E20 x E24
	No 40TX	1/4" ∅ sizes E4; E5; E6; E7; E8
	No 45TX	3/8" ∅ sizes E10; E12; E14
	No 50TX	1/2" ∅ sizes E11; E16; E18; E20; E24
	No 54TX	1/2" ∅ sizes T45; T50; T55; T60

	No 1410	size T6
	No 1411	size T7
	No 1412	size T8
	No 1413	size T9
	No 1440	size T10
	No 1441	size T15
	No 1442	size T20
	No 1443	size T25
	No 1444	size T27
	No 1445	size T30
	No 1446	size T40
	No 1427	size T25 (65 mm)
	No 415SGB	1/4" \odot
	No 4650	sizes T6; T7; T8; T9; T10; T15; T20; T25; T27; T30
	No 10766/9	sizes T8; T9; T10; T15; T20; T25; T27; T30; T40
	No 4622	size 1 (1.0 x 5.5 x 100 mm) size 2 (1.2 x 6.5 x 125 mm) size 4 (1.6 x 10.0 x 175 mm) size 5 (2.0 x 12.0 x 200 mm)
	No 4630	size 1
	No 4632	size 3
	No 4724	size 2 (1.0 x 5.5 x 25 mm)
	No 4734	size 2
	No 10760CV/9	sizes 1.5; 2; 2.5; 3; 4; 5; 6; 8; 10 mm
	No 65 01 6 180	
	No 65 43 4 002	
	No 65 45 4 002	
	No 65 46 4 021	
	No 65 51 6 240	
	No 66 02 6 160	
	No 100	150 mm
	No 103	150 mm
	No 104	120 x 4; 120 x 6 mm
	No 105	120 x 12 mm
	No 108	150 x 4 mm
	No 10670	265 mm
	No 10940	\varnothing 55 mm
	No 10955	\varnothing 35 mm
	No 10960	300; 500 g
	No 11095/20	20 blades 0.05-1 mm
	No 12005	
	No 12036	260 mm
	No 12321	
	No 12905	
	No 12935/3	3 m

1120 TCS Workshop set for VW/Audi (basic)



241 tools, in TCS inlays (Tool Control System see page 53-71), 3x1/3, 3x2/3 and 4x3/3 inlays for 7 drawers (No 98VA for 4 drawers).

Code	\triangle kg
9783 08 20	30



9683 16 08



9683 16 15



9683 16 13



9683 15 85



9683 16 09



9683 08 77



9683 16 10



9683 01 66



9683 16 14























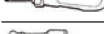



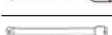

















































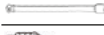





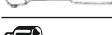







































9683 15 84

	No 13	sizes 6; 7; 8; 9; 10; 11; 12; 13; 14; 15; 16; 17; 18; 19; 21; 22; 24; 27; 30; 32 mm
	No 20	sizes 6 x 7; 8 x 9; 10 x 11; 12 x 13; 14 x 15; 16 x 17; 18 x 21; 19 x 22; 24 x 27; 30 x 32 mm
	No 24	size 10 x 11 mm
	No 17	sizes 8; 10; 12; 13; 17; 19 mm

Continuation see next page

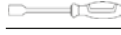
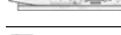
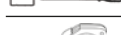
Special automotive tools

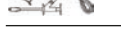
	No 40	1/4"  sizes 4; 5; 5.5; 6; 7; 8; 9; 10; 11; 12; 13; 14 mm	
	No 44K	1/2"  sizes 3; 4; 5; 6 mm	
	No 40TX	1/4"  sizes E4; E5; E6; E8	
	No 44KTX	1/4"  sizes T10; T15; T20; T25; T27	
	No 41K	1/4"  1.0 x 5.5 mm	
	No 44P	1/4"  sizes 1; 2	
	No 400	1/4"  150 mm	
	No 405W/2	1/4"   54 mm	
	No 405W/4	1/4"   100 mm	
	No 405W/6	1/4"   150 mm	
	No 407	1/4"   38 mm	
	No 412	1/4"  	
	No 415	1/4" 	
	No 409	3/8"  1/4" 	
	No 431	1/4"  3/8" 	
	No 432	1/2"  3/8" 	
	No 50	1/2"  sizes 8; 9; 10; 12; 13; 14; 15; 16; 17; 18; 19; 21; 22; 24; 27; 30; 32 mm	
	No 52	1/2"  sizes 10; 11; 12; 13; 14; 15; 16; 17; 18; 19; 20; 21; 22; 24; 27; 30; 32 mm	
	No 54	1/2"  sizes 5; 6; 7; 8; 10; 12; 14; 17; 19 mm	
	No 54KK	1/2"  sizes 5; 6; 7; 8; 10 mm	
	No 54X	1/2"  sizes M5; M6; M8; M10; M12; M14; M16	
	No 59X	3/4"  size M18	
	No 1054X/M8	1/2"  80 mm	
	No 3054X/M10	1/2"  140 mm	
	No 3054X/M12	1/2"  140 mm	
	No 3054X/M14	1/2"  140 mm	
	No 50TX	1/2"  sizes E10; E12; E14; E16; E18; E20	
	No 54TX	1/2"  sizes T25; T27; T30; T40; T45; T50; T55; T60	
	No 506	1/2"  300 mm	
	No 509W/2	1/2"   52 mm	
	No 509W/5	1/2"   130 mm	
	No 509W/10	1/2"   255 mm	
	No 510	1/2"   71 mm	
	No 512	1/2" 	
	No 513	3/8"  1/2" 	
	No 514	3/4"  1/2" 	
	No 556	3/4"  320 mm	
	No 558	510 mm	
	No 568	1/2"  3/4" 	
	No 2309K	1/2"  sizes 17; 19 mm	
	No 50D IMP	1/2"  sizes 32; 36 mm	
	No 1410	size T6	
	No 1411	size T7	
	No 1412	size T8	
	No 1413	size T9	
	No 4724	size 1 (0.6 x 3.5 x 25 mm)	
	No 4734	size 2	
	No 4620	size 1 (0.6 x 3.5 x 75 mm) size 2 (0.8 x 4.0 x 100 mm) size 3 (1.0 x 5.5 x 125 mm) size 4 (1.2 x 6.5 x 150 mm) size 5 (1.6 x 8.0 x 175 mm) size 6 (1.6 x 10.0 x 200 mm) size 7 (2.0 x 12.0 x 200 mm)	
	No 4632	size 1; 2; 3	
	No 4622SK	size 1 (0.8 x 4.0 x 90 mm) size 2 (1.0 x 5.5 x 100 mm) size 3 (1.2 x 6.5 x 125 mm)	
	No 4632SK	sizes 1; 2	
	No 4650	sizes T6; T7; T8; T9; T10; T15; T20; T25; T27; T30	
	No 10767/9	sizes 1.5; 2; 2.5; 3; 4; 5; 6; 8; 10 mm	
	No 10771/8	sizes T9; T10; T15; T20; T25; T27; T30; T40	
	No 65 01 5 180		
	No 65 29 5 160		
	No 65 43 4 002		
	No 65 44 4 021		
	No 65 45 4 002		
	No 65 46 4 021		
	No 65 63 2 250		
	No 65 72 6 240		
	No 66 02 5 180		
	No 102	150; 200 mm	
	No 105	120 x 10 mm	
	No 108	150 x 3; 150 x 4; 150 x 5; 150 x 6; 150 x 8 mm	
	No 10956	∅ 35 mm	
	No 10960	500 g	
	No 11095/13	0.05-1 mm	
	No 12320		
	No 12373		
	No 12600	500 g	
	No 12718		
	No 12900/3		
	No 12920N		
	No 12935/3	3 m	
	No 39 Pkw	400 mm	
	No 7756		

1120/1 TCS Additional set for VW

TCS

66 tools, in TCS inlays (Tool Control System see page 53-71), 2x1/3 und 1x2/3 inlays for 2 drawers (No 98VA for 1 drawer).

Code	Δ	kg
97 83 08 21		6.55



96 83 16 02



96 83 16 07



96 83 16 01

	No 10	sizes 6 x 7; 8 x 9; 10 x 11; 12 x 13; 14 x 15; 16 x 17; 18 x 21; 19 x 22; 24 x 27; 30 x 32 mm
	No 40DL	1/4" size 8 mm
	No 46	3/8" size 12 mm
	No 51	1/2" sizes 10; 13; 14; 15; 16; 17; 18; 19 mm
	No 54TX	1/2" sizes T30; T40; T45; T50; T55
	No 512	1/2"
	No 513	3/8" 1/2"
	No 1162	0.6 x 3.5 mm
	No 1164	0.8 x 4.0 mm
	No 1166	1.0 x 5.5 mm
	No 1166/1	1.2 x 6.5 mm
	No 1168	1.6 x 8.0 mm
	No 1299	2 mm
	No 1221	size 1
	No 1222	size 2
	No 1223	size 3
	No PZ1221	size 1
	No PZ1222	size 2
	No PZ1223	size 3
	No 1410	size T6
	No 1411	size T7
	No 1412	size T8
	No 1413	size T9
	No 1414	size T10
	No 1415	size T15
	No 1416	size T20
	No 1417	size T25
	No 1418	size T27
	No 1419	size T30
	No 1420	size T40
	No 1421	size T45
	No 1435	size T55

	No 1300	3 mm
	No 1301	4 mm
	No 1302	5 mm
	No 1303	6 mm
	No 1304	8 mm
	No 415B	1/4"
	No 12507-2K	sizes 8; 10; 13 mm
	No 65 01 5 180	
	No 65 29 5 145	
	No 65 30 5 200	
	No 66 00 5 145	
	No 66 02 5 200	

Tool Control System

The safety inlay system

- Designed to fit our Tool Trolleys and Tool Boxes
- With yellow signal cut-outs to show whether all tools are in their places

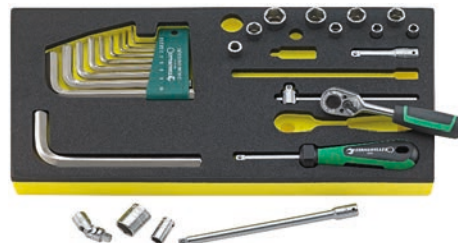

TCS

Special automotive tools

1120/2 TCS Additional set for Audi



73 tools, in TCS inlays (Tool Control System see page 53-71), 2x1/3, 1x2/3 and 1x3/3 inlays for 3 drawers (No 98VA for 1.5 drawers).

Code	kg
9783 08 22	8.04



9683 16 02



9683 16 03



9683 16 01



9683 16 95

	No 10	sizes 6 x 7; 8 x 9; 10 x 11; 12 x 13; 14 x 15; 16 x 17; 18 x 21; 19 x 22; 24 x 27; 30 x 32 mm
	No 456	3/8" \bigcirc sizes 10; 11; 12; 13; 14; 15; 16; 17; 18; 19; 21; 22 mm
	No 46	3/8" \bigcirc sizes 10; 11; 12; 13; 14; 15; 16; 17; 18; 19 mm
	No 47	3/8" \bigcirc sizes 10; 11; 12; 13; 14; 15; 16; 17; 18; 19 mm
	No 427/3	3/8" \blacksquare \bigcirc 76 mm
	No 427/6	3/8" \blacksquare \bigcirc 160 mm
	No 427/10	3/8" \blacksquare \bigcirc 240 mm
	No 427W/3	1/4" \blacksquare \bigcirc 76 mm
	No 427W/5	3/8" \blacksquare \bigcirc 125 mm
	No 427W/6	3/8" \blacksquare \bigcirc 160 mm
	No 428	3/8" \blacksquare \bigcirc 46 mm
	No 435	3/8" \blacksquare
	No 543	5/16" \bigcirc 1/2" \bigcirc
	No 1350	size M4
	No 1356	size M5
	No 1357	size M6
	No 1358	size M8
	No 1359	size M8
	No 4650L	sizes T15; T20; T25; T30
	No 736/10	1/4" \bigcirc size D 6.3
	No 736/10	5/16" \bigcirc size D 8
	No 12506	sizes 6; 7; 8 mm
	No 12507-2K	sizes 8; 10; 13 mm
	No 65 01 5 180	
	No 65 29 5 145	
	No 65 30 5 200	
	No 66 00 5 145	
	No 66 02 5 200	

1120/3 TCS Bodywork set for VW/Audi



9 tools, in TCS inlays (Tool Control System see page 53-71), 3/3 inlays for 1 drawer (No 98VA for 0.5 drawers).

Code	g
9683 15 86	4.4



9683 15 86

	No 112	240 mm
	No 65 63 2 175	
	No 65 64 2 145	
	No 65 64 2 250	
	No 10670	265 mm
	No 10960	200; 1000 g
	No 12752R	260 mm
	No 12752L	260 mm

Special tools for cars

Special tools for carburetors

10503 Screwdriver

for adjusting slotted screws, matt chrome, black tip.



Code	L mm	Blade mm	g	
7321 31 01	365	0.8 x 5.0 x 260	100	10

10506 Screwdriver

for setting correct CO-valve on mixture screen, idling mixture on Pierburg carburetors: BMW, Ford, Opel, Peugeot, Renault, Mercedes-Benz cars. Choke adjustment Audi 80, VW Passat 1.3-1.5; 1.6 l, matt chrome, black tip.



Code	L mm	Blade mm	g	
7301 00 01	350	0.8 x 4.0 x 300	53	10

10507N KK Ball ended hexagon driver

for hexagon socket head screws, size 3 mm, for mixture regulation on distributor of K-Jetronic: VW-Audi, Mercedes-Benz, Porsche 924, Ford and BMW, matt chrome, black tip.



Code	L mm	g	
7310 30 03	385	56	5

10518 Screwdriver

for adjustment (slotted screws), matt chrome, black tip.



Code	L mm	Blade mm	 g	
73 21 31 02	525	1,0 x 5,5 x 410	159	10

11085 Jet reamers

16 pieces in case
(0.33; 0.4; 0.45; 0.5; 0.6; 0.7; 0.75;
0.8; 0.9; 1.0; 1.1; 1.2; 1.4; 1.6; 1.8;
2.0 mm),
with holder.



Code	 g	
74 31 00 01	27	10

12504 Bit holder with inside hexagon

for all screwdriver bits,
flexible shaft, for adjustment.



Code	L mm	inside O"	Blade mm	 g	
18 10 30 16	290	1/4	150	168	10

54TX-T20 Screwdriver Bit

for inside TORX® screws, size T20,
1/2" -drive, use on mounting screws for
choke-switch on choke-flap L-Jetronic.



Code	Type	 g	
03 10 00 20	BMW	71	5

540-22 CROW-FOOT spanner

size 22 mm, 3/8" -drive,
on through-flow jet of 2B4-carburettor,
for use with adaptor No 513.



Code	Type	 g	
02 20 00 22	BMW: series 3, 518, 520	64	1

513 Adaptor

1/2" socket x 3/8" plug.



Code	Type	 g	
13 03 00 02	BMW: series 3, 518, 520	55	5

1062 Socket

bi-hexagon, AS-drive,
size 27 mm, 1/2" -drive,
for diesel injectors.



Code	Type	 g	
03 83 00 27	BMW: M 21: E30 = 324td, E28 = 524td, E34 = 524td, M 51: E36 = 325td, E34 = 525tds	255	5

1023 Special ring spanner

single ended, angled, size 13 mm,
use on mounting screws of injection
pump.



Code	Type	 g	
41 11 00 13	Citroën: all diesel VW/Audi: Audi 80 L, CL, GL, CD, Golf, Jetta, Caddy, Passat	67	1

51-27 Socket

extra deep, bi-hexagon, size 27 mm,
1/2" -drive, for injection nozzles on
diesel car engines.



Code	Type	 g	
03 02 00 27	Mercedes-Benz	294	5

51-30 Socket

size 30 mm, for injectors.

Code	Type	 g	
03 02 00 30	Mercedes-Benz	341	5

3000 Socket

multi-spline, 1.5 x 58 mm,
1/2" -drive,
for use on pre-chamber with
indirect injection.



Code	Type	 g	
03 39 00 01	Mercedes-Benz diesel	185	10

3505 Special extension



Code	Type	 g	
13 21 00 01		186	1

1054-13 INHEX socket

for hexagon socket head screws, size 13 mm,
length, 70 mm, 1/2" -drive,
for use on brass air-cooled injector nozzles.



Code	Type	 g	
03 15 07 13	VW/Audi: for engines with fuel injection	130	5

Special tools for valves and pistons

11063 Valve seating-ring pliers

for pulling valve stem seals and removal of valve spring base on VW-Audi engines with overhead camshaft i.e. Golf, Passat, Audi 80, Audi 100, BMW and Mercedes-Benz, bright nickel-plated.



Code	L mm	g	1
74 29 00 01	250	340	1

11063/1 Valve seating-ring pliers

for extracting poorly accessible valve shaft seals, e.g. in four-valve engines. Joint and jaws made of gun-finished hardened sheet steel. Handles made of nickel-plated shaped sheet steel.



Code	L mm	g	1
74 29 00 02	270	330	1

11068 Piston ring compressors

made of spring steel, stepless adjustment c/w hexagon key wrench.



Code	size	Clamp. width mm	Height mm	g	1
74 14 00 00	0	40-75	50	105	1
74 14 00 01	1¹⁾	57-125	80	230	1
74 14 00 03	2	90-175	80	270	1
74 14 00 05	3	90-175	165	603	1

¹⁾ Fiat-No A 60 605
(Type 126, 127, 128, X 1/9, 130, 131, 132, 850T, 238)

11069 Piston ring pliers

for mounting and removing piston rings, bright nickel-plated.



Code	size	for piston rings mm	L mm	g	1
74 15 20 01	1¹⁾	50-100	200	245	1
74 15 20 02	2	80-120	240	279	1
74 15 20 03	3	110-160	240	394	1
74 15 20 05	5²⁾	60-160	220	194	1

¹⁾ Fiat-No A 60 182 (Type 126, 127, 133, 850T)

²⁾ with V-shaped contact faces for safe and positive manipulation of piston rings

11095-11097 Precision feeler gauges

nickel-plated case, tapered blades.



Code	No	Sizes	L mm	g	1
74 24 00 01	11095/13	0.05; 0.10; 0.15; 0.20; 0.25; 0.30; 0.40; 0.50; 0.60; 0.70; 0.80; 0.90; 1.00 mm	100	61	10
74 24 00 02	11095/20	0.05; 0.10; 0.15; 0.20; 0.25; 0.30; 0.35; 0.40; 0.45; 0.50; 0.55; 0.60; 0.65; 0.70; 0.75; 0.80; 0.85; 0.90; 0.95; 1.00 mm	100	95	10
74 24 00 05	11097/26	1 1/2; 2; 2 1/2; 3; 4; 5; 6; 7; 8; 9; 10; 11; 12; 13; 14; 15; 16; 17; 18; 19; 20; 21; 22; 23; 24; 25/ 1000¹⁾	100	80	10

12108 Valve spring tool

incorporating 2 clamping and 2 compression facilities which are interchangeable, suitable for most car engines, some without removing cylinder head.



Code	g	1
74 57 00 01	780	1

12705 Motor mechanics stethoscope

steel probe, plastic handle and sound tubes.



Code	g	1
74 06 00 01	137	1

12731 Valve grinding tools

with suction cap.



Code	∅ mm	g	1
74 05 00 20	20	58	5
74 05 00 25	25	54	5
74 05 00 30	30	66	5
74 05 00 37	37	65	5

40-3 Socket

hexagon, size 3 mm, 1/4" O-drive, for releasing and tightening screws on the expansion valve.



Code	Type	g	1
01 01 00 03	BMW: X6 model E71, 7 Series model F01/F02	7	10

732/10-10 Ring insert tool

size 10 mm, valve adjustment, tightening torque 8-12 N·m.



Code	Type	g	g	g
58 22 10 10	BMW: all except Diesel	44	1	

1054-10 INHEX socket

for hexagon socket head screws, size 10 mm, length 140 mm, 1/2" drive, for cylinder head bolts.



Code	Type	g	g	g
03 15 14 10	Mercedes-Benz	150	5	

3054X-M10 Screwdriver BIT

for tri-square socket head screws (XZN®), size M10, length 140 mm, 1/2" drive, for cylinder head bolts and drive shaft bolts.



Code	Type	g	g	g
03 26 14 10	Mercedes-Benz	142	5	

3054X-M12 Screwdriver BIT

size M12, for cylinder head bolts, with tri-square socket head M12.



Code	Type	g	g	g
03 26 14 12	Mercedes-Benz	160	5	

3004 Screwdriver BIT

for tri-square socket head screws (XZN®), size M12, length 55 mm, 1/2" drive, for cylinder head bolts.



Code	Type	g	g	g
03 23 00 12	Mercedes-Benz	75	5	

54CV/9 Set: Screwdriver sockets

for spline socket head screws (Ribe-CV®), for brakes and cylinders head bolts.

Content: M5; M6; M7; M8; M9; M10; M12; M13; M14



Code	Type	g	g	g
96 03 19 01	Fiat, Alfa	1317	1	

54CV Screwdriver sockets

for spline socket head screws (Ribe-CV®), length 60 mm, 1/2" drive, for brakes and cylinder head bolts.



Code	size	Type	g	g
03 09 00 07	M7	Fiat	78	5
03 09 00 08	M8	Fiat	78	5
03 09 00 09	M9	Fiat (1,2 l; 8V/16V)	92	5
03 09 00 10	M10	Fiat (1,2 l; 8V/16V)	95	5
03 09 00 12	M12	Fiat (2,0 l)	119	5
03 09 00 13	M13	Fiat, Alfa (e.g. 1,6 l; 16V)	123	5
03 09 00 14	M14	Alfa (e.g. 1,6 l; 16V)	126	5
03 09 00 16	M16	Alfa (e.g. 1,6 l; 16V)	163	5

Special tools for chassies and steering

40TX-E8 Socket

for external TORX® screws, size E 8, 1/4" drive, for steering lock screws.



Code	Type	g	g	g
01 27 00 08	BMW	10	10	

24-17x19 OPEN-RING spanner

bi-hexagon, size 17 x 19 mm, use on wingpump manifold (hydro-steering).



Code	Type	g	g	g
41 08 17 19	BMW	151	10	

55-36 Socket

hexagon, size 36 mm, 3/4" drive, use on vibration damper.



Code	Type	g	g	g
05 01 00 36	BMW: series 5, 6 and 7, except 518-520i	386	2	

540-22 CROW-FOOT spanner

size 22 mm, 3/8" drive, use on track-rods.



Code	Type	g	g	g
02 20 00 22	BMW: series 3, 518, 520	64	1	

Special automotive tools

513 Adaptor

1/2" socket x 3/8" plug.



Code	Type	g	g	g
13030002	BMW: series 3, 518, 520	55	5	

1417 BIT

for inside TORX® screws, size T25; 1/4" drive, for screws on sun roof E30.



Code	Type	g	g	g
08130025	BMW	6	10	

3054X-M10 Screwdriver BIT

for tri-square socket head screws (XZN®), size M10, on drive shaft bolts.



Code	Type	g	g	g
03261410	Mercedes-Benz	142	5	

11060-3 Internal puller

capacity 27-36 mm, for taper roller bearing outer ring on steering housing, to be used with counter stay No 11061-2.



Code	Type	g	g	g
71160013	Mercedes-Benz	365	1	

11061-2 Counter stay with reduction unit

for taper roller bearing outer ring on steering housing.



Code	Type	g	g	g
71170012	Mercedes-Benz	1500	1	

46-19 Socket

Fiat-No A 57 052 extra deep, bi-hexagon, size 19 mm, 3/8" drive, for front mounting screw of top steering link on front wheel suspension.



Code	Type	g	g	g
02020019	Fiat: 1500, 125	112	10	

12495 Brass punch

Ø 20 mm, length 200 mm, for use on bushes bearing rings, steering pivot pin.



Code	Type	g	g	g
77130000	VW/Audi	533	5	

Special tools for ignition and electrics

3466 Spark plug socket

3/8" drive, with magnet, outside dia 25.5 mm, for deep seated plugs.



Code	mm/"	L mm	g	g
02140036	16-5/8	85	198	5

4600 Spark plug socket

3/8" drive, with rubber insert.



Code	mm/"	L mm	g	g
02120036	16-5/8	60	88	10

4606 Spark plug socket

3/8" drive, with rubber insert.



Code	mm/"	L mm	g	g
02130018	18-11/16	65	132	10

46 Spark plug socket

3/8" drive, with rubber insert.



Code	mm/"	L mm	g	g
02020208	20,8-13/16	65	151	10

51 Spark plug socket

1/2" drive, with rubber insert.



Code	mm/"	L mm	g	g
03020216	16-5/8	83	137	10
03020208	20,8-13/16	83	194	10

51S Spark plug socket

1/2" \odot -drive, with rubber insert.



Code	\odot mm/"	L mm	\triangle g	
03 24 02 08	20,8-13/16	83	196	10

5100 Rubber insert

for size 20.8 mm
(No 46; 51; 51S).



Code	\triangle g	
09 01 00 01	5	5

10626 Spark plug connector pliers

forged, with 45° offset, curved jaws,
for extracting and replacing
sparkplug connectors.



Code	L mm	\triangle g	
76 53 00 01	195	223	1

12375 Spark plug brush

wood, brass wire dia 0.15 mm.



Code	L mm	Reihen	\triangle g	
74 16 00 01	150	3 x 5	18	10

Tools for heater plugs

25GK Ratchet ring spanner

angled, extra long,
for hard-to-reach heater plugs
(e.g. BMW, Mercedes-Benz, Peugeot,
Renault, Seat, VW/Audi), size 8 mm for contact rail bolts,
size 12 mm for diesel heater plugs, chrome plated.



Code	\odot mm	L mm	\triangle g	
41 18 08 12	8 x 12	255	156	1

3047 Spark plug sockets

extra long,
for hard-to-reach heater plugs,
3/8" \odot -drive, size 10 mm e.g. for
Renault, VW/Audi TDi;
size 12 mm e.g. for BMW,
Mercedes-Benz (201, 202 four-valve technology), Ford, Opel, Renault.



Code	\odot mm	L mm	\triangle g	
02 18 00 10	10	140	138	1
02 18 00 12	12	140	138	1

46-12 Socket

extra deep, bi-hexagon, size 12 mm,
3/8" \odot -drive, use on glow plugs of diesel
engines.



Code	Type	\triangle g	
02 02 00 12	BMW: 324d; 524d	57	10

Testing tools for car electrics

12905 Car circuit tester

for car electrics 6-12 volt and
24 volt, with pointed probe,
cover cap, connecting lead with
alligator clip.



Code	L mm	\triangle g	
77 38 00 01	120	73	10

7756 Automotive voltage tester (complete set)

Testing unit for electric and
electronic car components,
3-48 volt, 4 LEDs to indicate
voltage and plus or minus pole,
complete in Pc-bag.

Content:

- 1 basic unit with 1.5 m cable,
- testing tip, integrated mechanical sliding needle,
- 1 crocodile terminal,
- 1 jaw clamp.



Code	\triangle g	
77 56 00 02	85	1

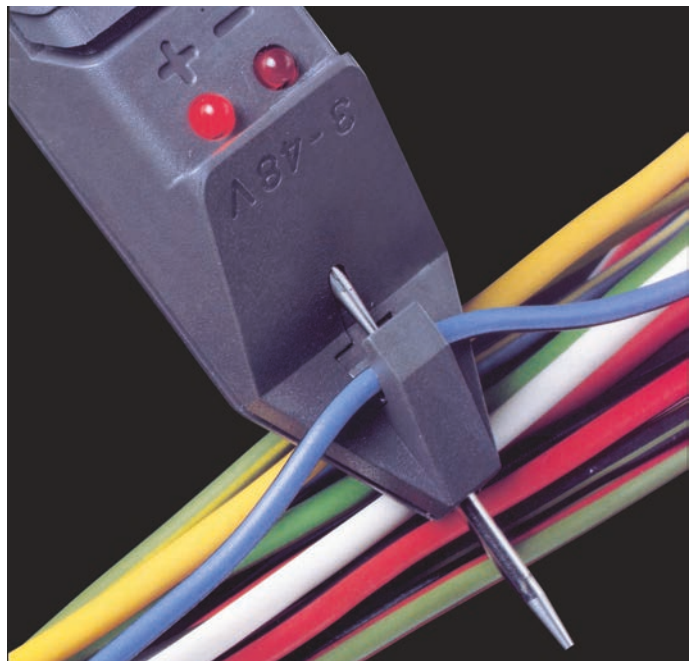

Special tools for brakes and wheels

ES 721/15/3/2



530 x 350 x 40 mm, 6 pieces

Code	No	Dimensions / Description	Weight (g)
96838172			5012
	No 2309K	1/2" O sizes 17; 19; 21 mm	
	No 721/15 Quick	30-150 N-m	
	No 35c Pkw	17; 19; 22; 1/2"	
	No 10599/2	245 mm	
83812087	Empty tray		299

34c/35c Wheel braces

DIN 3119/ISO 6788, forged centre section, pressed-in extension arms with extra deep forged socket heads, Chrome Alloy Steel, chrome plated.



Code	No	O mm/"	L mm	Weight (g)	Box
43030006	35c Pkw	17; 19; 22; 1/2"	400	2058	1
43030005	34c Lkw	24; 27; 32; 3/4"	700	5053	1

39 Tyre levers

Handy, sturdy construction, purposefully shaped, Chrome Alloy Steel.



Code	No	L mm	Weight (g)	Box
74010400	39 cars	400	383	5
74010600	39/1 HGVs	600	897	5
74010602	39/2 HGVs	600	1172	5
74010603	39/3 HGVs	600	915	5

51S Socket



extra deep, DIN 3124/ISO 2725-1, E DIN EN 3710, E DIN EN 3709 (test loads), with rubber insert for spark plugs and for tightening and untightening wheel nuts on Japanese cars, HPQ® high performance steel, chrome plated.

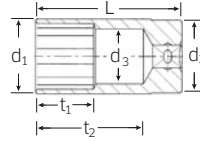

Code	O mm/"	d1 mm	d2 mm	d3 mm	L mm	t1 mm	t2 mm	Weight (g)	Box
03240208	20.8-13/16	27.7	26	20	83	22	66.2	196	10

2309 IMPACT sockets

1/2" O-drive, for power drivers, extra deep, with reduced outside diameter, Chrome Alloy Steel, gunmetal finish.

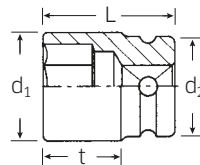

Code	O mm	d1 mm	d2 mm	L mm	t mm	Weight (g)	Box
23090017	17	25.7	30	85	68	242	5
23090019	19	28.2	30	85	67.5	257	5
23090221	NEW 21	30.7	30	85	66.5	272	5
23090022	22	32	30	85	66.5	311	5

for wheel nuts

2309K Wheel nut sockets

with plastic sleeve. Sleeve extension protects not only wheel bolts and nuts but also the wheel and holes.



Code	O mm	O "	L mm	Ø mm	Weight (g)	Box
23091017	17	1/2	86	27	242	1
23091019	19	1/2	86	29	250	1
23091221	NEW 21	1/2	86	31	265	1

10599/2 Balance weight pliers

with cutter for cutting and trimming lead weights (with or without adhesive foil), Chrome Vanadium, chrome plated.



Code	L mm	Weight (g)	Box
76294003	245	319	1

10613 Brake spring pliers

for rivetted brake linings/shoes, Chrome Vanadium, bright nickel-plated.



Code	L mm	g	
76 41 3001	210	245	6

10613/1 Brake spring pliers

with flexible anvil, for rivetted and glued brake linings/shoes.



Code	L mm	g	
76 41 3021	330	461	2

12371 Brake calliper file

for removing dust, rust and dirt from brake calliper groove.



Code	L mm	g	
74 54 31 01	260	104	5

12373 Steel wire brush

special slim design.



Code	L mm	Rows	g	
77 44 0001	230	2	70	10

12900/3 Tyre tread Vernier calliper

- sturdy brass construction
- smooth ground surface



Code	measuring range mm	g	
77 37 1004	30	42	1

12900/4 Electronic tyre tread Vernier calliper

- large LCD display with clear read-offs, figures 9.5 mm high
- display accuracy 0.01 mm/0.0005"
- ON/OFF push button
- unit of measure switchable mm/inch
- zeroing possible in any position
- incl. 1 x 3 V battery (type CR2032) packed in accordance with UN3091, Class 9



Code	measuring range mm/"	g	
77 37 1005	25/1	40	1

54-7 INHEX socket

for hexagon socket head screws, size 7 mm, 1/2" O-drive, for changing brake linings.



Code	Type	g	
03 05 00 07	BMW: 518, 520i, 525i, 528i	75	5

1049-9 INHEX socket

for hexagon socket head screws, size 9 mm, 3/8" O-drive, for brake calliper retainers.



Code	Type	g	
02 15 10 09	BMW, MINI	62	5

733/10-11 OPEN-RING insert tool

size 11 mm, use with SERVICE-MANOSKOP® torque wrench No 730/5, for flare nuts on brake lines and bleed screws.



Code	Type	g	
58 23 10 11	Mercedes-Benz	55	1

733/10-12 OPEN-RING insert tool

size 12 mm, for flare nuts on brake pressure regulator, tightening torque 15-18 N-m.



Code	Type	g	
58 23 10 12	BMW	59	1

733/10-14 OPEN-RING insert tool

size 14 mm, for flare nuts on main brake cylinder, tightening torque 16-25 N-m (BMW), for flare nuts on brake lines and bleed screws (Mercedes-Benz).

Code	Type	g	
58 23 10 14	BMW, Mercedes-Benz	60	1

733/10-17 OPEN-RING insert tool

size 17 mm, for flare nuts on main brake cylinder, tightening torque 16-25 N-m.

Code	Type	g	
58 23 10 17	BMW	64	1

733/10-19 OPEN-RING insert tool

size 19 mm, for flare nuts on main brake regulator, tightening torque 30-40 N-m.

Code	Type	g	
58 23 10 19	BMW	80	1

Special automotive tools

54CV/9 Set: Screwdriver sockets

for spline socket head screws (Ribe-CV®), for brakes and cylinders head bolts.
Content:
M5; M6; M7; M8; M9; M10; M12; M13; M14



Code	Type	g	g	g
96 03 19 01	Fiat, Alfa	1317	1	

54CV Screwdriver sockets

for spline socket head screws (Ribe-CV®), length 60 mm, 1/2" O-drive, for brakes and cylinder head bolts.



Code	size	Type	g	g
03 09 00 07	M7	Fiat	78	5
03 09 00 09	M9	Fiat (1,2 l; 8V/16V)	92	5
03 09 00 13	M13	Fiat, Alfa (e.g. 1,6 l; 16V)	123	5

3045K Special sockets

for oil filters, size 74 mm, 14-point, 10 mm dia. bore and outside hexagon 22 mm Ø, extremely compact – essential where access is awkward.



Code	total height mm	Type	g	g
74 37 00 03	44	e.g. Ford Mondeo from 02/2002	104	1

3046 Special sockets

for fitting and removing oil filter covers when changing oil filter cartridges.



Code	mm	"	Type	g	g
02 11 10 32	32	3/8	e.g. Audi, MAN, Vauxhall Astra, Corsa, VW Passat	130	1
02 11 10 36	36	3/8	e.g. BMW, Mercedes-Benz cars, 100 D Transporter, MAN, Vauxhall Vectra B DI 16V, VW Lupo 1.2 TDi, model year 99	171	1

Special tools for lubrication service

1015 Oil filter claw

for loosening of oil filters on cars.



Code	Clamp. width mm	total height mm	length of claws mm	g	g
74 62 00 02	3/8 68-120	65	50	530	1

3045 Special socket

for oil filters, size 74 mm, 14-point, 10 mm dia. bore and outside hexagon 22 mm Ø.



Code	total height mm	g	g
74 37 00 01	52	131	1

12005 Strap wrenches

for oil filters etc., up to 180 mm diameter, non-slip rubber cloth tape, 22 mm width.



Code	No	L mm	g	g
76 50 00 01	12005	236	264	1
79 15 00 01	12005/1 ¹⁾	600	68	1

¹⁾ spare strap

12007 Oil filter wrenches

adjustable for diameters 80-110 mm. Hardened anti-slip cams ensure safety during use.



Code	No	L mm	g	g
76 52 10 01	12007/1 ¹⁾	150	226	1
76 52 10 02	12007/2 ²⁾	240	319	1

¹⁾ with 1/2" O

²⁾ with lever handle

54-14 INHEX socket

for hexagon socket head screws, size 14 mm, 1/2" O-drive, for use on oil drain plug.



Code	Type	g	5
03 05 00 14	Mercedes-Benz	135	5

10765-12 Hexagon key wrench

Fiat-No A 5013 long, for hexagon socket head screws, size 12 mm, for oil drain plug on engine, gearbox and rear axle.



Code	Type	g	5
43 21 00 12	Fiat	287	5

1054-13 INHEX socket

for hexagon socket head screws, size 13 mm, length 70 mm, 1/2" O-drive, for oil drain plug on engine.



Code	Type	g	5
03 15 07 13	Lancia	130	5

1058 Oil service spanner

bent, size 8 and 10 mm outside square, for drain plugs on sump, gearbox, differential.



Code	Type	g	5
44 73 08 10	Peugeot, Renault	314	5

1054KK-5 INHEX socket

with ball-point hexagon, size 5 mm, length 238 mm, 1/2" O-drive, for use on socket head screws with difficult access up to an angle of 25°, size 5 mm for use on sump screws of 5 cylinder diesel engine, van T4.



Code	Type	g	5
03 31 00 05	VW/Audi	145	5

1054KK-8 INHEX socket

size 8 mm, length 238 mm.



Code	Type	g	5
03 31 00 08	VW/Audi	154	5

Special tools for engine and gear transmission

50TX-E10 Socket

for external TORX® screws, size E10, 1/2" O-drive, use on mounting screws for GETRAG 260 gearbox, as well as on automatic gearboxes fitted to US and Japanese models.



Code	Type	g	10
03 27 00 10	BMW	53	10

50TX-E12 Socket

size E12

Code	Type	g	10
03 27 00 12	BMW	55	10

50TX-E14 Socket

size E14

Code	Type	g	10
03 27 00 14	BMW	56	10

54TX-T27 Screwdriver BIT

for inside TORX® screws, size T27, 1/2" O-drive, use on switchgear of automatic gearbox 3HP 22, 4HP 22



Code	Type	g	5
03 10 00 27	BMW	72	5

1418 BIT

for inside TORX® screws, size T27, 1/4" O-drive, use on switchgear on automatic gearbox 3HP 22, 4HP 22.



Code	Type	g	10
08 13 00 27	BMW	6	10

Special automotive tools

730N/5 SERVICE-MANOSKOP® torque wrench

10–50 N-m, with tool carrier for insert tools, for tightening ZF switch-gear and adjustment brake belt BW 65 on automatic gearbox, to use with ratchet insert tool No 735/10.



Code	Type		
50 18 10 05	BMW	831	1

735/10 Ratchet insert tool

reversible, 1/2" -drive.





Code		
58 25 00 10	147	1

6547 Special circlip pliers

use on retaining ring on gearbox main shaft (all "GETRAG" and ZF gearboxes S4-18/3).



Code	Type		
65 47 41 70	BMW	154	1

3049-8 INHEX socket

for hexagon socket head screws, size 8 mm, length 24 mm, 3/8" -drive, for use on mounting screws on fluid fly-wheel.



Code	Type		
02 15 24 08	Mercedes-Benz	28	5

51-27 Socket

extra deep, bi-hexagon, size 27 mm, 1/2" -drive, for rotating engine through hexagon on crankshaft.



Code	Type		
03 02 00 27	Mercedes-Benz	294	5

1054-10 INHEX socket

for hexagon socket head screws, size 10 mm, length 140 mm, 1/2" -drive for bolts on car engines.



Code	Type		
03 15 14 10	Mercedes-Benz	150	5

11060-1a Internal puller

capacity 16–20 mm, for sealing ring and bearing on crankshaft, use with counter stay No 11061-1.



Code	Type		
71 16 00 21	Mercedes-Benz	120	1

11061-1 Counter stay



Code		
71 17 00 11	654	1

11060-2 Internal puller

capacity 20–27 mm, for bearing bush of idler gear on oil pump drive, use with counter stay No 11061-2.



Code	Type		
71 16 00 12	Mercedes-Benz	131	1

11061-2 Counter stay



Code		
71 17 00 12	1500	1

730/2 SERVICE-MANOSKOP® torque wrench

capacity 4–20 N-m.



Code	Type		
50 18 00 02	VW/Audi	315	1

734/5 Square drive insert tool

3/8" -drive, for use with SERVICE-MANOSKOP® torque wrench No 730/2.



Code	Type		
58 24 00 05	VW/Audi	76	1

12717 Pin wrench
 offset, distance between pins 18 mm, pin dia. \varnothing 2.9 mm, length 140 mm, for ring nut of tension pulley on 1.6 l diesel.



Code	Type		
		g	
44 70 00 18	2/80 Golf, Jetta, Passat, Audi 80	75	10

Special tools miscellaneous

157 Chain exhaust-pipe cutter
 infinitely adjustable, with twist handle, also suitable for special steel pipes up to 1.8 mm wall thickness, chain length 270 mm.



Code	mm		
		g	
60 11 00 01	25-75	705	1

K157 Chain

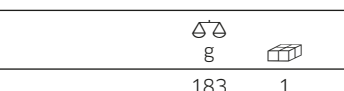

Code		
	g	
69 13 00 01	183	1

1225 Special extension
 offset, for use on magnetic switch diesel pump.



Code	"		
		g	
12 25 00 01	$\frac{3}{8}$	128	5

10614 Hose clip pliers
 for self tightening hose clips, nickel-plated.



Code	L mm		
		g	
76 46 00 00	220	293	1

10615/1 Hose clip pliers CLIC
 for CLIC hose clips e.g. Alfa Romeo, Audi, BMW, Opel, Peugeot, VW. Work can be carried out at various angles due to stepless swivelling jaws.



Code	L mm		
		g	
76 46 00 13	200	189	1

10623/1 Hose clip pliers
 registered design, with rotating jaws and multiple locking positions, single-handed use even with wide openings due to variable-geometry joint, especially for 12 and 15 mm wide, large-format hose clips, e.g. for Alfa Romeo, Audi, Citroën, Fiat, Ford, Mercedes-Benz, Opel, Peugeot, Porsche, Renault, VW.



Code	L mm		
		g	
76 46 00 12	290	414	1

10623/2 Hose clip pliers
 registered design, with Bowden cable and multiple locking positions, especially for 12 and 15 mm spring-steel hose clips, suitable for use near cooling and heating systems up to a diameter of 42 mm, access to hard-to-reach places using Bowden cable remote action (length 610 mm), e.g. for Alfa Romeo, Audi, Citroën, Fiat, Ford, Mercedes-Benz, Opel, Peugeot, Porsche, Renault, VW.



Code	L mm		
		g	
76 54 00 01	300	565	1

Replacement Bowden cable for No 10623/2

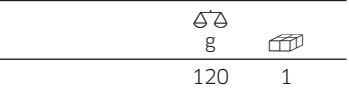

Code		
	g	
79 54 00 01	120	1

10625 Ear clamp pincers
 for application of 1 and 2-ear clamps on shaft sleeves, radiator and fuel lines e.g. for Audi, BMW, Ford, GM, Honda, Mazda, Mercedes-Benz, Nissan, Opel, VW, quality steel, black paint finish.



Code	L mm		
		g	
76 54 00 02	225	340	1

10625/2 Hose clip pliers
 for correctly closing hose clips without ears, for shaft sleeves on Audi, Mercedes-Benz, Toyota and VW. Quality steel, nickel-plated, jaws gunmetal finished.



Code	L mm		
		g	
76 54 00 03	200	173	1

12718 Flat scraper
 special steel, for removal of gasket seals on carburettor, valve cover, cylinder head etc.



Code	L mm		
		g	
72 03 31 01	265	160	5



Special automotive tools

12763 Pull hook for rubber exhaust mountings

with T-bar, chromium-plated, black dip-coated, for pulling rubber loops on exhaust mountings. All cars except Ford.



Code	L mm	g	g	g
74 20 00 02	210	100	5	

12771 Extractor pliers

for removing fixing plugs on door trims, outside trims, rubber bumper covers etc. Joint and jaws made of hardened sheet steel, handles made of shaped sheet steel.



Code	L mm	g	g	g
76 48 00 01	230	182	1	

12975 Fuel hose clamp

capacity up to Ø 20 mm, for stopping fuel flow temporarily.



Code	g	g	g
74 34 00 01	38	10	

1435 BIT

for inside TORX® screws, size T55, 5/16" drive, for screws in rear seats, for use with bit-holder insert tool No 736/40.



Code	Type	g	g	g
08 14 00 55	BMW: X6 model E71, series 7 model F01/F02	20	10	

736/40 BIT holder insert tool

Internal hex drive 5/16", for screws in rear seats, for use with bit No 1435.



Code	Type	g	g	g
58 26 10 40	BMW: X6 model E71, series 7 model F01/F02	112	1	

1445 BIT

for inside TORX® tamper resistant screws, size T30, 1/4" drive, use on sensor screws wheelhouse (models with airbag system).



Code	Type	g	g	g
08 16 00 30	BMW	6	10	

12506-6 Hexagon nut spinner

flexible, size 6 mm, for screws on hose clips of radiator hose, max. tightening torque 8 N·m.



Code	Type	g	g	g
43 10 32 06	BMW	167	10	

440-17 CROW-RING spanner

size 17 mm, 3/8" drive, for use on pipes for air conditioning unit.



Code	Type	g	g	g
02 19 00 17	Mercedes-Benz	40	1	

440-19 CROW-RING spanner

size 19 mm.

Code	g	g	g
02 19 00 19	40	1	

440-22 CROW-RING spanner

size 22 mm.

Code	g	g	g
02 19 00 22	57	1	

440-24 CROW-RING spanner

size 24 mm.

Code	g	g	g
02 19 00 24	57	1	

735/20 Ratchet insert tool

reversible, 1/2" drive, use with SERVICE-MANOSKOP® torque wrench No 730/12 and 730/20, for general service work.



Code	Type	g	g	g
58 25 00 20	Mercedes-Benz	302	1	

730R/5 Quick SERVICE-MANOSKOP® torque wrench

capacity 6–50 N·m, 3/8" ■-drive, for general service work.



Code	Type		
96 50 40 05	Mercedes-Benz	g 945	1

730R/12 Quick SERVICE-MANOSKOP® torque wrench

25–130 N·m, 1/2" ■-drive



Code	Type		
96 50 40 12	Mercedes-Benz	g 1410	1

730R/20 Quick SERVICE-MANOSKOP® torque wrench

40–200 N·m, 1/2" ■-drive.



Code	Type		
96 50 40 20	Mercedes-Benz	g 1555	1

11060-1 Internal puller

Spannweite 12–16 mm, zum Ausziehen von Kugellagern, Dichtringen, Verschlussringen, Lagerbuchsen usw.



Code	Type		
71 16 10 11	Mercedes-Benz	g 110	1

11060-2 Internal puller

capacity 20–27 mm.

Code	Type		
71 16 00 12	Mercedes-Benz	g 131	1

11060-3 Internal puller

capacity 27–36 mm.

Code	Type		
71 16 00 13	Mercedes-Benz	g 365	1

11060-5 Internal puller

capacity 36–46 mm.

Code	Type		
71 16 00 15	Mercedes-Benz	g 385	1

11060-6 Internal puller

capacity 46–58 mm.

Code	Type		
71 16 00 16	Mercedes-Benz	g 558	1

11061-1 Counter stay

for Internal Puller No 11060/0-2, for use on bearings, seals and bushes.



Code		
71 17 00 11	g 654	1

11061-2 Counter stay

for Internal Puller No 11060/3-7.

Code		
71 17 00 12	g 1500	1

12506-7 Hexagon nut spinner

flexible, size 7 mm, for screws on hose clips of radiator hose, max. tightening torque 8 N·m.



Code	Type		
43 10 32 07	Mercedes-Benz	g 168	10

10760CV-2,5-17 Hexagon key wrench

Fiat No A 89601 up to A 89611 for hexagon socket head screws, size 2.5 mm up to 17 mm (see page 247).



720Nf/80 Standard-MANOSKOP® torque wrench

capacity 160–800 N·m, 3/4" ○-drive.



Code	Type		
50 19 00 81	VW: LT Syncro	g 6102	1



Special automotive tools

730/5 Quick

SERVICE-MANOSKOP® torque wrench

capacity 5-50 N·m, for general service work.



Code	Type	g	g	g
50 18 40 05	VW/Audi	805	1	

732/10-13

Ring insert tool

size 13 mm, for use with SERVICE-MANOSKOP® torque wrench No 730/5.



Code	Type	g	g	g
58 22 10 13	VW/Audi	55	1	

735/10

Ratchet insert tool

reversible, 1/2" drive, for use with SERVICE-MANOSKOP® torque wrench No 730/5.



Code	Type	g	g	g
58 25 00 10	VW/Audi	147	1	

730/20 Quick

SERVICE-MANOSKOP® torque wrench

capacity 40-200 N·m.



Code	Type	g	g	g
50 18 40 20	VW/Audi	1250	1	

735/20

Ratchet insert tool

reversible, 1/2" drive, for use with SERVICE-MANOSKOP® torque wrench No 730/20.



Code	Type	g	g	g
58 25 00 20	VW/Audi	302	1	

730/40 Quick

SERVICE-MANOSKOP® torque wrench

capacity 80-400 N·m.



Code	Type	g	g	g
50 18 40 40	VW/Audi	1880	1	

735/40

Ratchet insert tool

reversible, 3/4" drive, for use with SERVICE-MANOSKOP® torque wrench No 730/40.



Code	Type	g	g	g
58 25 00 40	VW/Audi	510	1	

1421

Bit screwdriver socket

for inside TORX® screws, outside 1/4" C 6.3 size T45, length 26 mm, for use on door hinges. Drive Tools: f.e. ratchet reversible No 725/4B and ratchet tap holder No 1820 or ratchet reversible No 725/4B and torque wrench.



Code	Type	g	g	g
08 13 00 45	VW: Golf III	8	10	

Special tools for HGVs

34c/35c

Wheel braces

DIN 3119/ISO 6788, forged centre section, pressed-in extension arms with extra deep forged socket heads, Chrome Alloy Steel, chrome plated.



Code	No	mm/"	L mm	g	g
43 03 00 05	34c HGVs	24; 27; 32; 3/4"	700	5053	1
43 03 00 06	35c cars	17; 19; 22; 1/2"	400	2058	1

39

Tyre levers

Handy, sturdy construction, purposefully shaped, Chrome Alloy Steel.



Code	No	L mm	g	g
74 01 06 00	39/1 HGVs	600	897	5
74 01 06 02	39/2 HGVs	600	1172	5
74 01 06 03	39/3 HGVs	600	915	5
74 01 04 00	39 cars	400	383	5

1068 Air filter claw

for loosening of filter cartridges on air brakes (trucks).



Code	Clamp. width "	mm	total mm	length of claws mm	Δg g	
74620011	1/2	100-145	85	60	925	1

2509 ○ IMPACT sockets

3/4" ○-drive, for power drivers, extra deep, with reduced diameter, Chrome Alloy Steel, gunmetal finish.

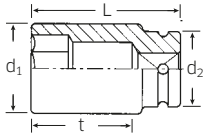

Code	mm	d ₁ mm	d ₂ mm	L mm	t mm	Δg g	
25090027	27	40.5	44	100	72.5	672	2
25090030	30	44.3	44	100	72.5	728	2
25090032	32	46.8	44	100	72	778	2
25090033	33	48	44	100	72	803	2

for Trilux wheels

2609 ○ IMPACT sockets

1" ○-drive, for power drivers, extra deep, with reduced outside diameter, Chrome Alloy Steel, gunmetal finish.

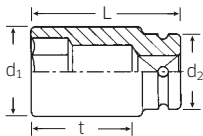

Code	mm	d ₁ mm	d ₂ mm	L mm	t mm	Δg g	
26090027	27	42.3	54	110	80	1001	2
26090030	30	46	54	110	79.5	1047	2
26090032	32	48.5	54	110	79	1015	2
26090033	33	49.8	54	110	78.5	1102	2

for wheel nuts

24-17x19 OPEN-RING spanner

bi-hexagon, size 17 x 19 mm, for all threaded connectors on injector pipes.



Code	Type	Δg g	
41081719	Mercedes-Benz	151	10

51-30 Socket

extra deep, bi-hexagon, size 30 mm, 1/2" ○-drive, on injector post.



Code	Type	Δg g	
03020030	Mercedes-Benz	341	5

440-27MB CROW-RING spanner

for setting of electronic injection on 440-HP-engines.



Code	Type	Δg g	
02191027	Mercedes-Benz	92	1

3678 4-pin socket

length 72 mm, 1/2" ○-drive, for use on pressure nut of injector post.



Code	Type	Δg g	
03810001	Mercedes-Benz	153	5

1054-10 INHEX socket

for hexagon socket head screws, size 10 mm, length 140 mm, 1/2" ○-drive, for cylinder head bolts.



Code	Type	Δg g	
03151410	Mercedes-Benz	150	5

3054X-M12 Screwdriver BIT

for tri-square socket head screws (XZN®), size 12, length 140 mm, Ø 11.5 mm, 1/2" ○-drive for cylinder head bolts with tri-square socket head M12.



Code	Type	Δg g	
03261412	Mercedes-Benz	160	5

11068-2 Piston ring compressor

of special spring steel, infinitely variable adjustment, c/w adj. spanner, capacity Ø 90-175 mm.



Code	Type	Δg g	
74140003	Mercedes-Benz	270	1

Special automotive tools

55-30 Socket

size 30 mm, hexagon 3/4" \odot -drive, for U-bolt nuts, front.



Code	Type	g	g	g
05 01 00 30	Mercedes-Benz	313	5	

55-36 Socket

size 36 mm, for U-bolt nuts, rear.

Code	Type	g	g	g
05 01 00 36	Mercedes-Benz	386	2	

24-10x12 OPEN-RING spanner

hexagon, size 10x12 mm, for general service work.



Code	Type	g	g	g
41 08 10 12	Mercedes-Benz	59	10	

440-30 CROW-RING spanner

size 30 mm, 1/2" \odot -drive for use on hydraulic pipe flare nuts.



Code	Type	g	g	g
03 19 00 30	Mercedes-Benz	155	1	

540-19 CROW-FOOT spanner

size 19 mm, for use on new push connector for pneumatic installations on new light-weight truck series.



Code	Type	g	g	g
02 20 00 19	Mercedes-Benz	64	1	

540-24 CROW-FOOT spanner

size 24 mm.

Code	Type	g	g	g
02 20 00 24		60	1	

730R/2 SERVICE-MANOSKOP® torque wrench

capacity 4-20 N-m, 3/8" \blacksquare -drive, for use on new push connector for pneumatic installations on new light-weight truck series.



Code	Type	g	g	g
96 50 20 02	Mercedes-Benz	455	1	

730R/40/32 Torque wrench set Quick

32 pieces, in steel case, for general service work.

Content:

- 1 SERVICE-MANOSKOP® No 730/40 Quick, 80-400 N-m,
- 1 ratchet insert tool No 735/20, reversible, 1/2" \blacksquare -drive;
- 1 square drive insert tool No 734/20, 1/2" \blacksquare -drive;
- 7 o/e insert tools No 731/40, sizes 13, 15, 17, 19, 22, 27, 30 mm
- 1 No 3731/40 size 24 mm;
- 7 ring insert tools No 732/40, sizes 13, 15, 17, 19, 22, 24, 27 mm
- 10 sockets, bi-hexagon No 50, sizes 13, 14, 15, 17, 19, 22, 24, 27, 30, 32 mm
- 4 accessories, 1/2" \odot -drive:
 - 1 T-handle No 506
 - 1 extension 255 mm No 509/10
 - 1 extension 130 mm No 509/5
 - 1 extension 55 mm No 509/2



Code	Type	g	g	g
96 50 20 53	Mercedes-Benz	9739	1	

54/12 Set of INHEX sockets

for hexagon socket head screws, in sturdy, stackable ABS plastic case, for general service work.

Content:

- 12 INHEX sockets
- No 54, sizes 4, 5, 6, 7, 8, 10, 12, 14, 17, 19 mm,
- No 3054/8, No 1054/10, 1/2" \odot -drive.



Code	Type	g	g	g
96 03 15 03	Mercedes-Benz	1963	1	

721Nf/80 Standard-MANOSKOP® torque wrench

capacity 160-800 N-m, 3/4" \blacksquare -drive, for general service work.



Code	Type	g	g	g
50 20 00 81	Mercedes-Benz	7222	1	

The STAHLWILLE KABELEX® range



Plug system	Tools	Private cars										Lorries				Contact size mm	No		
		BMW	Fiat	Ford	Mazda	Mercedes-Benz	Opel	PSA	Renault	Volvo	VW/Audi Seat/Skoda Porsche	MAN	Mercedes-Benz	Scania	Volvo				
Round plug systems/ crimp-contacts (The complete tool consists of ejection tool with bush)		•	•			•	•			•	•		•	•		•	Ø 1,5	1501 + 1511	
		•	•			•	•			•	•		•	•		•	Ø 3,5	1502 + 1512	
													•	•	•	•	Ø 4 ABS	1503 + 1513, 1523	
		•				•	•										Ø 2,5	1504 + 1514	
			•			•	•	•									Ø 2,3	1505 + 1515	
				•		•	•						•	•			Ø 4	1506 + 1516	
Round plug systems/ soldered contacts			•	•	•												Ø 1,5 pin contact	1575	
						•											Ø 4	1584	
			•			•											Ø 2,5	1585	
Flat plug systems with 2 or more locking tongues Crimp contacts		•		•		•	•	•	•		•	•			•		2,8	1551	
		•	•	•			•	•	•		•	•			•		5,8	1552	
						•	•	•	•	•							1,6	1556	
						•											9,5 Maxi Power Timer-contacts	1559	
							•										2,8 Ducon	1565	
							•										1,5 Ducon	1566	
													•				VKR box contact	1577	
													•			•	MKR/MKS-contacts	1577-1	
		•				•												SLK-contacts (primary)	1578K-1
		•				•												SLK-contacts 97 (primary+secondary)	1578K-2
		•				•												LSK-contacts	1589K
						•												1,65 E 95	1587
		•	•	•		•	•	•	•	•	•	•	•	•	•	•	•	2,8/5,8 Junior Power Timer-contacts Standard Power Timer-contacts	1591
	Flat plug systems with 2 locking tongues asymmetrical Crimp contacts																	0,64 MQS asymmetrically	1556-1
													•				2,8	1557	
													•				4,8	1558	
Flat plug systems with 1 locking tongue Crimp contacts		•	•	•	•	•	•	•	•	•	•	•	•	•	•	•	2,8/5,8	1553	
		•						•	•	•							2,8	1554	
		•						•	•								5,8	1555	
		•	•	•	•	•	•	•	•	•	•	•	•	•	•	•	•	Several Pid-Pod	1562
								•									0,8 Ducon	1563	
								•									1,5 Ducon	1564	
			•	•	•	•	•	•									1,6 Without box	1574	
													•				2,8	1576	



11 | VDE TOOLS

SETS OF TOOLS

→ PAGE 352



TORQUE WRENCHES

→ PAGE 353



RATCHETS, SOCKETS, SCREWDRIVER SOCKETS, EXTENSIONS

→ PAGE 353



SPANNERS

→ PAGE 354



SCREWDRIVERS

→ PAGE 355



PLIERS

→ PAGE 356



ACCESSORIES

→ PAGE 360





When things get hot, they keep cool.
VDE tools from STAHLWILLE.



The VDE range of products from STAHLWILLE – these tools allow you to work safely in »live« environments up to 1,000 volts – as accurately and efficiently as professional end users have come to expect of this brand. VDE-compliant tools by STAHLWILLE combine intelligent product design that is optimised to benefit users, high-grade materials, tight tolerances, outstanding ergonomics and long service lives with resilient, durable protective insulation. Each individual product – from open-jaw spanners and screwdrivers through to ratchets and torque wrenches – is certified to VDE standards by stringent test procedures and marked with the seal of approval for maximum safety.



- 1** **Interchangeable ratchet insert tool** – the only insulated torque wrench with a ratchet insert tool that users can exchange themselves (9 x 12 mm).
- 2** **Rapid adjustment without having to dismantle** – end-users can easily readjust the tool themselves – without having to send it in or have it retested.
- 3** **QuickSelect** – Proven QuickSelect setting of torque and an additional ring scale that allows fine adjustment.
- 4** **QuickRelease** – The ratchet insert tool can easily be switched from clockwise to anticlockwise use. The QuickRelease safety lock enables rapid tool changing but effectively protects against lost tools.
- 5** **No need for manual reset to zero** – wear-free triggering system with flexible rod. In contrast to conventional torque wrenches, it is not necessary to reset the wrench to zero after each job to unload the spring. In this way, users benefit from long-term accuracy and safe measurement results with less time required.



- 1** **VDE pliers & cutters** - these tools not only prevent flashover and dielectric breakdown up to 1000 volts, their excellent ergonomically refined handles reduce the effort required.
- 2** **VDE sockets, VDE screwdriver bits, VDE adapters** - these tools are covered with a resilient, twin-layer protective coating and offer extremely close tolerances and resilient materials.
- 3** **VDE fine-tooth ratchets** - the 80 teeth mean the ratchet angle is a tiny 4.5°, which allows the craftsman or craftswoman to apply exactly the right amount of force, even in confined spaces. They also provide optimum protection against live voltages in accordance with VDE standards.
- 4** **VDE screwdrivers** - extremely resilient to loads with effective protection against voltages up to 1000 volts. Handles with optimised ergonomics and tactile feedback that ensure ideal force transmission and strain-free working.
- 5** **VDE single-ended open-jaw spanners & single-ended ring spanners** - they not only provide protection against electric shocks, they also enable more efficient, safe working coupled with durability, because they use a double-T profile.
- 6** **Comprehensive VDE toolkit in a case and compact VDE tool sets** - the ideal storage solution for mobile work.

13300 VDE VDE case

- with 48 tools
- sturdy aluminium frame.
- ergonomically designed carrying handle.
- smooth-running rollers and integrated telescopic handle to simplify transport.



Code	⚖	kg
96 83 81 93		11.4
No 12171 VDE	3/8" ○ sizes 7; 8; 9; 10; 11; 12; 13; 14; 16; 17; 18; 19; 20; 22 mm	
No 12174 VDE	3/8" ○ sizes T20; T25; T30	
No 12175 VDE	3/8" ○ sizes M8; M10	
No 12167/3 VDE	3/8" ■ ○ 94 mm	
No 12167/6 VDE	3/8" ■ ○ 178 mm	
No 12167/10 VDE	3/8" ■ ○ 258 mm	
No 12165 VDE	3/8" ■	
No 4660 VDE	size 1 (0.4 x 2.5 x 75 mm) size 2 (0.5 x 3.0 x 100 mm) size 3 (0.6 x 3.5 x 100 mm) size 4 (0.8 x 4.0 x 100 mm)	
No 4665 VDE	sizes 1; 2; 3	
No 4675 VDE	sizes T8; T10; T15; T20; T25; T30	
No 6501 VDE	200 mm	
No 6508 VDE	160 mm	
No 6530 VDE	200 mm	
No 6551 VDE	250 mm	
No 6602 VDE	180 mm	
No 6630 VDE	220 mm	
No 12188 VDE		
No 12191 VDE		
No 12192 VDE		
No 12193 VDE		
No 12194 VDE	5x	
No 12195 VDE	5x	
No 13209 VDE		

12179/9/4 VDE VDE tool case 1/2"

TCS

in sturdy, stackable ABS plastic case,
13 pieces

Contents:

- 9 sockets with hexagon No 12179 VDE: sizes 10; 11; 12; 13; 14; 17; 19; 22; 24 mm
- 3 extensions No 12177/3 VDE (93 mm), No 12177/5 VDE (148 mm), No 12177/10 VDE (273 mm)
- 1 ratchet No 12173 VDE



Code	⚖	g
96 03 20 20		3800

TCS 12179/9/4 VDE VDE tools in TCS inlay 1/2"

NEW

TCS

350 x 350 x 45 mm,
13 pieces

Contents:

- 9 sockets with hexagon No 12179 VDE: sizes 10; 11; 12; 13; 14; 17; 19; 22; 24 mm
- 3 extensions No 12177/3 VDE (93 mm), No 12177/5 VDE (148 mm), No 12177/10 VDE (273 mm)
- 1 ratchet No 12173 VDE



Code	⚖	g
96 83 00 40		2800

12171/19/4 VDE VDE tool case 3/8"

TCS

in sturdy, stackable ABS plastic case,
23 pieces

Contents:

- 14 sockets with hexagon No 12171 VDE: sizes 7; 8; 9; 10; 11; 12; 13; 14; 16; 17; 18; 19; 20; 22 mm
- 3 screwdriver sockets for internal TORX® screws No 12174 VDE: sizes T20; T25; T30
- 2 screwdriver sockets for tri-square socket head screws XZN® No 12175 VDE: sizes M8; M10
- 3 extensions No 12167/3 VDE (94 mm), No 12167/6 VDE (178 mm), No 12167/10 VDE (258 mm)
- 1 ratchet No 12165 VDE



Code	⚖	g
96 02 20 20		3056

TCS 12171/19/4 VDE VDE tools in TCS inlay 3/8"

NEW

TCS

350 x 350 x 45 mm,
23 pieces

Contents:

- 14 sockets with hexagon No 12171 VDE: sizes 7; 8; 9; 10; 11; 12; 13; 14; 16; 17; 18; 19; 20; 22 mm
- 3 screwdriver sockets for internal TORX® screws No 12174 VDE: sizes T20; T25; T30
- 2 screwdriver sockets for tri-square socket head screws XZN® No 12175 VDE: sizes M8; M10
- 3 extensions No 12167/3 VDE (94 mm), No 12167/6 VDE (178 mm), No 12167/10 VDE (258 mm)
- 1 ratchet No 12165 VDE



Code	⚖	g
96 83 00 41		2000

730R VDE VDE MANOSKOP® torque wrench with QuickRelease ratchet



- click-type
- with double-insulated plastic sleeve against high voltages
- mount for interchangeable insert tools
- exchange of the ratchet 725QR VDE without having to recheck the insulation
- QuickRelease safety lock
- fast, accurate setting thanks to QuickSelect quick-action adjuster
- dual stop signal
- easy-to-read double scale with colour coding to differentiate between N-m/ft-lb and ft-lb/in-lb scales
- the measuring element is only under load while force is being applied, no need for manual reset to zero

- any force applied to the tool after the 'click' or applied in the opposite direction to the current function - e.g. forcible loosening of a jammed screw - does not act on the trigger mechanism and cannot cause damage to it.
- Insulation made of non-slip, abrasion-proof special plastic, resistant to diluted alkalis, hydrocarbons, fuels and oils.
- calibration using perfectControl calibrating unit No 7794 or calibration system No 7706. Adjustment without disassembly.
- with certificate
- display deviation value $\pm 3\%$

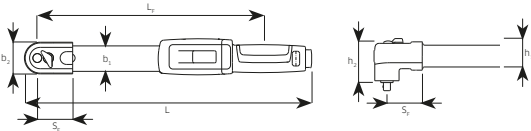

Code	size						fine scale			b ₁	b ₂	h ₁	h ₂	L	L _f	S _e	∅
							mm	"		mm	mm	mm	mm	mm	mm	mm	g
96550125	2.5	4-25 N-m	40-220 in-lb	2 N-m	10 in-lb	0.2 N-m	9x12	3/8		43	49.5	36	59.5	335.5	253.5	28	1230
96550150	5	10-50 N-m	7-37 ft-lb	5 N-m	1 ft-lb	0.25 N-m	9x12	3/8		43	49.5	36	59.5	390.5	308.5	28	1365

725QR VDE VDE QuickRelease ratchet insert tool



- reversible
- with QuickRelease safety lock
- 30 teeth
- Chrome-Alloy-Steel, chrome plated
- VDE insulated up to 1000 V
- DIN EN 60900
- AC/1000 V
- exclusively for MANOSKOP® 730 VDE

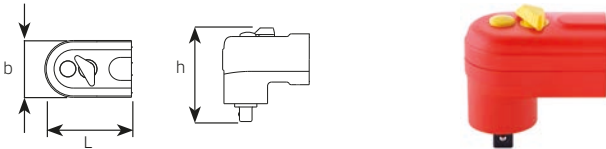

Code	"	mm	b	h	L	∅
			mm	mm	mm	g
58253105	3/8	9x12	43	70.5	65.5	220

12171 VDE VDE sockets 3/8"



HPQ® high performance steel, chrome plated; VDE insulated up to 1000 V; DIN EN 60900; AC/1000 V

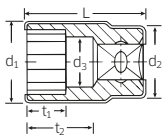

Code	∅	d ₁	d ₂	d ₃	L	t ₁	t ₂	∅	
	mm	mm	mm	mm	mm	mm	mm	g	
02380007	7	15.5	21.5	6	42	6	12.5	24	1
02380008	8	16.7	21.5	7	43	7	13.5	26	1
02380009	9	18	21.5	8	43	7	13.5	28	1
02380010	10	19.3	21.5	9	45	8.5	15.5	28	1
02380011	11	20.6	21.5	10	45	8.5	13.7	32	1
02380012	12	21.9	22.5	11	46	9.5	14.4	36	1
02380013	13	23	22.5	12	48	11.5	16.1	36	1
02380014	14	24.4	22.5	13	48	11.5	15.8	40	1
02380016	16	26.7	24	15	49	13.5	18.9	48	1
02380017	17	28	24	16	49	12.5	18.6	54	1
02380018	18	29.2	24	17	50	13.5	19.3	58	1
02380019	19	30.2	24	18	50	13.5	19	62	1
02380020	20	31.2	25	19	52	15.5	20.7	68	1
02380022	22	33.7	26	21	53	17	21.2	78	1

12165 VDE VDE QuickRelease fine-tooth ratchet 3/8"



- reversible
- 80 teeth
- with double-insulated plastic sleeve against high voltages
- with QuickRelease safety lock and 2-component handle
- for use in confined spaces
- re-engages after movement of 4.5°
- construction without screws prevents foreign object damage
- VDE insulated up to 1000 V
- DIN EN 60900
- AC/1000 V

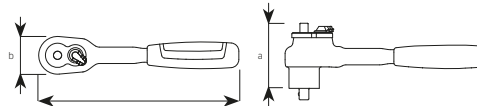

Code	b	a	L	∅
	mm	mm	mm	g
12430001	37	61	205	298

12173 VDE VDE QuickRelease fine-tooth ratchet 1/2"



- reversible
- 80 teeth
- with double-insulated plastic sleeve against high voltages
- with QuickRelease safety lock and 2-component handle
- for use in confined spaces
- re-engages after movement of 4.5°
- construction without screws prevents foreign object damage
- VDE insulated up to 1000 V
- DIN EN 60900
- AC/1000 V

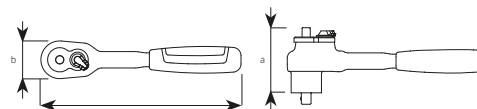

Code	b	a	L	∅
	mm	mm	mm	g
13430001	48	69	265	656

VDE tools

12167 VDE VDE extensions 3/8"

Chrome-Alloy-Steel, chrome plated; VDE insulated up to 1000 V; DIN EN 60900; ⚡ AC/1000 V

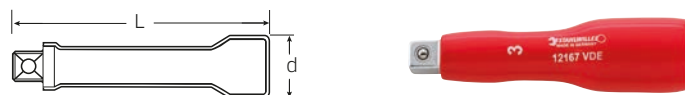

Code	size	L mm	d mm	⌀ g	
12 42 00 01	3	94	23	84	1
12 42 00 02	6	178	23	162	1
12 42 00 03	10	258	23	224	1

12174 VDE VDE screwdriver sockets 3/8"

for internal TORX® screws; Chrome-Alloy-Steel, chrome plated; VDE insulated up to 1000 V; DIN EN 60900; ⚡ AC/1000 V



Code	size	mm	L mm	d mm	⌀ g	
02 39 00 20	T20	3.8	67	22.8	52	1
02 39 00 25	T25	4.4	67	22.8	52	1
02 39 00 30	T30	5.5	67	22.8	54	1
02 39 00 40	T40	6.6	67	22.8	56	1
02 39 00 45	T45	7.8	67	22.8	58	1

12175 VDE VDE screwdriver sockets 3/8"

for tri-square socket head screws (XZN®); Chrome-Alloy-Steel, chrome plated; VDE insulated up to 1000 V; DIN EN 60900; ⚡ AC/1000 V



Code	size	L mm	d mm	⌀ g	
02 37 00 08	M8	148	22.8	98	1
02 37 00 10	M10	148	22.8	122	1

12177 VDE VDE extensions 1/2"

Chrome-Alloy-Steel, chrome plated; VDE insulated up to 1000 V; DIN EN 60900; ⚡ AC/1000 V

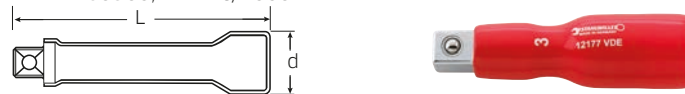

Code	size	L mm	d mm	⌀ g	
13 42 00 01	3	93	27	130	1
13 42 00 02	5	148	27	206	1
13 42 00 03	10	273	27	380	1

12179 VDE VDE sockets 1/2"



HPQ® high performance steel, chrome plated; VDE insulated up to 1000 V; DIN EN 60900; ⚡ AC/1000 V



Code	⌀ mm	d ₁ mm	d ₂ mm	d ₃ mm	L mm	t ₁ mm	t ₂ mm	⌀ g	
03 37 00 10	10	19.5	27	9	56	9	22	60	1
03 37 00 11	11	20.8	27	10	56	9.5	22	64	1
03 37 00 12	12	22	27	11	56	13	22	64	1
03 37 00 13	13	23.3	27	12	56	13	22	64	1
03 37 00 14	14	24.9	27.7	13	56	13	20.5	70	1
03 37 00 17	17	29	28.7	15.2	56	15	19.6	82	1
03 37 00 19	19	31.2	30	18	56	16	21.7	98	1
03 37 00 22	22	34.7	31	21	60	16.5	24.9	116	1
03 37 00 24	24	37	31	21	60	18.5	24.9	130	1

12160 VDE VDE single-end open-jaw spanners

Chrome-Alloy-Steel, chrome plated; VDE insulated up to 1000 V; DIN EN 60900; ⚡ AC/1000 V

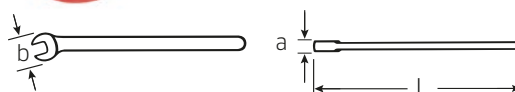

Code	⌀ mm	L mm	b mm	a mm	⌀ g	
44 18 00 10	10	140.7	26	10.5	48	1
44 18 00 13	13	166.4	32.5	11.5	80	1
44 18 00 14	14	181	34.5	11.5	88	1
44 18 00 17	17	200	40	12.5	146	1
44 18 00 19	19	218	44.5	13	184	1
44 18 00 22	22	248	50	13.5	254	1

12160/6 VDE VDE single-end open-jaw spanners NEW

6 pieces;
sizes 10; 13; 14; 17; 19; 22 mm;
Chrome-Alloy-Steel, chrome plated;
in roll-up wallet;
VDE insulated up to 1000 V;
DIN EN 60900;
⚡ AC/1000 V



Code	⌀ g	
96 40 43 01	900	1

 Made in
Germany

TCS 12160 VDE

NEW



175 x 350 x 40 mm, 6 pieces

Code	g
96 83 00 42	900

No 12160 VDE sizes 10; 13; 14; 17; 19; 22 mm

12161 VDE VDE single-end ring spanners

AS DRIVE

Chrome-Alloy-Steel, chrome plated; VDE insulated up to 1000 V; DIN EN 60900; AC/1000 V

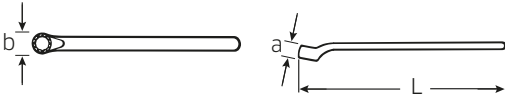

Code	Ø mm	L mm	b mm	a mm	g	
44 19 00 10	10	147.6	19.6	13	48	1
44 19 00 13	13	171.2	23.6	15	82	1
44 19 00 14	14	184.1	25.1	15	92	1
44 19 00 17	17	208.3	29.1	17	144	1
44 19 00 19	19	227.1	32	18	190	1
44 19 00 22	22	254.2	36.3	19	238	1

12161/6 VDE VDE single-end ring spanners

NEW

6 pieces; sizes 10; 13; 14; 17; 19; 22 mm; Chrome-Alloy-Steel, chrome plated; in roll-up wallet; VDE insulated up to 1000 V; DIN EN 60900; AC/1000 V



Code	g	
96 40 43 02	810	1

TCS 12161 VDE

NEW



175 x 350 x 40 mm, 6 pieces

Code	g
96 83 00 45	885

No 12161 VDE sizes 10; 13; 14; 17; 19; 22 mm

4660 VDE

VDE electricians screwdrivers DRALL+

- for slotted screws
- Chrome Alloy Steel
- blade gunmetal finished
- VDE insulated up to 1000 V
- DIN EN 60900
- AC/1000 V

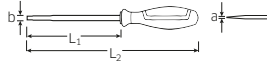

Code	size	a mm	b mm	L ₁ mm	L ₂ mm	g	
46 60 30 25	1	0.4	2.5	75	160	43	10
46 60 30 30	2	0.5	3.0	100	185	39	10
46 60 30 35	3	0.6	3.5	100	205	42	10
46 60 30 40	4	0.8	4.0	100	205	46	10
46 60 30 55	5	1.0	5.5	125	240	93	10
46 60 30 65	6	1.2	6.5	150	265	120	10
46 60 30 80	7	1.2	8.0	175	300	170	10

4665 VDE

VDE cross-head screwdrivers DRALL+

- Phillips-Recess®
- Chrome Alloy Steel
- blade gunmetal finished
- VDE insulated up to 1000 V
- DIN EN 60900
- AC/1000 V



Code	PH size	L ₁ mm	L ₂ mm	g	
46 65 30 00	0	60	145	35	10
46 65 30 01	1	80	185	47	10
46 65 30 02	2	100	215	89	10
46 65 30 03	3	150	275	159	10

4670 VDE

VDE cross-head screwdrivers DRALL+

- POZIDRIV/SUPADRIV®
- Chrome Alloy Steel
- blade gunmetal finished
- VDE insulated up to 1000 V
- DIN EN 60900
- AC/1000 V



Code	PH size	L ₁ mm	L ₂ mm	g	
46 70 30 00	0	60	145	36	10
46 70 30 01	1	80	185	46	10
46 70 30 02	2	100	215	89	10

4675 VDE

VDE TORX® screwdrivers DRALL+

- for inside TORX® screws
- Chrome Alloy Steel
- blade gunmetal finished
- VDE insulated up to 1000 V
- DIN EN 60900
- AC/1000 V



Code	size	mm	L ₁ mm	L ₂ mm	g	
46 75 30 08	T8	2.3	60	145	22	10
46 75 30 10	T10	2.7	60	145	22	10
46 75 30 15	T15	3.3	75	180	40	10
46 75 30 20	T20	3.8	100	205	47	10
46 75 30 25	T25	4.4	100	205	51	10
46 75 30 30	T30	5.5	100	215	93	10

VDE tools

4695 VDE VDE screwdriver set DRALL+

Set with 6 screwdrivers DRALL+

- VDE insulated up to 1000 V
- DIN EN 60900
- AC/1000 V

⊖ 4660 VDE:

- size 1 (0.4 x 2.5 x 75 mm)
- size 3 (0.6 x 3.5 x 100 mm)
- size 5 (1.0 x 5.5 x 125 mm)
- size 6 (1.2 x 6.5 x 150 mm)

⊕ 4665 VDE: size 1; size 2



Code	⊖	g	⊕
96 46 95 15	620		1

TCS 4600/4665 VDE



TCS



175 x 350 x 40 mm, 6 pieces

Code	⊖	g
96 83 87 66	391	

No 4660 VDE	size 1 (0.4 x 2.5 x 75 mm)
	size 3 (0.6 x 3.5 x 100 mm)
	size 5 (1.0 x 5.5 x 125 mm)
	size 6 (1.2 x 6.5 x 150 mm)

No 4665 VDE	sizes 1; 2

TCS 4665/4670 VDE



TCS



175 x 350 x 40 mm, 7 pieces

Code	⊖	g
96 83 87 85	580	

No 4665 VDE	sizes PH0; PH1; PH2; PH3
No 4670 VDE	sizes PZ0; PZ1; PZ2

TCS 4675 VDE

NEW



TCS



175 x 350 x 40 mm, 6 pieces

Code	⊖	g
96 83 87 93	385	

No 4675 VDE	sizes T8; T10; T15; T20; T25; T30

4798 VDE VDE set of reversible screwdrivers

- 14 pieces
 - with attachable revolving cap for use as precision tools
 - secure hold of the blades in the handle
 - automatic locking against unintentional removal
 - VDE insulated up to 1000 V
 - DIN EN 60900
 - AC/1000 V
- Contents:
- ⊖ 2.5 x 0.4; 3.0 x 0.5; 3.5 x 0.6; 4.0 x 0.8; 5.5 x 1.0; 6.5 x 1.2 mm
 - ⊕ size 1; 2
 - ⊕ size 2
 - T10; T15; T20



Code	⊖	g	⊕
96 46 95 11	814		1

TCS 6501-6600/3 VDE



TCS



175 x 350 x 40 mm, 3 pieces

Code	⊖	g
96 83 87 70	725	

No 65 01 7 180

No 65 29 7 200

No 66 00 7 160

TCS 6501/6551/6600 VDE

NEW



TCS



175 x 350 x 40 mm, 3 pieces

Code	⊖	g
96 83 00 39	857	

No 65 01 7 180

No 65 51 7 240

No 66 00 7 160

6501 VDE VDE combination pliers

DIN ISO 5746, precision cutting edges for all wires, incl. piano wire, induction hardened cutting edges, approx. 62 HRC, for long life.



Code	L mm	Head	Handles	③	④	⑤	⑥	∅ _g
6501 7 160	160	chrome plated	dip-coated insulation DIN EN 60900, $\text{AC}/1000\text{ V}$	1.8	1.5	10	16	202
6501 7 180	180			2	1.8	12	16	279
6501 7 200	200			2.5	2	13	16	359
6501 8 160	160	chrome plated	insulated, with plastic sleeves, DIN EN 60900, $\text{AC}/1000\text{ V}$	1.8	1.5	10	16	186
6501 8 180	180			2	1.8	12	16	186
6501 8 200	200			2.5	2	13	16	317

③ Cutting capacity in mm for hard wire
⑤ Cutting capacity in mm for cable

④ Cutting capacity in mm for piano wire
⑥ Cutting capacity in mm² for cable

6507 VDE VDE flat nose pliers, short

DIN ISO 5745, short, flat serrated jaws.



Code	L mm	Head	Handles	L ₃ mm	W mm	T mm	h mm	b mm	∅ _g
6507 7 160	160	chrome plated	dip-coated insulation DIN EN 60900, $\text{AC}/1000\text{ V}$	30	17	10	5	9	200
6507 8 160	160	chrome plated	insulated, with plastic sleeves, DIN EN 60900, $\text{AC}/1000\text{ V}$	30	17	10	5	9	181

6508 VDE VDE flat nose pliers, long

DIN ISO 5745, long, flat serrated jaws.



Code	L mm	Head	Handles	L ₃ mm	W mm	T mm	h mm	b mm	∅ _g
6508 7 160	160	chrome plated	dip-coated insulation DIN EN 60900, $\text{AC}/1000\text{ V}$	50	15	8	3	5	148
6508 8 160	160	chrome plated	insulated, with plastic sleeves, DIN EN 60900, $\text{AC}/1000\text{ V}$	50	15	8	3	5	166

6523 VDE VDE round nose pliers, short

DIN ISO 5745, for bending wire loops and rings, short, round, ground jaws, fine serrations on gripping areas.



Code	L mm	Head	Handles	L ₃ mm	W mm	T mm	b mm	∅ _g
6523 7 160	160	chrome plated	dip-coated insulation DIN EN 60900, $\text{AC}/1000\text{ V}$	30	18	10	3	201
6523 8 160	160	chrome plated	insulated, with plastic sleeves, DIN EN 60900, $\text{AC}/1000\text{ V}$	30	18	10	3	176

6524 VDE VDE round nose pliers, long

DIN ISO 5745, for bending wire loops and rings, long, round, ground jaws, fine serrations on gripping areas.



Code	L mm	Head	Handles	L ₃ mm	W mm	T mm	b mm	∅ _g
6524 7 160	160	chrome plated	dip-coated insulation DIN EN 60900, $\text{AC}/1000\text{ V}$	47	15.5	8.5	2.5	162
6524 8 160	160	chrome plated	insulated, with plastic sleeves, DIN EN 60900, $\text{AC}/1000\text{ V}$	47	15.5	8.5	2.5	156

VDE tools

6529 VDE VDE snipe nose pliers with cutter (radio- or telephone pliers)

DIN ISO 5745, Form A (straight), half round, long tapering, serrated jaws, with burner hole, precision cutting edges for soft and hard wires, induction hardened cutting edges, approx. 60 HRC.



6529 7 160



6529 8 160

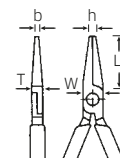

Code	L mm	Head	Handles	L ₃ mm	W mm	T mm	h mm	b mm	ΔΔ g
6529 7 160	160	chrome plated	dip-coated insulation DIN EN 60900, ⚡ AC/1000 V	51	16	9	3	2.5	174
6529 7 200	200			73	17	9	3	2.5	226
6529 8 160	160	chrome plated	insulated, with plastic sleeves, DIN EN 60900, ⚡ AC/1000 V	51	16	9	3	2.5	158
6529 8 200	200			73	17	9	3	2.5	202

6530 VDE VDE snipe nose pliers with cutter (radio- or telephone pliers)

DIN ISO 5745, Form B, bent 45°, half round, long tapering, serrated jaws, with burner hole, precision cutting edges for soft and hard wires, induction hardened cutting edges, approx. 60 HRC.



6530 7 160



6530 8 160

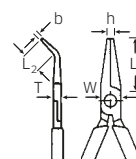

Code	L mm	Head	Handles	L ₂ mm	L ₃ mm	W mm	T mm	h mm	b mm	ΔΔ g
6530 7 160	160	chrome plated	dip-coated insulation DIN EN 60900, ⚡ AC/1000 V	24	55	16	9	3	2.5	185
6530 7 200	200			28	76	17	9	3.5	2.5	230
6530 8 160	160	chrome plated	insulated, with plastic sleeves, DIN EN 60900, ⚡ AC/1000 V	24	55	16	9	3	2.5	154
6530 8 200	200			28	76	17	9	3.5	3	201

6533 VDE VDE mechanics snipe nose pliers

half round, long tapering, serrated jaws.



6533 7 160



6533 8 160

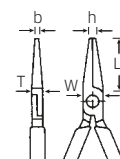

Code	L mm	Head	Handles	L ₃ mm	W mm	T mm	h mm	b mm	ΔΔ g
6533 7 160	160	chrome plated	dip-coated insulation DIN EN 60900, ⚡ AC/1000 V	50	15	8	3	2.5	147
6533 8 160	160	chrome plated	insulated, with plastic sleeves, DIN EN 60900, ⚡ AC/1000 V	50	15	8	3	2.5	160

6551 VDE VDE waterpump wrench

- DIN ISO 8976 (No 207 c)
- with box joint and recess
- 7 positions
- anti-pinch mechanism
- chrome vanadium



Code	L mm	Jaw opening max. mm	Head	Handles	ΔΔ g
6551 7 240	250	35	chrome plated	dip-coated insulation DIN EN 60900, ⚡ AC/1000 V	162

6600 VDE VDE side cutters ✂

DIN ISO 5749, Form B, precision cutting edges for all wires incl. piano wire, high quality alloy steel, bevelled cutting edges induction hardened, approx. 63 HRC.



6600 7 145



6600 8 160

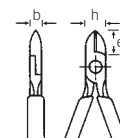

Code	L mm	Head	Handles	e mm	h mm	b mm	①	②	③	④	ΔΔ g
6600 7 145	140	chrome plated	dip-coated insulation DIN EN 60900, ⚡ AC/1000 V	19	20	8.2	3	2.5	1.8	1.6	155
6600 7 160	160			23.5	20	9	3	2.8	2	1.6	215
6600 7 180	180			25.5	25	9.5	3.8	3	2.5	2	270
6600 8 145	140	chrome plated	insulated, with plastic sleeves, DIN EN 60900, ⚡ AC/1000 V	19	20	8.2	3	2.5	1.8	1.6	149
6600 8 160	160			23.5	20	9	3	2.8	2	1.6	190
6600 8 180	180			25.5	25	9.5	3.8	3	2.5	2	249

- ① Cutting capacity in mm for soft wire
- ② Cutting capacity in mm for medium hard wire
- ③ Cutting capacity in mm for hard wire
- ④ Cutting capacity in mm for piano wire

6602 VDE VDE heavy duty side cutters

DIN ISO 5749, Form A, precision cutting edges for all wires incl. piano wire, high quality alloy steel, bevelled cutting edges induction hardened, approx. 63 HRC.



6602 7 160



6602 8 160

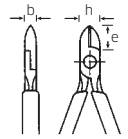

Code	L mm	Head	Handles	e mm	h mm	b mm	①	②	③	④	⚡ g
6602 7 160	160	chrome plated	dip-coated insulation, DIN EN 60900	25.5	25	9.5	4	3.4	2.5	2	220
6602 7 200	200			31	28	11.5	4	4	3	2.5	325
6602 7 250	250			32	29.5	12	4	4	3.5	3	475
6602 8 160	160	chrome plated	insulated, with plastic sleeves, DIN EN 60900	25.5	25	9.5	4	3.4	2.5	2	210
6602 8 180	180			27.5	26.5	10.5	4	3.8	2.7	2.2	250
6602 8 200	200			31	28	11.5	4	4	3	2.5	305

① Cutting capacity in mm for soft wire
③ Cutting capacity in mm for hard wire

② Cutting capacity in mm for medium hard wire
④ Cutting capacity in mm for piano wire

6622 VDE VDE wire stripping pliers

with adjustment screw to cut insulation only on wire or cable, max. 5 mm \varnothing 10 mm² conductor cross-section.



6622 7 160



6622 8 160

Code	L mm	Head	Handles	⚡ g
6622 7 160	160	chrome plated	dip-coated insulation DIN EN 60900,	180
6622 8 160	160	chrome plated	insulated, with plastic sleeves, DIN EN 60900,	168

6623 VDE VDE wire stripping pliers

for wires from 0.5 to 5 mm \varnothing , self adjusting, cutter hole for cutting wire or stranded wires up to 5 mm \varnothing , special steel.



6623 7 160



6623 8 160

Code	L mm	Head	Handles	⚡ g
6623 7 160	160	chrome plated	dip-coated insulation DIN EN 60900,	180
6623 8 160	160	chrome plated	insulated, with plastic sleeves, DIN EN 60900,	168

6923 Replacement stripping knives (1 pair) for No 6623

Code	⚡ g
6923 71 60	11

6630 VDE VDE cable shear

for copper and light alloy cables. Easy, single handed operation. Special cutter geometry to avoid pressure marks and frayed ends, adjustable joint, anti-squeeze protection, not suitable for steel or armoured cables.



Code	L mm	Head	Handles	⑦	⑧	⑨	⚡ g
6630 7 220	220	chrome plated	dip-coated insulation, DIN EN 60900	16	35	70	380

⑦ cutting capacity in mm² for single wire Al-/Cu-Cable
⑨ cutting capacity in mm² for thin wire Al-/Cu-Cable

⑧ cutting capacity in mm² for multiple wire Al-/Cu-Cable

VDE tools

12187 VDE VDE electrician's penknife

- with a straight blade
- handle made of viscoelastic, impact-resistant plastic
- with blade cover



Code	Blade mm	g	g	g
77020700	50	98	1	

12188 VDE VDE electrician's penknife

- with a hooked blade
- for slitting and stripping moisture proof cables
- handle made of viscoelastic, impact-resistant plastic
- with blade cover



Code	Blade mm	g	g	g
77020701	40	96	1	

12189 VDE VDE insulating underlay mat

- tested to IEC 6111 Class 4
- for working on high-current components
- one side is smooth, one side with non-slip grooves



Code	Dimensions mm	g	g	g
77030700	1000 x 1000 x 4.5	3040	1	

12190 VDE VDE bag with a carry cord

- for the VDE insulating underlay mat



Code	Dimensions mm	g	g	g
77030701	1000 x 300	784	1	

12196 VDE VDE insulating underlay mat in bag



Code	Dimensions mm	g	g	g
96404303	1000 x 300	3824	1	

12191 VDE VDE barrier tape

- red & white markings
- for cordoning off construction sites and securing hazard zones
- full warning effect retained even over longer periods (light resistance rating: 5-6)
- made of polyethylene



Code	L m	B mm	g	g
77030702	500	80	1500	1

12192 VDE VDE warning sign

- warning regarding hazardous electric voltages
- DIN EN ISO 7010-W012
- made of plastic



Code	mm	g	g	g
77030705	200 x 200	27	1	

12193 VDE VDE prohibitory sign

- prohibitory sign „Do not switch on“
- DIN 4844, BGV A8 (accident prevention regulations)
- made of plastic



Code	∅ mm	g	g	g
77030706	200	48	1	

12194/12195 VDE Self-clamping VDE insulating cable-end cap

- for insulating the ends of cables and individual wire cores
- made of viscoelastic insulating material
- with cross-section closure



Code	∅ mm	L mm	g	g
77030708	10	100	10	1
77030709	20	100	18	1

13209 VDE VDE hard case

- with detachable trolley castor system
- sturdy aluminium frame
- 2 locks
- ergonomically designed carrying handle
- robust jointed lid-prop
- tool-holder panel for storing tools from both sides, with 21 pockets and integrated document pouch
- ABS insert can be subdivided and includes cover with 6 pockets



Code	Dimensions mm	g	g	g
81620700	460 x 375 x 235	6000	1	

Inch pound (in-lb) – newton metres (N-m)										
	0	10	20	30	40	50	60	70	80	90
in-lb	N-m									
0	0.0	1.1	2.3	3.4	4.5	5.7	6.8	7.9	9.0	10.2
100	11.3	12.4	13.6	14.7	15.8	17.0	18.1	19.2	20.3	21.5
200	22.6	23.7	24.9	26.0	27.1	28.3	29.4	30.5	31.6	32.8
300	33.9	35.0	36.2	37.3	38.4	39.6	40.7	41.8	42.9	44.1
400	45.2	46.3	47.5	48.6	49.7	50.9	52.0	53.1	54.2	55.4
500	56.5	57.6	58.8	59.9	61.0	62.2	63.3	64.4	65.5	66.7
600	67.8	68.9	70.1	71.2	72.3	73.5	74.6	75.7	76.8	78.0
700	79.1	80.2	81.4	82.5	83.6	84.8	85.9	87.0	88.1	89.3
800	90.4	91.5	92.7	93.8	94.9	96.1	97.2	98.3	99.4	100.6
900	101.7	102.8	104.0	105.1	106.2	107.4	108.5	109.6	110.7	111.9
1000	113.0	114.1	115.3	116.4	117.5	118.7	119.8	120.9	122.0	123.2
1100	124.3	125.4	126.6	127.7	128.8	130.0	131.1	132.2	133.3	134.5
1200	135.6	136.7	137.9	139.0	140.1	141.3	142.4	143.5	144.6	145.8
1300	146.9	148.0	149.2	150.3	151.4	152.6	153.7	154.8	155.9	157.1
1400	158.2	159.3	160.5	161.6	162.7	163.9	165.0	166.1	167.2	168.4
1500	169.5	170.6	171.8	172.9	174.0	175.2	176.3	177.4	178.5	179.7
1600	180.8	181.9	183.1	184.2	185.3	186.5	187.6	188.7	189.8	191.0
1700	192.1	193.2	194.4	195.5	196.6	197.8	198.9	200.0	201.1	202.3
1800	203.4	204.5	205.7	206.8	207.9	209.1	210.2	211.3	212.4	213.6
1900	214.7	215.8	217.0	218.1	219.2	220.4	221.5	222.6	223.7	224.9
2000	226.0	227.1	228.3	229.4	230.5	231.7	232.8	233.9	235.0	236.2
2100	237.3	238.4	239.6	240.7	241.8	243.0	244.1	245.2	246.3	247.5
2200	248.6	249.7	250.9	252.0	253.1	254.3	255.4	256.5	257.6	258.8
2300	259.9	261.0	262.2	263.3	264.4	265.6	266.7	267.8	268.9	270.1
2400	271.2	272.3	273.5	274.6	275.7	276.9	278.0	279.1	280.2	281.4
2500	282.5	283.6	284.8	285.9	287.0	288.2	289.3	290.4	291.5	292.7
2600	293.8	294.9	296.1	297.2	298.3	299.5	300.6	301.7	302.8	304.0
2700	305.1	306.2	307.4	308.5	309.6	310.8	311.9	313.0	314.1	315.3
2800	316.4	317.5	318.7	319.8	320.9	322.1	323.2	324.3	325.4	326.6
2900	327.7	328.8	330.0	331.1	332.2	333.4	334.5	335.6	336.7	337.9
3000	339.0	340.1	341.3	342.4	343.5	344.7	345.8	346.9	348.0	349.2
3100	350.3	351.4	352.6	353.7	354.8	356.0	357.1	358.2	359.3	360.5
3200	361.6	362.7	363.9	365.0	366.1	367.3	368.4	369.5	370.6	371.8
3300	372.9	374.0	375.2	376.3	377.4	378.6	379.7	380.8	381.9	383.1
3400	384.2	385.3	386.5	387.6	388.7	389.9	391.0	392.1	393.2	394.4
3500	395.5	396.6	397.8	398.9	400.0	401.2	402.3	403.4	404.5	405.7
3600	406.8	407.9	409.1	410.2	411.3	412.5	413.6	414.7	415.8	417.0

Foot pound (ft-lb) – newton metres (N-m)										
	0	1	2	3	4	5	6	7	8	9
ft-lb	N-m									
0	0.0	1.4	2.7	4.1	5.4	6.8	8.1	9.5	10.9	12.2
10	13.6	14.9	16.3	17.6	19.0	20.3	21.7	23.1	24.4	25.8
20	27.1	28.5	29.8	31.2	32.5	33.9	35.3	36.6	38.0	39.3
30	40.7	42.0	43.4	44.7	46.1	47.5	48.8	50.2	51.5	52.9
40	54.2	55.6	56.9	58.3	59.7	61.0	62.4	63.7	65.1	66.4
50	67.8	69.2	70.5	71.9	73.2	74.6	75.9	77.3	78.6	80.0
60	81.4	82.7	84.1	85.4	86.8	88.1	89.5	90.8	92.2	93.6
70	94.9	96.3	97.6	99.0	100.3	101.7	103.0	104.4	105.8	107.1
80	108.5	109.8	111.2	112.5	113.9	115.3	116.6	118.0	119.3	120.7
90	122.0	123.4	124.7	126.1	127.5	128.8	130.2	131.5	132.9	134.2
100	135.6	136.9	138.3	139.7	141.0	142.4	143.7	145.1	146.4	147.8
110	149.1	150.5	151.9	153.2	154.6	155.9	157.3	158.6	160.0	161.3
120	162.7	164.1	165.4	166.8	168.1	169.5	170.8	172.2	173.6	174.9
130	176.3	177.6	179.0	180.3	181.7	183.0	184.4	185.8	187.1	188.5
140	189.8	191.2	192.5	193.9	195.2	196.6	198.0	199.3	200.7	202.0
150	203.4	204.7	206.1	207.4	208.8	210.2	211.5	212.9	214.2	215.6
160	216.9	218.3	219.6	221.0	222.4	223.7	225.1	226.4	227.8	229.1
170	230.5	231.9	233.2	234.6	235.9	237.3	238.6	240.0	241.3	242.7
180	244.1	245.4	246.8	248.1	249.5	250.8	252.2	253.5	254.9	256.3
190	257.6	259.0	260.3	261.7	263.0	264.4	265.7	267.1	268.5	269.8
200	271.2	272.5	273.9	275.2	276.6	277.9	279.3	280.7	282.0	283.4
210	284.7	286.1	287.4	288.8	290.2	291.5	292.9	294.2	295.6	296.9
220	298.3	299.6	301.0	302.4	303.7	305.1	306.4	307.8	309.1	310.5
230	311.8	313.2	314.6	315.9	317.3	318.6	320.0	321.3	322.7	324.0
240	325.4	326.8	328.1	329.5	330.8	332.2	333.5	334.9	336.2	337.6
250	339.0	340.3	341.7	343.0	344.4	345.7	347.1	348.5	349.8	351.2
260	352.5	353.9	355.2	356.6	357.9	359.3	360.7	362.0	363.4	364.7
270	366.1	367.4	368.8	370.1	371.5	372.9	374.2	375.6	376.9	378.3
280	379.6	381.0	382.3	383.7	385.1	386.4	387.8	389.1	390.5	391.8
290	393.2	394.5	395.9	397.3	398.6	400.0	401.3	402.7	404.0	405.4
300	406.8									

Index of numbers

No	Page	No	Page	No	Page	No	Page	No	Page
AB 95	12	TCS 10/11;		TCS 12171/19/4 VDE	352	55, 55a, Sets	145-147	445	121
AB 98	13	6x7-34x36 mm	55, 79	TCS 12179/9/4 VDE	352	55IMP	160	446/08	23
BL 150	280	TCS 10+13+24/30	55, 79	TCS TX/57 MF N	64	55/6, 55/7	152	447, 447a	151, 217
BL 153	280	TCS 10a/9	55, 79	TCS WT 10/10, 6-32 mm	19	56	145	447aSP	151, 217
BL 1500	280	TCS 12+13+14/29	56, 82	TCS WT 10a/9	19	56IMP	160	452QR	121
BZ 150/3/4	280	TCS 13/17; 6-24 mm	56, 82	TCS WT 13/18, 6-24 mm	20	59, 59X, 59TX	145	453QR	122
BZ 153	280	TCS 13/17; 6-24 mm MF	56, 82	TCS WT 13a/22	20	60	148	456	117
BZ 1500	280	TCS 13/18; 6-24 mm	55, 81	TCS WT 17/12	20	60 Sets	149	456, Sets	124, 125
ES 1/4" + 10760CV	47, 115	TCS 13/21; 6-34 mm	56, 82	TCS WT 40/45/46/37/14	20	60IMP	161	460a	117
ES 1/2"-512/6	47, 144	TCS 13/25; 5,5-34 mm	56, 82	TCS WT 40/52/27/13	21	60/1, 60/2	152	501	138
ES 10/10;		TCS 13a/19	56, 82	TCS WT 40/4008/10/9	20	64	148	501QR	138
5,5x7-22x24 mm	45, 78	TCS 13a/23	56, 83	TCS WT 102-109/16	22	66IMP	161	502 1/2	220, 233
ES 10/10;		TCS 14/5; 17-21 mm	57, 84	TCS WT 240/10	20	70IMP	162	504	138
6x7-30x32 mm	45, 79	TCS 14/8; 8-16 mm	57, 84	TCS WT 4622-4650	21	70V	220	506	138
ES 13/5; 27-32 mm	45, 81	TCS 14/8; 6-24 mm	57, 84	TCS WT 4622-4650-1	21	70VK	233	506QR	138
ES 13/8; 16-24 mm	45, 81	TCS 14/21; 6-36 mm	57, 84	TCS WT 4650-4665	21	71	180	509	138
ES 13/10; 6-15 mm	45, 81	TCS 17/12	58, 91	TCS WT 4650-4665-1	21	73Nm/15	180	509IMP	138
ES 14/8; 16-24 mm	45, 84	TCS 20/8;		TCS WT 6501-6602/7	22	80IMP	163	509QR	160
ES 14/10; 6-15 mm	45, 84	6x7-19x22 mm	57, 86	TCS WT 6501-6602/7-1	22	82/013	23	509W	139
ES 20/8;		TCS 20/8;		TR-SCH	18	83/09	23	510	139
6x7-19x22 mm	45, 86	6x7-19x22 mm MF	57, 86	TWBE	208	83/010	23	510IMP	160
ES 20/10;		TCS 20/10;		V 12614	302	86TX	114, 143	510QR	139
6x7-30x32 mm	46, 86	6x7-30x32 mm	57, 86	VE 50-150	14	87a	143	512, 512G, 512SG-QR	137
ES 24/7;		TCS 24/7;		WB620	14	87	142	512QR N	137
8x10-19x22 mm	46, 90	8x10-19x22 mm	57, 90	WB620 FB	14	88TX	114	512QR N/7	137
ES 25/7;		TCS 25/7;		5, 5 1/2	93	89	125	513	139, 331, 334
7x8-17x19 mm	46, 91	TCS 29/6;		8	94	89TX	114, 126, 143	513IMP	160
ES 29/6;		8x9-18x19 mm	58, 93	10, 10a, Sets	78, 79	90/6A	9	514, 514M	139
8x9-18x19 mm	46, 93	TCS 29/7;		12, 12a, Sets	80	95/6	9	514IMP	160
ES 52/17	47, 129	8x9-20x22 mm	58, 93	13, 13a, Sets	80-83	95/7	10	515	137
ES 54/54KK	47, 133	TCS 40/35/9	59, 116	14, Sets	83, 84	95/8	10	517QR	137
ES 54KK/5	47, 134	TCS 40/41/44/8	59, 116	16, Set	85	95VA/6	11	522	137
ES 54X/54TX	48, 135	TCS 40/45/50/89/19	63	17, Sets	90, 91	95VA/7	11	532, 532G	137
ES 55/6/4	48, 147	TCS 40/45/52/78/19	62	20, 20a, Sets	85, 86	95VA/8	12	540, 540a	150, 217, 331, 333, 345
ES 102/105/108/8	52, 284	TCS 49/1049/2049/45TX/49TX	60, 128	21, Sets	88	96/3	14	540aHD	140, 170, 217
ES 102/108/109/4	51, 284	TCS 50a/17	62, 130	21TX	89	98VA/6	12	543	331, 333, 346
ES 456/16/6	47, 127	TCS 50IMP/19/2	64, 158	23, Set	87	98VA/7	13	543	140, 170, 217
ES 721/15/3/2	49, 336	TCS 50IMP/51IMP/19	64, 158	24, 24a	89, 333, 345, 346	98VA/8	13	552	146
ES 1054/2054	48, 133	TCS 50TX/54TX/17	63, 132	25, 25aN, Sets	91, 92	100	100	554	146
ES 1054/2054TX/6	48, 136	TCS 50/51/52/32	61, 130	25aSP	92	102	283	556	146
ES 2309K/3	48, 159	TCS 50/52/30/6 MF	61, 144	25B	92, 169	102, Sets	283	558	146
ES 2309/4	48, 159	TCS 51/11	61, 131	25GK	335	103	284	559	146
ES 4620/4622/4632/8	49	TCS 52/14/4	61, 144	26a	92	104	284	560IMP	161
ES 4620/4628/4630/7	49	TCS 52/17	62, 130	27	89	104-5/6D	284	561	146
ES 4620/4630/8	49	TCS 52/18 MF	62, 130	29, 29a, Sets	92, 93	105	284	561IMP	161
ES 4622-4734/9	49	TCS 54IMP/2307TX/15	64, 158	34c Lkw	336, 344	105-8/6K	285	563	146
ES 46225K/46235K/6	49	TCS 54/2309K/12506	63	35c Pkw	336, 344	108	284	568	146
ES 4650/9	50	TCS 54/54TX/18	62, 135	39 Pkw, Lkw	336, 344	108/6D, 108/6T	285	568IMP	161
ES 4656/9	50	TCS 54/54X/16	63, 133	40D, 40aD	102, 103	109	284	569	146
ES 4660/4665/VDE/6	50	TCS 55/11/6	64, 147	40, 40a, 40DL, 40aDL	102, 103	110	283	569IMP	161
ES 4820/4830/6	50	TCS 102-108/11	70, 285	40-3	332	112, 112/1	283	701/2	193
ES 4820/4830/8	50	TCS 102-108/10956/10960/18	71, 286	40aD/10CL	102	130a	83	712R/6	206
ES 4856/9	50	TCS 102-108/10957/10960 MF	70, 285	40aDL/7	103	130aSP	83	713R	206
ES 6501-6602/7A	51, 271	TCS 102-108/10957/10960/13	70, 286	40aDL/10CL	103	150	280	714	202
ES 6501-6602/7B	51, 271	TCS 102-108/10957/10960/13	70, 286	40aDV, 40L	103, 104	153	280	714R	203
ES 6543-6546/4	51	TCS 102-108/10957/12718/13	70, 285	40aSP, 40aLSP	105	155	280	720Nf	186, 343
ES 10670-13110/11	52, 287	TCS 102-108/10957/12718/13	70, 285	40aD/8/1H	110	157	280, 341	721 Quick	185
ES 10750/10;		TCS 102-108/10957/10960/16	70, 286	40CL	106	165N	281	721Nf	186, 346
6x7-20x22 mm	46, 96	TCS 102-108/10957/10960/16	70, 286	40, 40a, Sets	111-115, 125, 141	180a	87	725/4	209
ES 10768/6	50, 245	TCS 102-108/10960/10	70, 285	40TX	104	220, 220a	88	725B	209
ES 10769/7	51, 246	TCS 102-108/10956/10960/6	69, 285	40TX-E8	333	220aSP	88	725L/5	209
ES 10769B/7	51, 246	TCS 240/6	58, 90	40/7KN, 40/9KN	332	230a	90	725QR VDE	209, 212
ES 10956/10960/2	52, 283	TCS 456/16/4 MF	60, 127	41K	105	240, Sets	87	725QR VDE	353
ES 10956/10970/2	52, 283	TCS 456/16/6	60, 127	44, 44a	105	400, 400QR	108	730	184, 340
ES 12500N/7	50, 239	TCS 456/16/7	60, 127	44K	105	400 Drill	108	730D, 730DR	198
ES TX/32	46	TCS 456/31/8	60, 128	44KTX, 44KTXB, 44P	106	401	108	730Fix	191
H 11030	302	TCS 1054/2054/10	63, 133	44PZ	106	402, 402a	104	730N, 730NR	190, 340
H 11050	300	TCS 1201/4000/10766/38	68	45, 45a	117	402a Set	104	730 Quick	184, 343, 344
K 157	280, 341	TCS 4008/8/52	59	45, 45a, Sets	124-127	402aK	104	730R/40/32 Quick	186, 346
KH 91	14	TCS 4026/3	58, 96	45aP	119	402aSP	105	730R VDE	353
MP300	218	TCS 4620/4630	64, 240	45aSP	119	403	108	731, 731a	210, 212, 214, 215
MP100-1500	218	TCS 4620/4640	65, 240	45aSP	119	404, 404QR	108	732, 732a	210, 213, 215
PZ1221-PZ1223	166	TCS 4620/4660VDE	65, 241	45CL	121	405	108		333, 344
R 90	9	TCS 4620/4660VDE + 10767	65, 241	45TX, Set	119	405QR	108	732/80	215
R 95	9	TCS 4620/4660VDE + 10767	65, 241	45/1KN	152	405W	108	732G	211
R 95/985	14	TCS 4620/4734/8	65, 240	46, 46a	118, 334-335	406	109	732TX	210, 213
R 98	13	TCS 4622/4632	66, 240	46aSP	119	407, 407QR	109	733, 733a	211, 337
R 920	15	TCS 4622/4650 + 10760 + 10766	66, 241	47, 47a	118, 119	409	109	734	209, 212, 214, 340
R 13217	18	TCS 4650	66, 241	47TX	119	409M	109, 233	734/80	215
RI 1500	280	TCS 4660/4665 VDE	66, 356	49, 49a	120	409M/432M/514M/3	109, 233	734F	209
RL 1500, RL 153	280	TCS 4665/4670 VDE	66, 356	49TX, Set	120	410	123, 139	734K	233
RL 1500	280	TCS 4675 VDE	356	49X	129	411	109	734L/5	210
SCH 60-80	15	TCS 4724/4840 + 10767	66, 244	50, 50a	140-143	412	106	735	209, 212, 214, 340,
SCH 90	9	TCS 4751/4752	68	50, 50a, Sets	140-143	412-1	109, 170	736	342, 344
SCH 95	9	TCS 4820/4830	67, 243	50aPLSP	132	413QR	108	737	171, 211, 213, 342
SCH 95VA	11	TCS 4856	67, 244	50CL	136	414H	110	755, 755R/1	213, 214
SCH 98VA	12	TCS 6501/6551/6600 VDE	356	50D IMP	158	415	106	759IMP	162
SD 10351N	315	TCS 6501-6600/3 VDE	69, 356	50IMP	158	415B	107, 169	760	179
SDH 95	11	TCS 6501-6602/3	68, 272	50IMP Set	158	415QR	107	768IMP	163
SDH 98	14	TCS 6501-6602/4	68, 272	50TX, Sets	131, 143, 339	415QR N	107	771IMP	162
SDH 921	15	TCS 6501-6602/4N	69, 272	50/3KN, 50/4KN, 50/6KN	152	415QR N	107	775	175
SmartCheck	221	TCS 6534-6545/6	69, 272	50/5	152	415QR N/7	107	801N	25
SP 11040	303	TCS 6543-6546/4	69, 272	51, 51a	130, 331, 334, 340, 345	4155GB N	107, 169	802N	26
SP 11050	303	TCS 10356-12965/5	71, 288	51aP	132	4155GH N	107, 169	803N	27
SP 11053	303	TCS 10750/10;		51S	131, 335, 336	416QR	110	804N	27
SP 11055	303	TCS 10760-10771/26	68	51IMP	158	417/1			

No	Page	No	Page	No	Page	No	Page	No	Page
905/25, 906	288	3316/1	170	6533 VDE	358	7762-1	203	12179/9/4 VDE	352
910	14	3316/1QR	170	6534	257	7787	233	12187 VDE	360
912	14	3466	118, 334	6535	257	7788	233	12188 VDE	360
913	15	3505	139, 331	6536	257	7789	139, 233	12189 VDE	360
913/4	10	3678	345	6537	257	7790	227	12190 VDE	360
913/95	14	3825/1	170	6538	258	7791	226	12191 VDE	360
913/98	14	4000	168	6540	273	7791-1	226	12192 VDE	360
920	15	4004	95	6543	258	7791-2	227	12193 VDE	360
920 C	15	4006/1	168	6544	258	7792	227	12194 VDE	360
920 C-SCH	15	4007	169	6545	259	7792-1	227	12195 VDE	360
922N	15	4008	110, 169	6546	259	7794	229-231	12196 VDE	360
1015	338	4008/27/1R	110, 169	6547	259, 340	8002	24	12200	287
1023	331	4014	85	6549	261	8031-8041	24	12250, 12251	290
1049	120, 337	4025, 4026	95, 96	6551	260	8050	24	12320, 12321	290
1054	133	4030-4036	172	6551 VDE	358	8091/1IMP	163	12322	291
1054-10	333, 340, 345	4040-4044	172	6554	260	8092/1IMP	163	12371	337
1054-13	331, 339	4050-4058	172	6556	261	8820	148	12373	337
1054KK	134, 339	4060	172	6557	261	10350N	315	12374	291
1054TX	136	4110	107	6558	261	10351N	315	12375	335
1054TX/4T	136	4150	107	6559	262	10351/1	315	12377	291
1054x	135	4150B	107	6561	262	10351/2	316	12378	291
1058	339	4150QR	107, 219	6562	262	10351/3	316	12481	291
1062	331	4150QR N	107	6562/1, 6562/2	262	10352	315	12495	334
1068	345	4204	95	6563	263	10352/1	315	12500N	239
1100 TCS	326	4205, 4205a	94, 95	6564	263	10354, 10355	316	12503	168
1120 TCS	327	4350	121	6565	263	10356	316	12504	168, 331
1120/1 TCS	329	4350QR	122, 219	6566	263	10356R	316	12506	239, 342, 343
1120/2 TCS	330	4350QR N	122	6567	263	10503	330	12507-2K	246
1120/3 TCS	330	4600	118, 334	6568	264	10506	330	12600	291
1157-1169	166	4606	118, 334	6571	264	10507N KK	238, 330	12613, 12614	302
1200/1	170	4620	237	6572	260	10518	331	12615	289
1201	168	4621	237	6573	260	10546	247	12616	303
1204/8	167	4622	237	6575	264	10551	247	12623-1, 12623-3, 12623-4	303
1204/21-1	168	4622SK	237	6576N	264	10554	249	12665	289
1204/21-2	168	4628	237	6600	265	10599/2	336	12705	332
1218-1223	166	4630	237	6600 VDE	358	10613	337	12717	341
1225	123, 151, 217, 341	4631	237	6601	265	10613/1	337	12718	316, 341
1231-1234	166	4632	237	6602	265	10614	341	12727	314
1242-1250	171	4632SK	238	6602 VDE	359	10615/1	341	12728, 12729/12730	314
1260-1262	171	4636	238	6603	273	10623/1, 10623/2	341	12731	332
1270-1272	171	4640	238	6604	274	10625	341	12749, 12749R	316
1280-1284	171	4650	238	6605	273	10625/2	341	12752	314
1290-1296	171	4650L	238	6606	274	10626	335	12753	314
1299	167, 208	4656	238	6607	274	10669, 10670, 10672, 10676	286	12763	342
1300-1304	167	4660 VDE	355	6612	266	10750, Sets	96	12770, 12770/2, 12770/3	314
1350, 1356-1360	166	4665 VDE	355	6613	274	10750 1/2	96	12771	342
1407-1421	166	4670 VDE	355	6614	275	10757	249	12800	287
1417	166, 334	4675 VDE	355	6615	275	10758	249	12900N	289
1418	166, 339	4691/7	239	6617	266	10759, 10759a	110	12900/1N	289
1421	166, 344	4692/8	239	6618	266	10760CV	247, 248, 343	12900/3, 12900/4	290, 337
1427	167	4693/9	239	6619	275	10760aCV	247	12905	335
1430-1446	166	4694/9	240	6620	275	10760CV, 10760aCV, Sets	247, 248	12910	291
1435	166, 342	4695 VDE	356	6621	275	10765, Set	248, 339	12915	292
1436IP-1446IP	167	4696/6	239	6622	268	10766, Set	248	12920N, 12920NR	291, 292
1440TPI-1446TPI	166	4697/8	240	6623	268	10767, 10767a, Sets	249	12921M	291
1440-1446	166	4699/9	237	6623 VDE	359	10767H, Set	249	12921N, 12921NR	292
1441TN-1446TN	171	4724	237	6624	268	10768	245	12922E	292
1445	342	4734	238	6630	268	10768-2K	245	12932	290
1474/2	316	4744	238	6630 VDE	359	10769	245	12935	290
1501-1506	308	4751	244	6634	269	10769B	246	12941N	292
1511-1518	308	4752	244	6637	269	10771, Set	248, 249	12941R/4	292
1523	308	4753	244	6638	269	10775-10795	311	12943N	292
1551-1555	308	4797	244	6639	269	10800-10842	311, 312	12943R	292
1556	308	4798	244	6640	269	10845-10890	312, 313	12965N	292
1556-1	309	4798 VDE	356	6641	270	10895	313	12965R	293
1557/1558	309	4820	243	6660	270	10905-10908	313	12965-1	293
1559	309	4830	243	6661	270	10915, 10916	313	12965-2	293
1560	310	4840	243	6662	270	10921	313	12965-2R	293
1562	309	4856	243	6670-6674	267	10922	313	12965-3R	293
1570/1, 1570/2	310	4891	243	6676, 6677	267	10923	313	12967, 12967R	293
1574-1578	309	4892	243	6702	271	10940	282	12975	342
1584/1585	309	4899	243	6703	271	10955, 10955R	282	13006	172
1587	310	5040	138	6704	271	10956, 10956R	282	13008	167
1589K	310	5040N	138	6705	271	10957, 10957R	282	13010	167
1591	310	5091IMP	160	6706	271	10958	282	13100	297
1650N, 1650K	281	5092IMP	160	6923	268, 359	10960	282	13110	290
1651	281	5100	118, 130, 335	6954	260	10970	283	13115	291
1652N	281	5120+7210/15	137, 220	6962	262	11005-11007	313	13120N	292
1655N, 1656N	281	5120G	137	6966	260	11030	302	13120R	292
1700	310	5120QR	138, 219	6976	274	11040	301	13126-1	293
1820	211	5120QR N	138	7091IMP	163	11041	303	13126-2	294
1821	213	5120QR N80	138	7092IMP	163	11042	301	13126-3	294
1829	215	5513	111, 123, 139	7160	203	11050	300	13128	294
2049	120	5520	146	7195-2	203	11051, 11053, 11054	300	13130, 13131	294
2054	133	5591IMP	161	7210	220	11055	301	13148	294
2054X	134	5592IMP	161	7250/4	219	11056	300	13200a	29
2054TX	136	6091IMP	162	7250L/5	219	11060	301, 334, 340, 343	13205a	30
2307TX	159	6092IMP	162	7250QR	219	11061	302, 334, 340, 343	13207a	30
2308TX	159	6501	253	7301, 7302	208	11062	302	13208a	31
2309	159, 336	6501 VDE	357	7303, 7304	208	11063, 11063/1	332	13209	25
2309K	159, 336	6507	253	7311/7312	233	11068	332, 345	13209 VDE	360
2500TCS	318	6507 VDE	357	7313/7314	233	11069	331	13210	31
2501N TCS	320	6508	253	7350	212, 138, 219	11085	332	13211a	32
2502 TCS	322	6508 VDE	357	7370	211, 213-215	11095-11097	332	13213a	32
2509	160, 345	6509	253	7380N, 7385N	208	12000	288	13214	36
2609	161, 345	6510	254	7395-1	199	12005, 12007	338	13214aWT/LR	37
2801	171	6511	254	7396	199	12025	287	13214aWW	38
3000	331	6512	254	7396 PC	225	12035	287	13214WT/LR	34
3004	333	6513	254	7706PC	222	12036	287	13214WW	35
3022 TCS	324	6515	261	7721-7724	223	12050, 12050R	287	13216	27
3026 TCS	322	6516	254	7728	231	12053, 12053R	287	13217	18
3027	28	6517	273	7732-2	203	12108	332	13217TA	18
3045	338	6518	255	7750	232	12150, 12152	301	13220	123
3045K	338	6519	255	7750-1	227	12160 VDE	354	13221WT/TS	39
3046	338	6522 VDE	359	7751	232	12160/6 VDE	354	13224aWT/TS	40
3047	335	6523	255	7751-1	199, 207, 232	12161 VDE	355	13300 VDE	352
3049-8	120, 340	6523 VDE	357	7751-2	199, 232	12161/6 VDE	355	83812021-83812089	45-52
3049X	120	6524	255	7752	232	12165 VDE	353		
3054	133	6524 VDE	357	7756	232	12167 VDE	354		
3054X	134	6525	255	7757-1	199, 207	12171 VDE	353		
3054X-M10	333, 334	6526	273	7757-4	199, 207	12171/19/4 VDE	352		
3054X-M12	333, 345	6529	256	7759-5	199, 207	12173 VDE	353		
3054X/54X/8	134	6529 VDE	358	7760	232	12174 VDE	354		
3115	169, 170	6530	256	7761	232	12175 VDE	354		
3116/1	170	6530 VDE	358	7761/3	203, 232	12177 VDE	354		
3116/1QR	170	6531	256	7762	203	12179 VDE	354		
3216/1	170	6532	256						
3216/1QR	170	6533	257						

A

Accessories

- 1/4" □ **106-110**
 - 3/8" □ **121-123**
 - 1/2" □ **137-139**
 - 3/4" □ **146**
 - 1" □ **148, 149**
- Adaptors **109, 123, 139, 146, 149, 160-163, 170, 172, 211, 213-215, 217, 331, 334**
Air filter claw **345**
Angle module **199**
Automotive voltage tester **335**

B

- Balance weight pliers **336**
Ball joint separators **303**
Ball ended hexagon driver **238, 249, 330**
Bar handle **146, 148**
Battery terminal pullers **301**
Bearing scraper **286**
BIT holder insert tool **171, 211, 213, 342**
BIT ratchet **107, 169**
BITS box **168**
BITS for
- 5-star screws **167**
 - inside hexagon screws **167, 171, 172, 208**
 - Phillips® screws **166, 171, 172**
 - POZIDRIV/SUPADRIV® screws **166, 171**
 - slotted screws **166, 171, 172**
 - TORQ-SET® screws **167**
 - TORX PLUS® screws **167**
 - TORX® screws **166, 167, 171**
 - tri-square socket head screws **166**
 - TRI-WING® screws **167**
- BITS holders **109, 123, 140, 168-171, 331**
BITS screwdrivers **166, 167, 171, 172**
Blank end insert tool **211, 213, 214**
Body files **313**
Body spoons **313**
Box spanners **96**
Boxes, empty **152**
Bradawls **249**
Brake caliper brush **337**
Brake caliper file **337**
Brake spring pliers **337**
Brass punch **334**
Brass wire brush **291**
Bumping spoons **313**

C

- Cable extractor tools KABELEX® **308-310**
Cable holder **14**
Cable knife **290**
Cable shear **268, 359**
Calibrating square drive insert tools **233**
Calibrating square drive units **233**
Calibrating systems **225-231**
Calibration software **203, 207**
Carburettor screwdriver **237, 330, 331**
Carburettor tools **237, 330, 331**
Car circuit tester **335**
Centre punches **284**
Chain pipe cutter **280, 341**
Charger for Li-ion battery **203**
Circlip pliers, inside and outside **258, 259, 340**
Clamping block **281**
Clamping screw **281**
Claw lifter **292**
Clip strips **102, 103, 106, 121, 136**
Cold chisels **283, 284**
Combination pliers **253, 357**
Combination spanners **80-85**
Compartment shelf **14**
Connecting pins (for sockets) **160-163**
Connector pliers **264**
Container **24**
CONVERTA-modular system **15**
Counter stays for puller **302, 343**
Cover **15, 18**
Crimping pliers **269, 270**
Cross cut chisels **283**
CROW-FOOT spanners **150, 151, 215, 217, 331, 333, 346**
CROW-RING spanners **149, 150, 216, 342, 345, 346**
Cutter **293**
Cutting wheels **280**

D

- D/E flexi joint spanners **92, 93**
D/E open ended spanners **78-80**
D/E ring spanners **85-90**
Dinging hammer **311, 312**
Docking station for MANOSKOP® **203**
Dollies **312**
Double flaring tool **281**
DRALL screwdrivers **237-244**
Draw handle **315**
Drawer separator **14**
Drawers **9, 11, 12, 15, 18**
Drift pins **284, 285**
Drive handle **108**

E

- Ear clamp pliers **341**
Ejection tools KABELEX® **308-310**
Electricians cable knife **290**
Electricians screwdrivers **237, 355, 356**
Electronics flat nose pliers **273**
Electronics oblique cutters **274, 275**
Electronics screwdrivers **244**
Electronics side cutters **273, 274**
Electronics snipe nose pliers **273**
Electronics top cutters **275**
Embossing hammer **282**
Empty inlays **52**
Empty tray for small components **14**
Engineers files **287**
Engineers hammers **282, 283**
Engineers scrapers **286**
EXPRESS pipe cutters **280**
Extensions **108-110, 122, 123, 138, 139, 146, 149, 151, 160-163, 302**
Extensions with wobble-drive **108, 122, 138**
Extensions, flexible **109, 123**
Extractor pliers **342**

F

- FastRatch ratchet wrenches **90**
Feeler gauges **332**
File blades **313**
File brush **291**
Files **287, 313**
Fine scraper **286**
Finger protector(-chisels) **283**
Flaring cones **281**
Flaring spindle **281**
Flat engineers scraper **286**
Flat (gasket) scraper **316, 341**
Flat nose pliers **253, 254, 273, 357**
Flexible drive handle **108**
Flexible handles **108, 122, 138**
Flexible heads **146, 148**
Flexible ratchets **107, 121, 137**
Flexi-joint spanners **92, 93**
Friction gauge **180**
Fuel hose clamp **342**

G

- Gauges **180, 208, 289, 332**
Grinding tools **332**
GRIPMAT **10**
Gripping pliers **255, 262-264**
Grooving chisels **283**
Guide handle **316**

H

- Hacksaw and blades **287**
Hacksaw frame **287**
Hammers **282, 283, 311**
Hand vice **287**
Heavy duty pipe wrenches **261**
Heavy duty ring spanners **94, 95**
Heavy duty side cutters **265, 359**

- Heavy duty steel fixer pincers **270**
Heavy duty top cutters **266**
Hexagon key wrenches **245, 247-249**
Hexagon nut spinners **239, 246**
 - with T-handle **246**

Hi-Lok-Tools **110**
Holding device (for spanners) **24**
Hooks **24**
Hook spanner, adjustable **291**
Hose clip pliers **341**

I

- IMPACT accessories **160-163**
IMPACT driver/set **172**
IMPACT sockets
- 1/2" □ **158, 159**
 - 3/4" □ **160**
 - 1" □ **161**
 - 1 1/2" □ **162**
 - 2 1/2" □ **163**
- IMPACT INHEX Sockets **159**
INHEX sockets **105, 120, 132-134, 145, 148, 331, 333, 337, 339, 340, 345**
INHEX sockets for Ribe-CV® **134**
Inlays, empty **52**
Insert tools for MANOSKOP® torque wrenches **209-217**
Insert tools for TORSIOMETER/TORSIOMAX **171, 172**
Interface adapter, set **203, 232**
Internal pullers **301**

J

- Jack cable **199, 207, 232**
Jet reamers **331**

K

- KABELEX® ejection tools **308-310**
Key wrenches **248, 249**

L

- LED headlamp **294**
LED penlight **294**
LED torch **293, 294**
LED-lighting for torque wrenches **208**
Lever action top cutters **266**
Lever bar **313, 314**
Li-ion battery for MANOSKOP® **203**
Locking adaptor **109, 122**
Lubrication service tools **338, 339**

M

- Magazine case **15**
Magazine drawer **15**
Magnetic lifters **291**
Mains adaptor **232**
MANOSKOP® torque wrenches **180-203**
Manutork **226, 227**
Mechanics flat nose pliers **254**
Mechanics gripping pliers **255**
Mechanics oblique cutter **266**
Mechanics round nose pliers **255**
Mechanics snipe nose pliers **256-258, 358**
METAL pipe cutter **280**
Mini-electronic side cutter **274**
Mini-waterpump pliers **261**
Multiplex beechwood worktop **14**
MULTIPOWER **218**

N

- Needle files **287**
Needle pliers **257**
Non-slip mat GRIPMAT **10**
Nut spinners **239, 246**
Nut splitters **289**
Nylon hammers **282**

O

Oblique cutters **266, 274, 275**
 Offset screwdrivers **110, 247**
 Oil cans **290**
 Oil filter claw **338**
 Oil filter wrenches **338**
 Oil service spanner **339**
 Open ring insert tools **211**
 Open ring spanners **89, 90**

P

Padlock **290**
 Panel beating tools **311-314**
 Pecking hammers **311**
 perfectControl calibrating unit **229-231**
 Perforated panel **24**
 Phillips® BITS **166, 171, 172**
 Phillips® screwdrivers **237, 238, 243, 244, 247**
 Pincers **270**
 Pin punches **284, 285**
 Pin wrench **341**
 Pipe cutters **280, 341**
 Pipe cutter wheels **280**
 Pipe wrenches **261, 262**
 Planishing hammers **311**
 Plastic case, empty **208**
 Plastic hammers **282**
 Plastic lever bar **314**
 Plastic side cutters **267**
 Pliers **253-275, 356-359**
 PowerGRIP pliers wrench **260**
 Pozidriv/Supadriv® bits **166, 171**
 Pozidriv/Supadriv® screwdrivers **238, 243**
 Precision feeler gauges **332**
 Pry bar **313**
 Pullers **300-302**
 Pull hook **342**
 Piston ring compressors **332, 345**

Q

Quick-change BIT holder **170**
 QuickRelease drive handle **108**
 QuickRelease extensions **108, 122, 139**
 QuickRelease ratchet insert tool **209, 212**
 QuickRelease ratchets **106, 107, 121, 137**
 QuickRelease safety lock **208**
 QuickRelease sliding T-handle **108, 122, 138**
 QuickRelease speeder brace **108, 122, 138**
 QuickRelease universal joint **109, 123, 139**

R

Ratchet adaptor **121, 137, 146**
 Ratchet ring spanners **90, 91, 92**
 Ratchet spares **107, 121, 122, 137, 138, 146, 148, 219, 220**
 Ratchet tap holders **290**
 Ratchet wrenches **90, 92, 169**
 Ratcheting bit holder **92, 110, 169**
 Ratchets **106, 107, 110, 121, 137, 146, 148, 169**
 Relay pliers **254**
 Replacement milling cutter **314**
 Ring insert tools for torque wrenches **210, 211, 213, 214**
 Ring spanners
 – deep offset **85, 86**
 – open **90**
 – shallow offset **87**
 – straight **88, 92**
 – TORX® **89**
 Round nose pliers **255, 273, 357**
 Rubber composition hammer **282**
 Rubber inserts (for sockets) **118, 130**
 Rubber rings (for sockets) **160-163**
 Rubbish bin **12, 13**

S

Safety knife **292**
 Scrapers **286, 291, 316, 341**
 Screw extractors **289**
 Screw pitch gauge **289**
 Screwdrivers **237-249, 330, 331, 355**

Screwdriver sockets **105, 106, 120, 134-136, 145, 171, 331**
 Scriber **290, 291**
 Self-grip wrenches **262-264**
 Self-retracting cutter **293**
 SENSOMASTER software **203, 207**
 SENSOTORK® **193, 206, 222**
 Separating fixture **302**
 Service MANOSKOP® torque wrenches **184, 190, 191**
 Set of reversible screwdrivers **244, 356**
 Set of wheels **9, 10, 13-15, 18**
 Shell tools for Manoskop® torque wrenches **214, 215**
 Side cutters **265, 273, 274, 358**
 Single-end spanners, adjustable **95, 96**
 Single O/E spanners **95**
 Slide hammers **302**
 Sliding heads **146, 148**
 Sliding T-handles **108, 122, 138**
 Small bore pipe cutter **280**
 Snap-off blade cutter **293**
 Snipe nose pliers **256-258, 273, 358**
 Sockets
 – 1/4" □ **102-106**
 – 3/8" □ **117-120**
 – 1/2" □ **129-136**
 – 3/4" □ **145**
 – 1" □ **148**
 – multi-spline **331**
 – spline-drive **105, 119, 132**
 – 4 pin **345**
 Socket sets
 – 1/4" □ **110-115**
 – 3/8" □ **124-127**
 – 1/2" □ **140-143**
 – 3/4" □ **146, 147**
 – 1" □ **149**
 Software for calibration **203, 207**
 Soldering gun **292**
 Soldering iron **292**
 Spacing washers **280**
 Spare cutting wire **315**
 Spare parts for pipe cutters **280**
 Spare parts for ratchets **107, 121, 122, 137, 138, 146, 148, 219, 220**
 Spare plastic heads (for hammers) **282**
 Spare nylon heads **282**
 Spark plug brush **335**
 Spark plug connector pliers **335**
 Spark plug sockets **118, 334, 335**
 Special extensions **123, 139, 341**
 Special socket **172**
 Special tools for brakes and wheels **336-339**
 Special tools for carburetors **237, 330, 331**
 Special tools for cars and trucks **308-346**
 Special tools for chassis **333, 334**
 Special tools for engine and gear transmission **339-341**
 Special tools for HGVs **344-346**
 Special tools for ignition and electrics **334, 335**
 Special tools for lubrication service **338, 339**
 Special tools for pistons **332, 333**
 Special tools miscellaneous **341-344**
 Speeder braces **108, 122, 138**
 Spinner handles **168**
 Spinner with bits magazine **168**
 Spiral cable **232**
 Spline drive combination spanners **83**
 Spline drive ratchet ring spanners **92**
 Spot weld drills **314**
 Spot weld milling cutter **314**
 Spray-can and paper-roll holder **15**
 Spray-can holder **11, 14**
 Spring clip **24**
 Square drive adaptor **233**
 Square lug **24**
 Standard-MANOSKOP® torque wrenches **185, 186**
 Steel fixers pincers **270**
 Steel rule **290**
 Stethoscope **332**
 Stillson pipe wrenches **262**
 Strap wrenches **338**
 Striking face spanners **95**
 Striking face ring spanners **94, 95**
 Stud remover **288, 289**
 Suction lifter **315**
 Swedish pattern wrenches **261**

T

Tape measure **290**
 Telescopic mirrors **291, 292**
 Tension strap with ratchet **316**
 Testing tools for car electrics **335**
 Thread restorers **288**

Three square bearing scraper **286**
 Three square scraper **286**
 Tin snips **314**
 Tommy bars **96**
 Tool box trolley **23**
 Tool boxes **23**
 Tool cases **25**
 Tool holder **211, 213, 215**
 Tool magazines **15**
 Tool sets **18-22, 25-71, 317-330**
 Tool trolleys **9-13, 17**
 Tools for fitting/removing vehicle glass **315, 316**
 Tools for heater plugs **335**
 Tools for vehicle doors **314**
 Top cutters **266, 275**
 Torches **293, 294**
 TORQ-Set™ screwdriver **238**
 Torque angle gauges **208**
 Torque screwdrivers **179**
 Torque test equipment **221-233**
 Torque wrenches **180-206**
 TORSIOMAX torque screwdriver **179**
 TORSIOMETER torque screwdriver **179**
 TORX PLUS®-bits **167**
 TORX®-bits **166, 167, 171**
 TORX®-insert tools **210, 213**
 TORX®-screwdrivers **238, 240, 243, 245, 246, 355**
 TORX®-sockets **104, 106, 119, 120, 131, 135, 136, 145**
 Transducer **223, 231**
 Trays, empty **152**
 Tubular handles **93**
 Tubular hacksaw **287**
 Tweezers **294**
 Tyre levers **336, 344**
 Tyre tread Vernier calliper **290, 337**

U

UNIFLEX-sockets **104, 105, 118, 119, 131**
 Universal joints **109, 123, 139, 146, 160-162**
 USB adaptor **199, 207, 232**

V

Valve adjustment tools **332, 333**
 VDE insulated pliers **357-359**
 VDE insulated screwdrivers **355**
 VERITRAC windscreen removal set **315**
 Vernier calliper **289**
 Voltage tester **249**



W

Warding files **287**
 Waterpump pliers **260, 261, 358**
 Wheel braces **336, 344**
 Wheel fitting set **185**
 Wheel hub puller **302**
 Wheel nut sockets **159**
 Wheely box **15**
 Windscreen removal set, VERITRAC **315**
 Wire brushes **291, 337**
 Wire cutter **294**
 Wire insert awl **316**
 Wire insert probe **316**
 Wire stripping knife **293**
 Wire stripping pliers **268, 359**
 Wire twisting pliers **264**
 Work benches, mobile **14**
 Workshop sets **18-22, 25-71, 317-330**

Assignment of spanner sizes to screws

Spanner opening SW		Metric sizes													American sizes													
		Thread diameters													Thread diameters - American standard ANSI													
		DIN ISO 272			ISO R 272 1968		German standard DIN			French standard	Swedish standard				Nuts				Bolts and screws									
Minimum dimension (mm ¹)	Maximum dimension (mm ²)	Nominal size of wrench, mm	Standard hexagon	Large hexagon	Screw with flange	Nut with flange	Normal hexagon	Small hexagon	Normal hexagon ³	Large hexagon ³	Small hexagon ³	Screw with flange ³	Nut with flange ³	NFE 27-111-1930 ⁴	Metric, large ⁵ SMS 1412	Metric, small ⁶ SMS 1414	Whitworth, large ⁶ SMS 1413	Whitworth, small ⁶ SMS 1415	Nominal Size of Wrench	a Normal (No)	b Square (No)	c Heavy (No)	d Machine Screw Nuts (No)	e Normal (No)	f Heavy (No)	g Machine Screws (No)	h Square Head Set Screws (No)	
3.22	3.28	3.2	1.6				1.6		1.6										1/8								1-2-3	
3.23	3.35																											
3.52	3.60	3.5												2.5					5/32			0-1						
4.01	4.14																	2.3										
4.02	4.12	4	2			2		2										2.6										
4.52	4.62	4.5																										
4.83	4.95																			3/16			2-3				3-4-5	10
5.02	5.12	5	2.5			2.5		2.5						3				3										
5.21	5.33																											
5.52	5.62	5.5	3			3		3																				
5.59	5.72																											
6.00	6.13																											
6.03	6.15	6							3.5					3.5	3		3.5											
6.40	6.53																											
6.82	6.97																											
7.03	7.15	7	4	5		4		4						4-4.5	3.5	4												
7.19	7.32																											
7.62	7.77																											
8.03	8.18																											
8.03	8.15	8	5		6	5	5		5		6	5	5	5	4		5											
8.41	8.56																											
8.81	8.97																											
9.03	9.15	9						(5) ₇						5.5	5													
9.60	9.75																											
10.04	10.19	10	6		8	6	6		6		8	6	6	6		6												
10.39	10.55																											
11.04	11.19	11	7			7		7							6	7		1/4										
11.18	11.33																											
11.99	12.14																											
12.04	12.24	12						8						7				8										
12.80	12.95																											
13.04	13.24	13	8		10	8	8		8		10	8	8				1/4	5/16										
13.60	13.77																											
14.05	14.27	14						10	(8) ₇					8	8													
14.38	14.55																											
15.05	15.27	15			12	10						10	10				10	5/16	3/8									
15.18	15.36																											
15.98	16.15																											
16.05	16.27	16	10	SP-M10 M14				10		12	12		9															
16.77	16.95																											
17.05	17.30	17				10	12	(10)		(12)				10	10													
17.58	17.75																											
18.05	18.30	18	12	SP-M12	14	12			12		16	14	12				12	3/8	7/16									
19.06	19.36	19					12	14	(12)		(16)			11														
19.18	19.38																											
19.97	20.17																											
20.06	20.36	20																										
20.78	20.98																											
20.86	21.16	20.8		SP-M14 M18																								
21.06	21.36	21	14	12	16	14			14	12		16	14	12		14	7/16	1/2										
22.06	22.36	22					14	16	(14)	12						12-14												
22.35	22.56																											
23.06	23.36	23												14			1/2											7/8
23.98	24.21																											
24.06	24.36	24	16	14		16	16	18	16		20		16			16		5/8										
24.76	24.99																											
25.06	25.36	25																										
25.55	25.78																											
26.08	26.48	26		SP-M18										16														
27.08	27.48	27	18	16	20		18	20	18	16		20			16	18												
27.13	27.36																											
28.08	28.48	28														5/8	3/4											
28.75	29.01																											
29.08	29.48	29												18														1 1/8
30.08	30.48	30	20	18		20	20	22	20		24		20			20												
30.34	30.59																											
31.93	32.18																											
32.08	32.48	32					22	24	(22)	20				20	18-20	22												1 1/4
33.08	33.48	33														3/4	7/8											
33.53	33.81																											
34.08	34.48	34	22	20				22	20							24												
35.10	35.60	35												22														
35.13	35.41																											
36.10	36.60	36	24	22		24	27	24	22	30					22-24													1 3/8

Symbols used throughout this catalogue

Symbols	Special Tools for
	
Spanner Opening	Carburettor, fuel injection systems
	
Spanner Opening for Hexagon Socket Head Screws	Valves, pistons
	
TORX® size in mm	Chassies, steering
	
Outside Square	Car bodies
	
Inside Square	Ignition, electric, electronic
	
Inside Hexagon	Brakes, wheels
	
Outside Hexagon	Lubrication service
	
Pipe Diameter, inside	Engine, drive train
	
Pipe Diameter, outside	Other tools
	
Size of Insert Tool Carrier in mm (MANOSKOP®) (Inside Square)	
	
Size of Shell Tool Carrier in mm (MANOSKOP®) (Outside Square)	
	
Open Ring Spanner, hexagon	
	
Open Ring Spanner, bi-hexagon	
	
Socket, hexagon	
	
Socket, bi-hexagon	
	
Socket, hexagon, AS-drive	
	
Socket, bi-hexagon, AS-drive	
	
Socket, bi-square	
	
Socket, spline-drive	
	
for Socket Head Screw, hexagon	
	
for Socket Head Screw, hexagon with guide pin	
	
for Phillips-Recessed head Screws Phillips-Recess®, registered trademark of Phillips Screw Company	
	
for POZIDRIV/SUPADRIV Screws POZIDRIV/SUPADRIV®, registered trademark of European Industrial Services Ltd.	
	
for Trisquare Socket Head Screws	
	
for Inside TORX® Screws	
	
for Inside TORX® Screws with hollow drive tip	
	
for Inside TORX PLUS® Screws	
	
for 5-star screws	
	
for Outside TORX® Screws	
TORX® registered trademark of Fa. Acument Intellectual Properties, LLC, Rockford, Illinois, USA STAHLWILLE holds the Manufacturing Licence for TORX® Tools	
	
for Spline Socket Head Screws Ribe-CV®, registered trademark of Richard Bergner GmbH & Co.	
	
for Slotted Head Screws	
	
for TRI-WING® Screws , registered trademark of Phillips Screw Company	
	
for TORQ-SET® Screws , registered trademark of Phillips Screw Company	
	
Diameter in mm	
	
Anti-Slip-drive	
	
High-Performance-Quality	
	
Scale Range	
	
Scale Division	
	
Weight	
	
Standard Pack (pieces)	
	
full flush cutting	
	
semi flush cutting	
	
standard bevel	
	
Safety insulated as per IEC 900 - AC 1000 V	
	
new items	

STAHLWILLE Eduard Wille GmbH & Co. KG

Lindenallee 27

P.O. Box 120103

42349 Wuppertal

Germany

Tel.: +49 202 4791-0

Fax: +49 202 4791-200

info@stahlwille.de

www.stahlwille.de

WEEE-Reg.-Nr. DE 70431151

We reserve the right to alter dimensional details in order to carry out improvements.

All photographs used in this catalogue represent the tools as closely as possible to their natural appearance. Model changes may take place without prior notice as in the case of design improvements. We observe all legal requirements relating to tools and safety.

All rights reserved.

E & OE

Printed in Germany -

Copyright by

STAHLWILLE Eduard Wille GmbH & Co. KG

Wuppertal

